

Preface

- Thank you for purchasing this AC servo driver.
- This Manual is the user manual for K/iK series products.
- To use this series of servo drivers correctly, please carefully read this Manual before use and keep this Manual properly for future reference. If this product is purchased for your customer, please send this product to the final user together with this Manual.









☆ Warm tips:

- ◇ For the user who uses this product for the first time, please carefully read this Manual. If there is any question with the function or performance of this product, please contact our technical support staff for help in order to use this product correctly.
- ◇ We have tried our best to improve the contents of this manual. However, if you find any problem in this Manual, please contact our technical support staff in time for us to make timely corrections.
- ◇ As we will constantly improve our servo driver products, we may make changes to the materials without prior notice.
- ◇ Without prior written consent of the Company, no part of this manual shall be reproduced.









Safety Precautions

Before product storage, installation, wiring, operation, check or maintenance, users must be familiar with and observe the following important notes to ensure safety during use of the product.

1. Electric Shock Injury Warning

 Warning
<p> When the servo driver is powered on, the machine casing should not be opened so as to avoid electric shock.</p>
<p> When the casing is opened, the servo driver should not be powered on so as to avoid electric shock resulting from exposed high voltage wire.</p>
<p> In maintenance of the driver, wait for at least five minutes after cutting off the power, and detect both ends of the high-voltage capacitor using a voltmeter. The maintaining operation is allowed only when it is confirmed that the safe voltage range is reached.</p>
<p> Power on only after reliable installation of the driver.</p>
<p> Servo driver and servo motor must be reliably grounded.</p>
<p> Do not touch the driver with wet hands for fear of electric shock.</p>
<p> Wrong voltage or power supply polarity may cause an explosion or operational accidents.</p>
<p> Ensure that the wire is properly insulated to avoid squeezing the wire and electric shock.</p>

2. Warning of Damage to Equipment

 Warning
<p> Do not directly connect power to the U, V or W terminals of the driver for fear of damaging the driver.</p>
<p> The servo motor and servo driver should be directly connected. Do not connect the U, V or W output ends of the driver to any capacitive element (e.g. noise suppression filter, pulse interference limiter, etc.) for fear of improper work of the driver.</p>
<p> Connect the input end of the driver to a compliant power supply as required.</p>
<p> Please verify the correctness and reliability of the cable connections before energizing.</p>
<p> Please purchase and use motor as required, or damage to the driver or motor may occur.</p>
<p> The rated torque of the servo motor should be higher than the effective continuous load torque.</p>
<p> The ratio between the load inertia and servo motor inertia should be less than the recommended value.</p>

3. Fire Warning



Warning

 The driver should not be installed on the surface of a combustible and should be kept away from flammable materials. Otherwise, a fire accident may occur.

 Do not use it at a place which is damp, full of corrosive gas or flammable gas for fear of a fire.

 When any abnormal situation occurs while the driver operates, please immediately cut off the power for repair. Long-time overloaded operation of the driver may cause damage and fire.

Contents

Contents	4
Chapter I Function Overview	1
1.1 Description of Servo Driver Models	1
1.2 External Dimension	1
1.3 Basic Functions	2
Chapter II Installation and Dimension	3
2.1 Servo Driver	3
2.1.1 Storage Condition	3
2.1.2 Installation Site	3
2.1.3 Installation Direction	3
2.1.4 Installation of Several Servo Drivers	3
2.1.5 Dimension Description	4
2.2 Servo Motor	5
2.2.1 Storage Temperature	5
2.2.2 Direction	5
2.2.3 Installation Concentricity	6
2.2.4 Installation Direction	6
2.2.5 Protection Measures against Water and Oil	6
2.2.6 Cable Tension	7
Chapter III Wiring	8
3.1 Wiring of Main Circuit	8
3.1.1 Descriptions of Terminals	8
3.1.2 Typical Examples for Main Circuit Wiring	9
3.2 Encoder Signal Wiring	11
3.2.1 Connection with Encoder Interface (CN1/CN2) and Processing of Output Signal from CN3	12
3.3 Input/Output Signal Wiring	14
3.3.1 Velocity/Torque Control Mode	14
3.3.2 Position Control Mode	16
3.3.3 Signals and Their Functions for Input/Output Connector (CN3)	17
3.3.4 Interface Circuit	18
3.4 Other wiring	20
3.4.1 Precautions	20
3.4.2 Anti-interference Wiring	22
3.5 Wiring of Motor	24
3.5.1 Connector Terminal Wiring for Motor Encoder	24
3.5.2 Connector Terminal Wiring for Motor Power Supply	24
Chapter IV Panel Operation	25
4.1 Basic Operation	25
4.1.1 Key Names and Functions	25
4.1.2 Selection and Operation of Basic Mode	25

4.1.3	Status Display.....	26
4.2	Auxiliary Function Mode (F□□□□).....	28
4.2.1	Execution Mode List of Auxiliary Functions	28
4.2.2	Display of Software Version of Servo	28
4.2.3	Position Demonstration Operation	29
4.2.4	Identification of Inertia Percentage	29
4.2.5	Confirmation of Motor Model.....	30
4.2.6	Initialization of User Parameter Setup	30
4.2.7	Displaying History Alarm Data.....	31
4.3	Operation under User Parameter Mode (P□□□□).....	31
4.3.1	User Parameter Setting.....	31
4.3.2	Signal Distribution of Input Circuit	33
4.3.3	Signal Distribution of Output Circuit.....	36
4.4	Operation under Monitoring Mode (Un□□□).....	39
4.4.1	List of Monitoring Mode.....	40
Chapter V Operation		43
5.1	Trial Operation	43
5.1.1	Trial Operation for Servo Motor Unit	43
5.1.2	Trial Operation for Servo Motor Unit with Superior Command.....	44
5.1.3	Trial Operation with the servomotor connected to the machine.....	47
5.1.4	Trial Operation of Servomotor with Brakes.....	48
5.1.5	Position Controlled by Command Controller.....	48
5.2	Selection of Control Mode.....	48
5.3	Setting of General Basic Functions	49
5.3.1	Servo ON Setting	49
5.3.2	Rotation Direction Switching of Motor.....	50
5.3.3	Overtravel Setting	50
5.4	Use of Absolute Encoder.....	55
5.4.1	Interface Circuit	56
5.4.2	Selection of Absolute Encoder	57
5.4.3	How to Use Battery	57
5.4.4	Giving and Receiving Sequence of Absolute Data	58
5.4.5	Setting of Absolute Encoder (F□009/ F□010).....	60
5.4.6	Clear of Multi-coil Data of Absolute Encoder	60
5.4.7	Removal of Internal Errors of Bus Encoder.....	61
5.5	Speed Control (Analog Voltage Reference) Operation	61
5.5.1	User Parameter Setting.....	61
5.5.3	Adjustment of Command Offset	62
5.5.4	Soft Start	64
5.5.6	Encoder Signal Output	67
5.6	Position Control Operation	69
5.6.1	User Parameter Setting.....	69
5.6.2	Setting of Electronic Gear	70
5.6.3	Position Reference	72

5.6.4	Smoothing	75
5.6.5	Positioning Completion Signal.....	75
5.6.6	Low-frequency Jitter Suppression.....	76
5.6.7	Inhibition Function of Command Pulse (INHIBIT Function).....	77
5.7	Torque Control Operation	78
5.7.1	User Parameter Setting.....	78
5.7.2	Torque Command Input	78
5.7.3	Adjustment of Offset.....	79
5.7.4	Speed Limit under Torque Control.....	81
5.8	Speed Control (Internal Speed Selection) Operation	82
5.8.1	User Parameter Setting.....	82
5.8.2	Setting of Input Signal	83
5.8.3	Operation at Internal Set Speed.....	83
5.9	Torque Limit	85
5.9.1	Internal Torque Limit (Limitation on Output Torque Maximum Value)	85
5.9.2	External Torque Limit (through Input Signal).....	86
5.9.3	Torque Limit Based on Analog Voltage Command.....	87
5.9.4	Torque Limit Based on External Torque Limit + Analog Voltage Command	88
5.9.5	Confirmation under Input Torque Limit.....	90
5.10	Shift of Control Mode	90
5.10.1	User Parameter Setting.....	90
5.10.2	Shift of Control Mode	90
5.11	Other Output Signal	91
5.11.1	Servo Alarm Output (ALM).....	91
5.11.2	Rotation Detection Output (/TGON).....	91
5.11.3	Servo Ready Output (/S-RDY)	92
5.12	Mode Motion Sequence Manner.....	92
5.12.1	Single Data Set Manner.....	92
5.12.2	Data Set Sequence Manner	94
5.12.3	Operation of Seeking Reference Point (Return to Zero)	99
Chapter VI Communication		103
6.1	Communication Wiring	103
6.2	User Parameter	104
6.3	MODBUS Communication Protocol	105
6.4	MODBUS Communication Address	112
Chapter VII Maintenance and Inspection.....		126
7.1	Abnormality Diagnosis and Treatment Methods	126
7.1.1	Overview of Alarm Display	126
7.1.2	Alarm Displays and Their Causes and Treatment Measures	127
7.1.3	Causes and Treatment Measures of Other Abnormalities	137
7.2	Maintenance and Check of Servo Drive	142
7.2.1	Check of Servo Motor	142
7.2.2	Check of Servo Drive.....	143
7.2.3	General Standards of Replacement of Internal Parts of Servo Drive	143

Appendix A Summary of User Parameters 144

Appendix B Table of iK Series M2 Drive Parameters 176

Appendix C List of Alarm Display 191

Appendix D Guidelines for Motor Model by Users..... 193

 Motor Adaption Table 194

 1: M Series Motor 194

 2. H Series Motor 195

Chapter I Function Overview

1.1 Description of Servo Driver Models

Naming rule of K series servo driver:

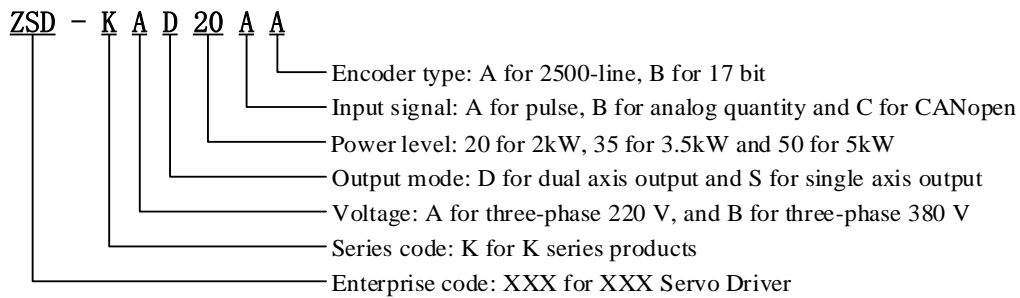

Naming rule of iK series bus servo driver:

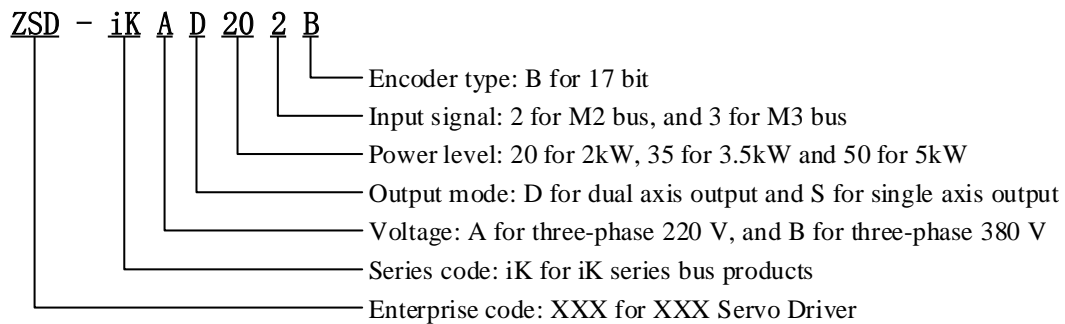

Note: 3.5kW and 5kW products are single axis products

1.2 External Dimension

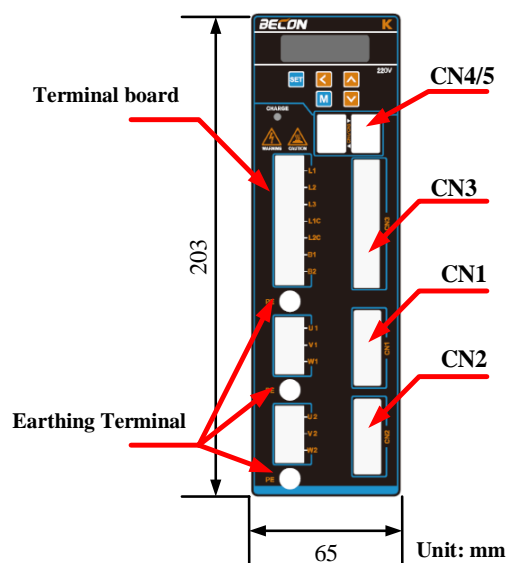

1.3 Basic Functions

Control mode		Position control, JOG running, speed contact, etc.
Encoder feedback		2500-line incremental standard and 17 bit incremental encoders
Use conditions	Ambient/storage temperature	Ambient temperature: 0~+50°C; storage temperature: -20~+85°C
	Ambient/storage humidity	Under 90%RH (no freezing or condensation)
	Vibration/impact resistance strength	4.9m/s ² /19.6m/s ²
Analog speed reference input	Reference voltage	DC±10V
	Input impedance	Appx. 20KΩ
Analog torque reference input	Reference voltage	DC±10V
	Input impedance	Appx. 20KΩ
IO input signal	Point	8 points
	Function (distributable)	Servo ON (/S-ON), P action (/P-CON), positive-side over travel prohibited (P-OT), negative-side over travel prohibited (N-OT), alarm reset (/ALM-RST), positive-side torque limit (/P-CL), negative-side torque limit (/N-CL), position deviation clear (/CLR), internal set speed switch, etc. Distribution of above signals and change of positive/negative logics are available
IO output Signal	Point	6 points
	Function (distributable)	Servo alarm (ALM), position complete (/COIN), velocity compliance detection (/V-CMP), servo motor rotation detection (/TGON), servo ready (/S-RDY), torque limit detection (/CLT), breaker (/BK), encoder zero point output (PGC) Distribution of above signals and change of positive/negative logics are available
Encoder divided frequency output		A-phase, B-phase and C-phase: linear drive output; divided pulse count: can be set freely
RS-485 communication	Communication protocol	MODBUS
	1:N communication	N = 127 stations at maximum
	Axial address setting	Set by parameters
CAN communication	Communication protocol	CANOpen (DS301 + DS402 guild regulations)
	1:N communication	N = 127 stations at maximum
	Axial address setting	Set by parameters
Display functions		CHARGE indicator, 7-segment digital tube 5 bit
Regeneration processing		Built-in or external regeneration resistor (optional)
Overtravel (OT) prevention function		Dynamic breaker (DB) stop, deceleration stop or free running stop during P-OT or N-OT input action
Protection functions		Overcurrent, overvoltage, undervoltage, overload, overspeed, regeneration failure, encoder feedback error, etc.
Monitoring functions		Rotation speed, current position, reference pulse accumulation, positional deviation, motor current, operating status, input and output terminal signal, etc.
Auxiliary functions		Gain adjustment, alarm record, JOG running, origin search, inertia detection, etc.
Intelligent function		Built-in gain auto tuning function
Applicable load inertia		Less than 5 times of the motor inertia
Position control	Feed-forward compensation	0~100% (set unit: 1%)
	Input pulse type	Sign + pulse sequence, CW+CCW pulse sequence, 90 ° phase difference two-phase pulse (A phase + B phase)
	Input pulse type	Linear drive and open connector supported
	Maximum input pulse frequency	Linear drive: Sign + pulse sequence, CW+CCW pulse sequence: 500Kpps 90 ° phase difference two-phase pulse (A phase + B phase): 500Kpps Open connector: Sign + pulse sequence, CW+CCW pulse sequence: 200Kpps 90 ° phase difference two-phase pulse (A phase + B phase): 200Kpps

Chapter II Installation and Dimension

2.1 Servo Driver

K series servo drivers are base-mounted and improper installation may give rise to failures. Please install the servo driver properly by following the instructions below.

2.1.1 Storage Condition

The servo driver should be kept in a place with an ambient temperature of $[-20\sim+85]^{\circ}\text{C}$ when not used.

2.1.2 Installation Site

- Temperature: $0\sim55^{\circ}\text{C}$;
- Ambient humidity: not higher than 90% RH (no condensation);
- Sea level not higher than 1000 m;
- Maximum vibration: 4.9m/s^2 ;
- Maximum Impact: 19.6m/s^2 ;
- Other installation precautions:

·Installed in a control cabinet

Attention should be paid to the size of the control cabinet, the placement mode of servo driver and cooling mode, in order to ensure that the ambient temperature for the servo driver is under 55°C . Please refer to description in Section 1.2.2 for operation details;

·Installed near heat source

The radiation of the heat source and temperature rise caused by convection should be under control, in order to ensure that the ambient temperature for the servo driver is under 55°C ;

Installed near vibration source

A vibration isolation device should be installed to avoid vibration passing to the servo driver;

·Installed in a place exposed to corrosive air

Necessary measures should be taken to prevent the servo driver from exposing to corrosive air. Corrosive air may not immediately affect servo driver but will obviously cause the failure of electronic components and relevant elements of the contactor;

·Other occasions

Servo driver should not be put in occasions of high temperature, high humidity, condensation dripping, oil splashing, dust, scrap iron or radiation;

Note: when cutting off the power to store the servo driver, please put the driver in a place with the following environmental conditions: $-20\sim85^{\circ}\text{C}$, 90% RH below (no condensation)

2.1.3 Installation Direction

The direction of installation should be vertical to the mounting surface and two mounting holes should be used to reliably fix the servo driver on the installation base. If required, a fan should be installed to compulsorily cool the servo driver.

2.1.4 Installation of Several Servo Drivers

If more than one servo driver should be installed in a control cabinet in parallel, the space indicated below should be followed for installation and heat dissipation.

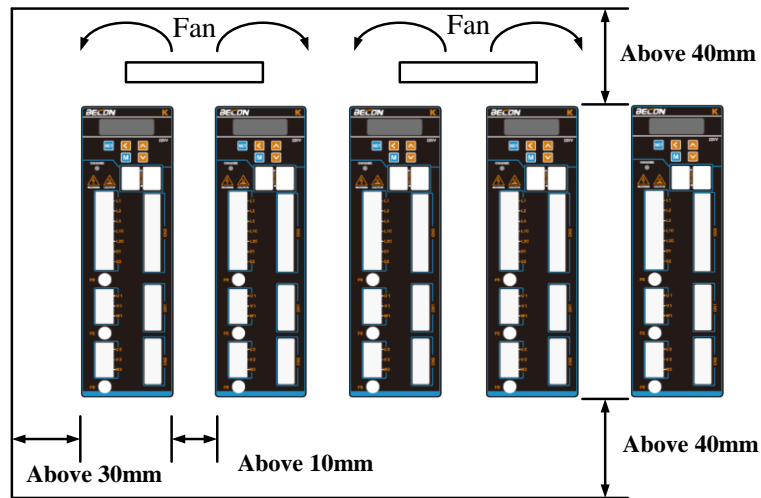

■ Installation direction of servo driver

The front (wiring side) of the servo driver should face the operator and should be vertical to the mounting base.

■ Cooling

Adequate space should be reserved around the servo driver to ensure cooling through a fan or free convection.

■ Parallel installation

As shown above, a space of above 10 mm should be reserved at both sides of the horizontal direction and a space of above 50mm should be reserved at both sides of the vertical direction. The temperature inside the control cabinet should be kept even to avoid excess temperature in some parts of the servo driver. If necessary, a fan for compulsory cooling and convection should be installed above the servo driver.

■ Environmental condition for normal operation of servo driver

1. Temperature: 0~ 55°C
2. Humidity: below 90%RH (no condensation)
3. Vibration: below 4.9m/s²
4. To ensure long-term stable use, it is recommended to use the servo driver under an environmental temperature condition of 45°C and below.

2.1.5 Dimension Description

Dimension of 1.5kW / 2.0kW (220V) and 2.0kW / 3.5kW (380V) are shown below:

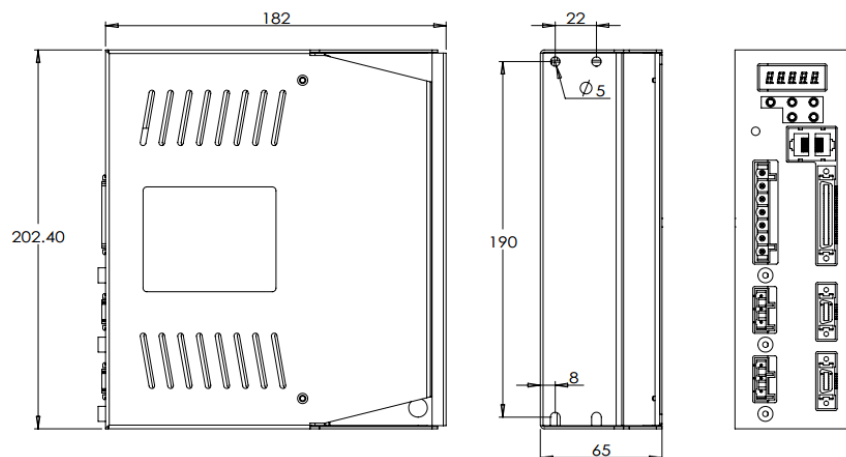

Dimension of 3.5kW / 5.0kW (220V) and 5.0kW / 7.5kW (380V) are shown below:

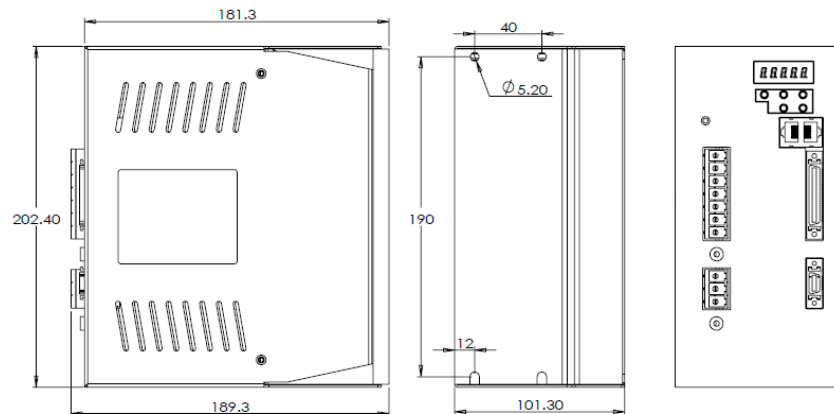

2.2 Servo Motor

The servo motor can be installed in horizontal or vertical direction. The service life of the servo motor will be shortened significantly or unexpected accident may occur if any mechanical mismatch occurs during installation. Please follow the instructions below for correct installation.

Precautions before installation:

Antirust agent is applied at the motor axis end and should be wiped off using a soft cloth dipped in diluent before installation.

When wiping off the antirust agent, attention should be paid to prevent the diluent from contacting other parts of the servo motor.

2.2.1 Storage Temperature

The servo motor should be kept in a place with an ambient temperature of $[-20\sim+60]^{\circ}\text{C}$ when not used.

2.2.2 Direction

Servo motor should be installed indoor and the indoor space should meet the following environmental conditions.

- No corrosive, flammable or explosive air
- Good ventilation, little dust and dry environment
- Ambient temperature within 0~40°C
- Relative humidity within 26%~80%RH without condensation
- Easy for maintenance and cleaning

2.2.3 Installation Concentricity

Flexible coupling should be used as much as possible when connecting to machinery. In addition, axis of servo motor should be placed in a straight line with that of mechanical load. When installing servo motor, requirements for concentricity tolerance should be met as the following figure.

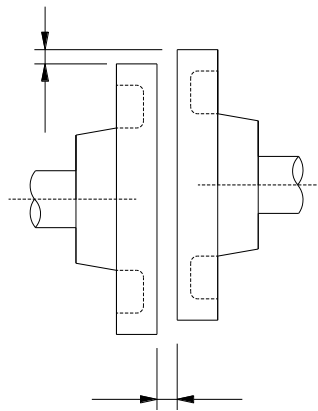

Measure at quarter of a circle to make sure that difference between max. value and min. value is lower than 0.03 mm. (rotating with coupling)

-
- **Mechanical vibration will be caused by large concentricity deviation and therefore will lead to damages to servo motor bearing.**
 - **When installing coupling, axial percussion is prohibited, otherwise damages will be caused to encoder of servo motor.**
-

2.2.4 Installation Direction

Servo motors can be installed horizontally, vertically or in random direction.

2.2.5 Protection Measures Against Water and Oil

When using in places containing water, oil or condensation, it is required to take special measures to motors as per protection requirements; however, motors with oil seals should be used since protection requirements for shaft penetrating portion should be satisfied when motors leaving factory. Shaft penetrating portion refers to interval between extension of motor end and end flange.

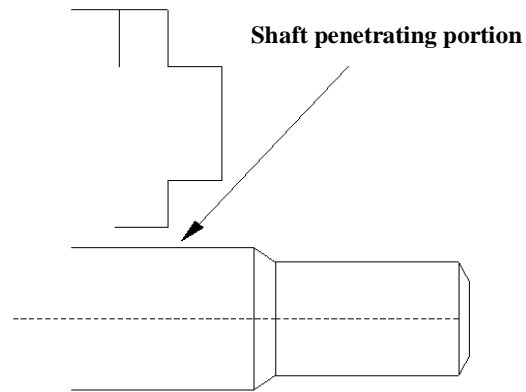

2.2.6 Cable Tension

Bending radius cannot be too small when connecting cables. It is also not suggested to exert too much tension in cables. Specially, diameter for core wire of signal line is usually very fine (0.2 or 0.3 mm), therefore too much tension cannot be exerted during wiring.

Chapter III Wiring

3.1 Wiring of Main Circuit

This section explains wiring examples of main circuit, functions of terminals in main circuit and power ON sequence.



Notes

- **Do not lead power lines and signal lines to the same pipe, nor bind them together. During wiring, power lines should be kept over 30 cm away from signal line.**
Otherwise, malfunction may be caused.
- **Multi-stranded wires and multi-core shielded wire should be used as signal lines and feedback wires for encoder (PG).**
As for wire length, reference input wire should be 3m at most and 20 m at most for PG feedback wire.
- **High voltage may be maintained in the servo driver even the power is turned off. Do not touch power terminal within 5 minutes after power off.**
Inspection operation should be carried out when CHARGE indicator light is confirmed to be off.
- **Do not frequently turn on or off the power. If it is required to continuously turn on or off the power, frequency should be limited to 1 time/min below.**
Due to capacitance in power of servo unit, large charging current (charging for 0.2 s) will flow through when power is ON. Therefore, performance of components in main circuit within servo unit will be damaged if power is turned on/off frequently.

3.1.1 Descriptions of Terminals

Terminals and respective function and precaution for driver panel are as follows.

Terminal	Functions	Precautions for operation
U1, V1, W1	Terminal of A-axis motor power line	Connected to A-axis servo motor
U2, V2, W2	Terminal of b-axis motor power line	Connected to b-axis servo motor
L1, L2, L3	Input terminal of main circuit power	Three phase 200 - 230VAC (-15%~+10%) (50/60Hz)
L1C, L2C	Power input terminal of control loop	Single phase 200 - 230VAC (-15%~+10%) (50/60Hz)
B1, B2	Terminal of bleeder resistor	Resistor should be connected to B1 and B2 if external connection for bleeder resistor is required
PE	Earthing Terminal	Earthing measures should be carried out for connection of power earthing terminals and motor earthing terminals

Notes: A axis refers to U1, V1 and W1; b axis refers to U2, V2 and W2 in the instruction.

3.1.2 Typical Examples for Main Circuit Wiring

■ Three phase 220 V (double-axis drive)

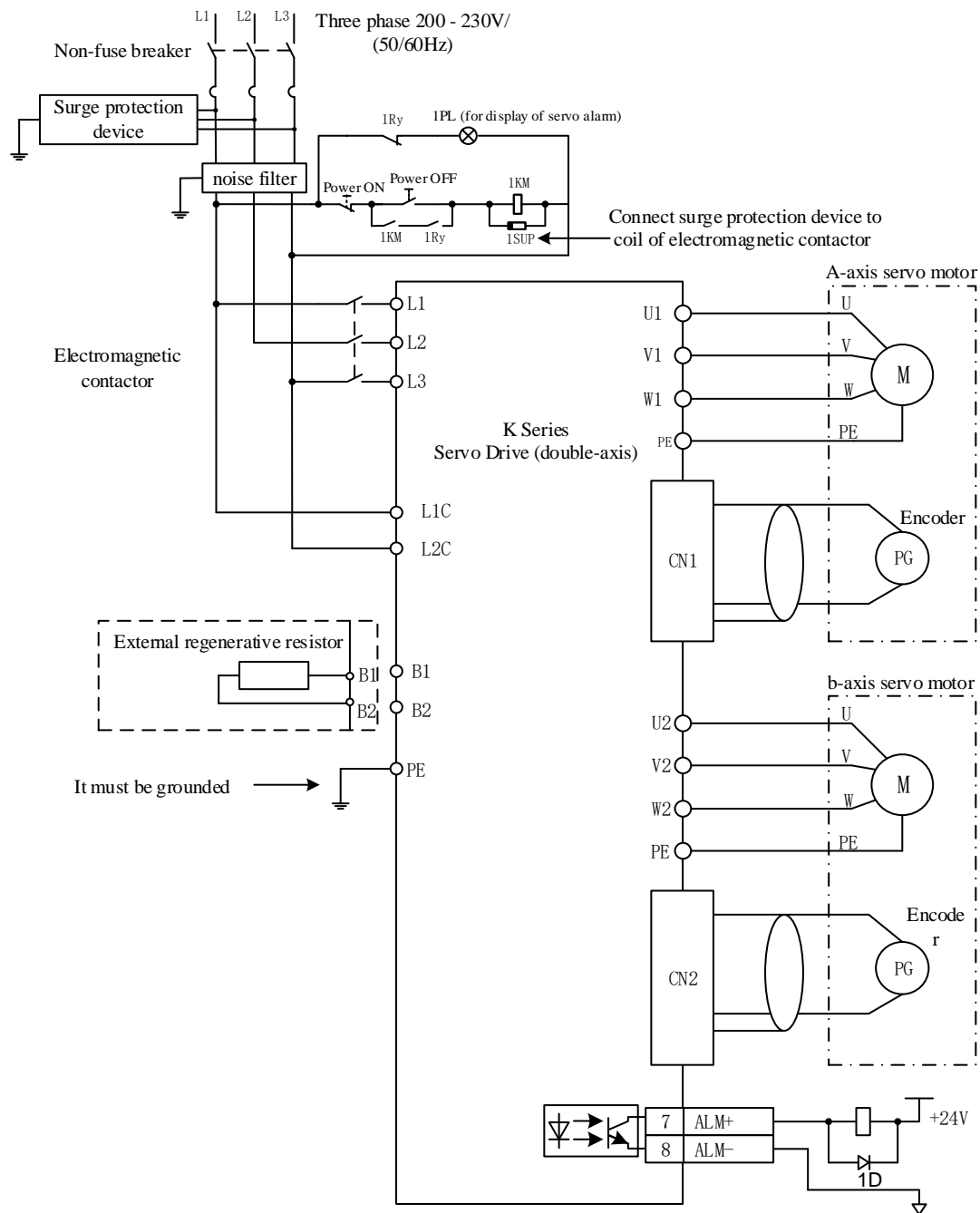

■ Three phase 220 V (single-axis drive)

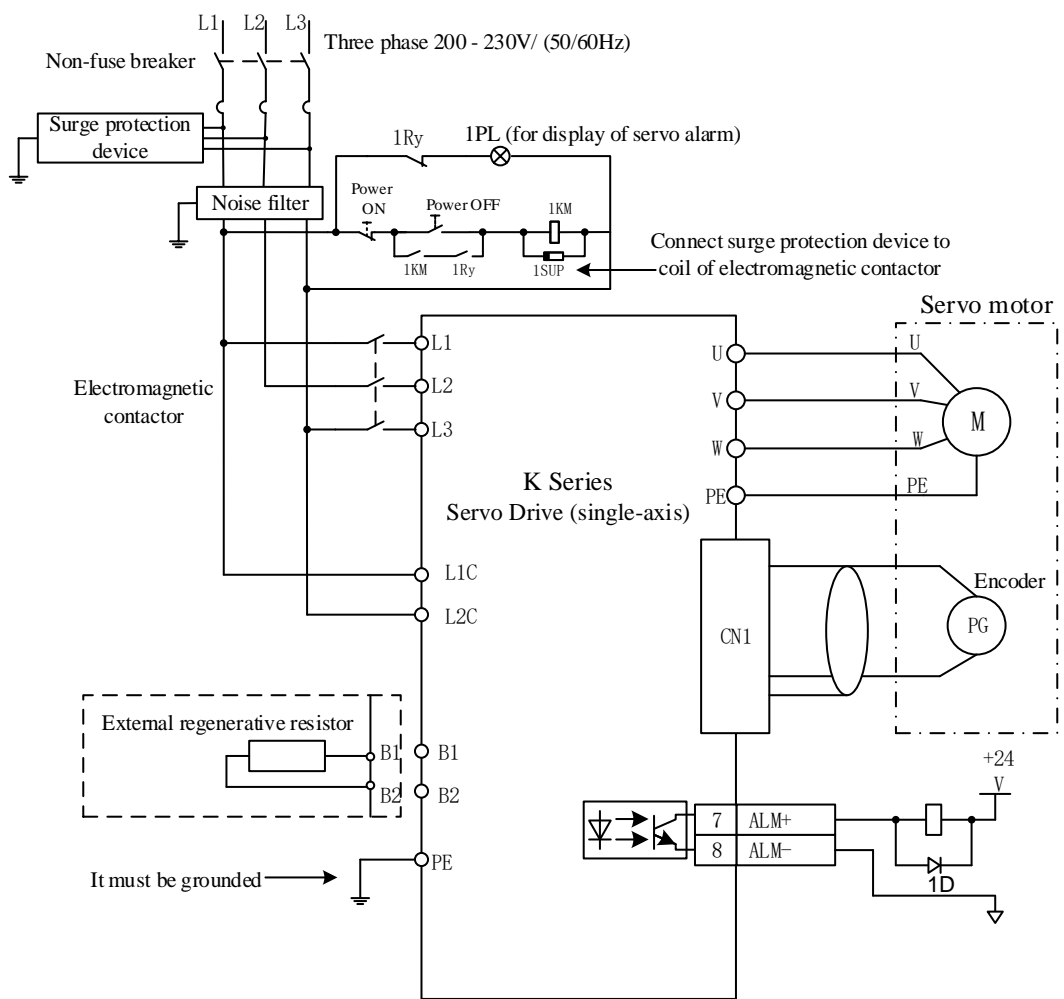

Notes: design of power ON sequence

The following items should be considered during design of power ON sequence.

1. Design of power ON sequence: power should be OFF after output of signals of "servo alarm". (Refer to the above circuit diagram.)
2. Press the POWER ON button for over 2 s. When control power of servo unit is ON, output 2s "servo alarm" signal (1Ry: OFF). It is required to be done during initial setting of servo driver.

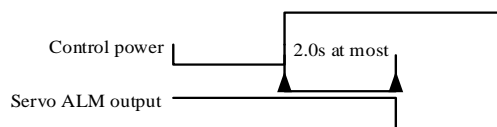

3. Power specification for used parts should match with input power.

■ Three phase 380 V (single-axis drive)

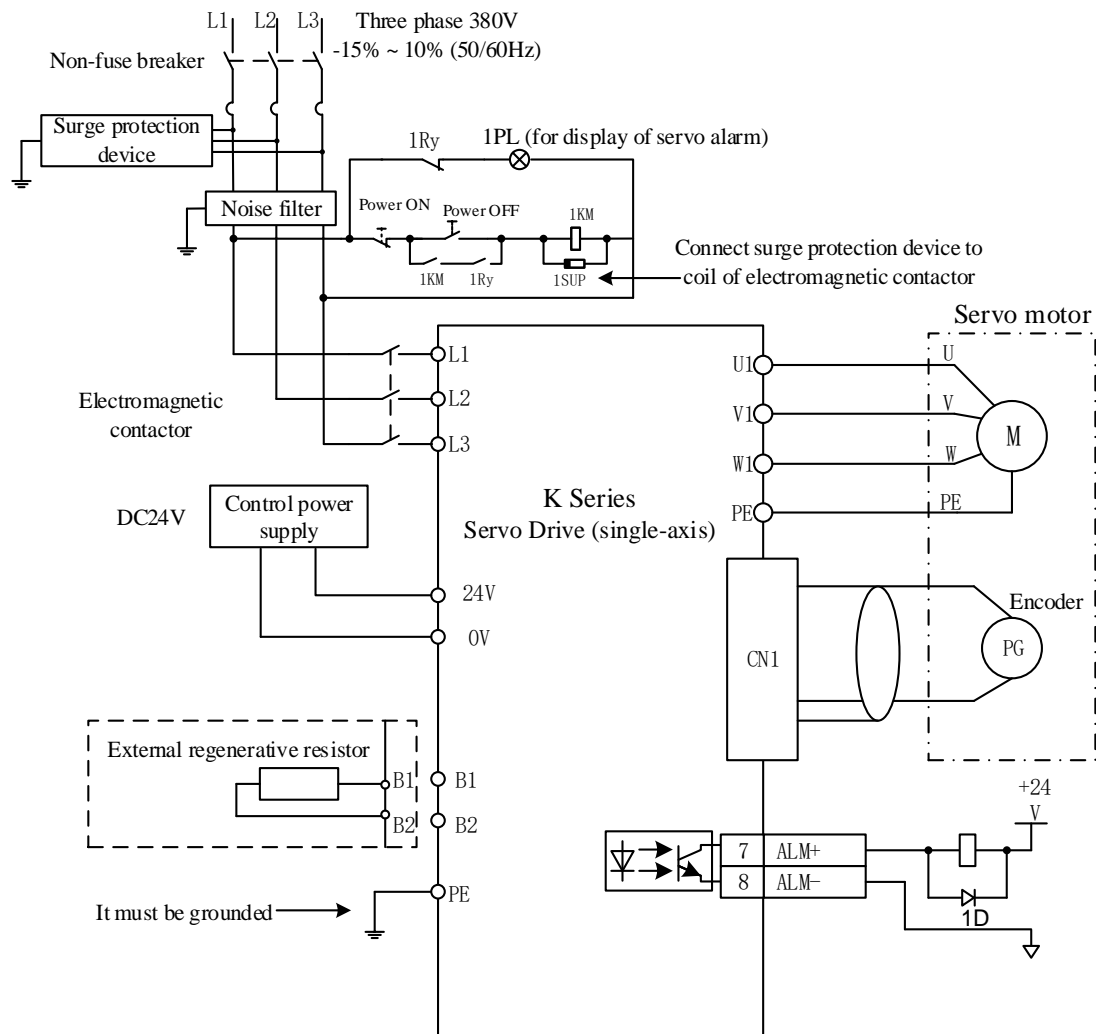

3.2 Encoder Signal Wiring

Connecting cables between encoder and servo driver and their wiring pin No. vary with servo motors. Signal of side encoder interface (CN1/CN2) for servo driver:

Terminal No.	Signal leads		Terminal No.	Signal leads	
	Incremental encoder	Bus encoder		Incremental encoder	Bus encoder
1	PA	—	8	PU	—
2	/PA	—	9	/PU	—
3	PB	—	10	PV	—
4	/PB	—	11	/PV	—
5	PC	E+	12	PW	SD+
6	/PC	E-	13	/PW	SD-
7	5V	5V	14	GND	GND
Casing	Shielded wire				

3.2.1 Connection with Encoder Interface (CN1/CN2) and Processing of Output Signal from CN3

In the figure: *1: connector wiring pin No. varies with used servo motor.

*2: refers to multi-stranded shielded wire.

*3: connector wiring pin No. varies with used servo motor. 19 -25 is pin number for axis A of single-axis or double axis motor; 44 - 49 is pin number of axis b of double-axis motor.

(1) 2500 incremental wire-saving encoder

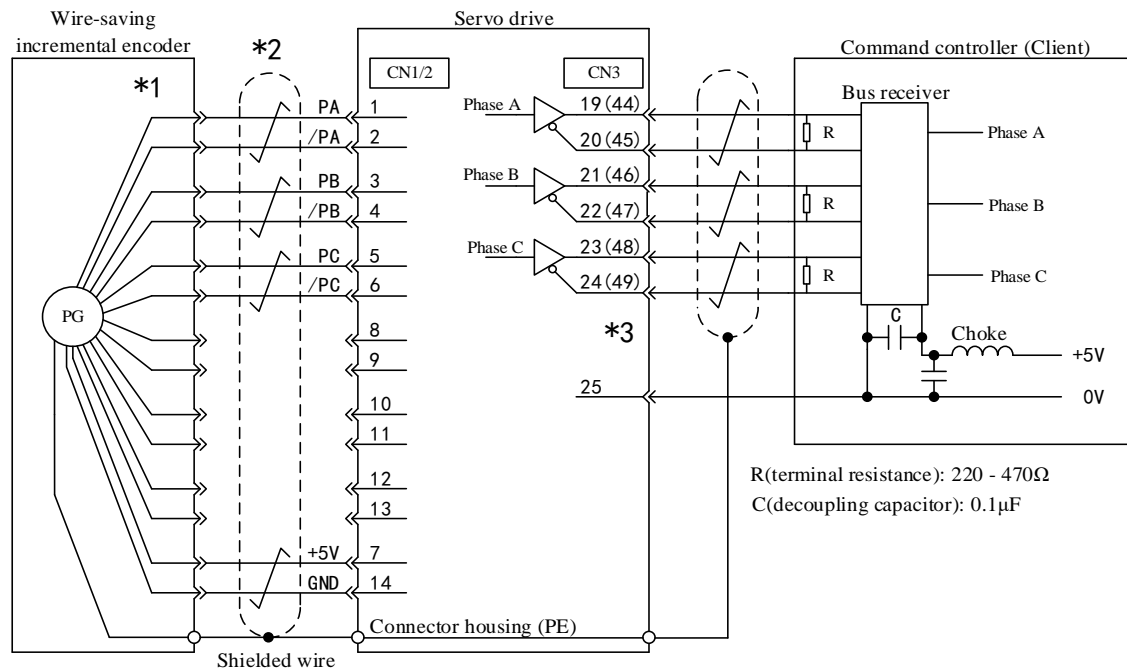

(2) 2500 incremental standard encoder

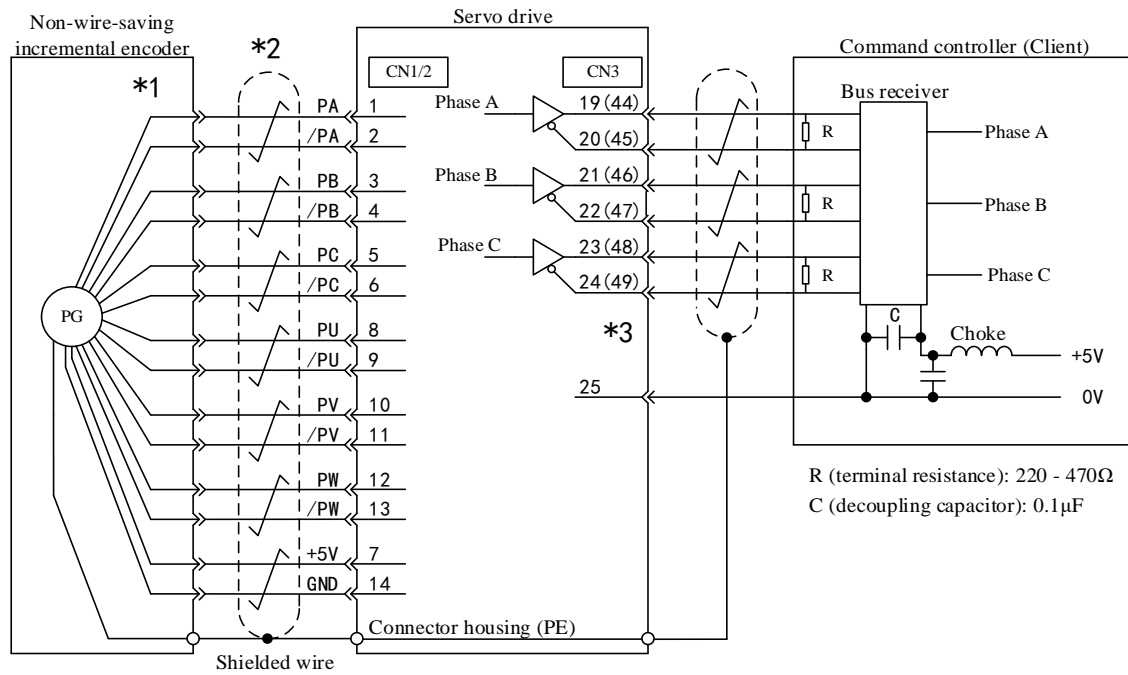

(3) Bus incremental encoder

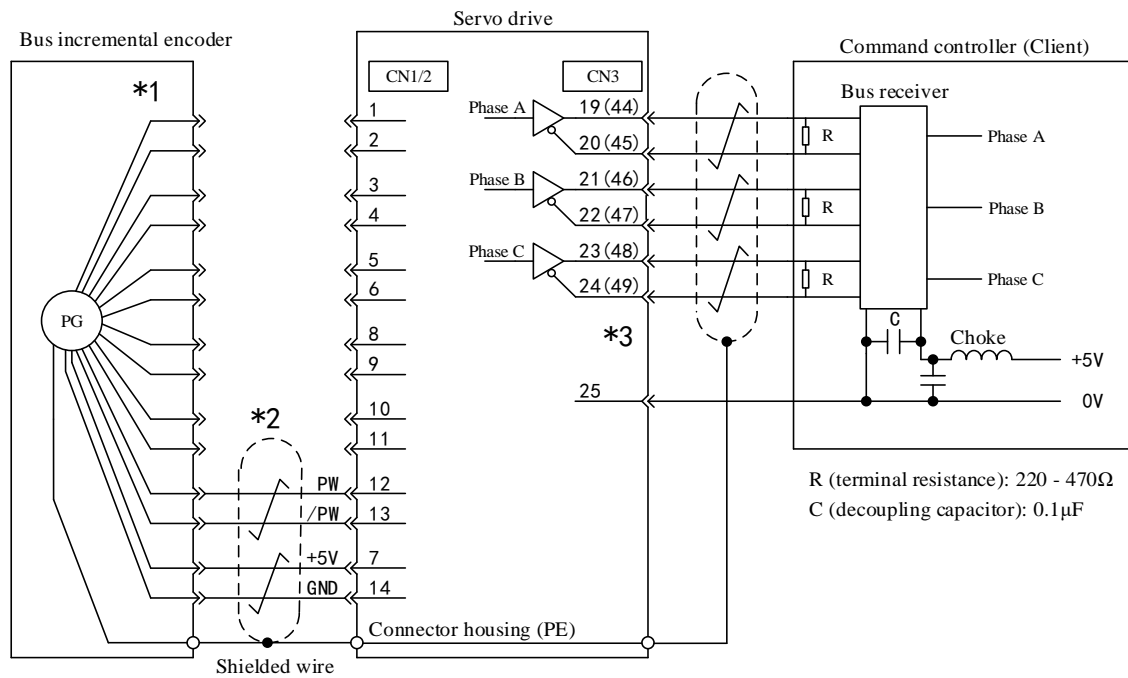

(4) Bus absolute encoder

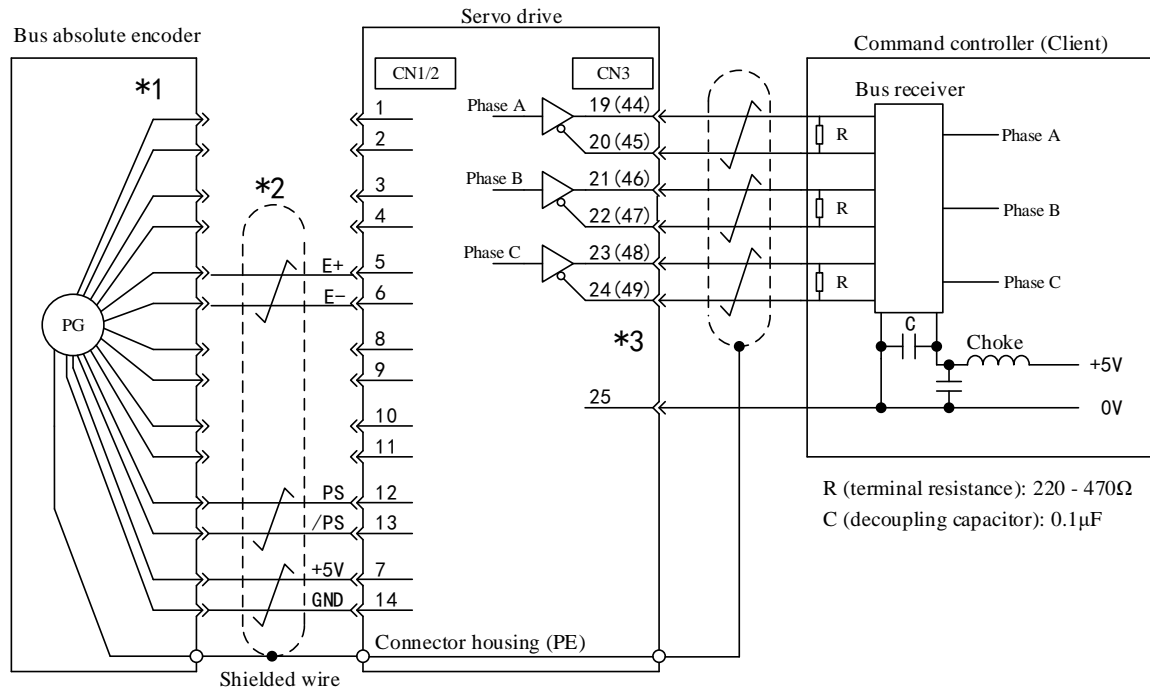

3.3 Input/Output Signal Wiring

3.3.1 Speed/Torque Control Mode

Pin-out for signal wiring of single-axis driver should be subject to A-axis wiring pin-out. The b-axis pin-out will not be connected.

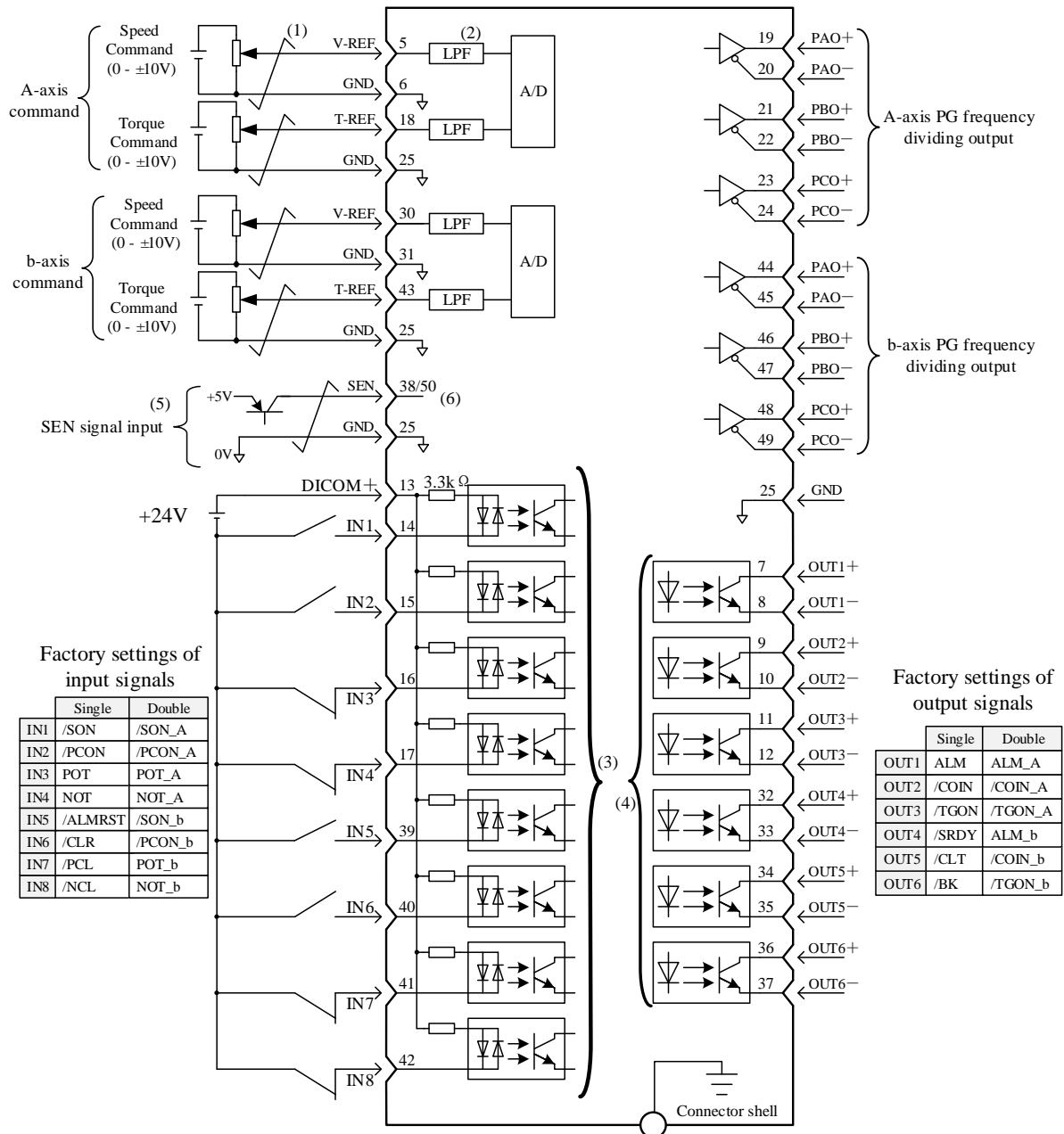

- (1) Refers to shielded twisted pair cable
- (2) Time parameter is 47 us for first filtering
- (3) Distribution change can be done by user parameter (P□509 - P□512) when inputting IN1 - IN8 signals
- (4) Distribution change can be done by user parameter (P□513 - P□514) when outputting OUT1 - OUT6 signals
- (5) With absolute encoder, connect to it when serial output is required for absolute data via PAO (P□001.0 = 0)
- (6) CN3-38 is A-axis SEN input and CN3-50 is b-axis SEN input

3.3.2 Position Control Mode

Pin-out for signal wiring of single-axis driver should be subject to A-axis wiring pin-out. The b-axis pin-out will not be connected.

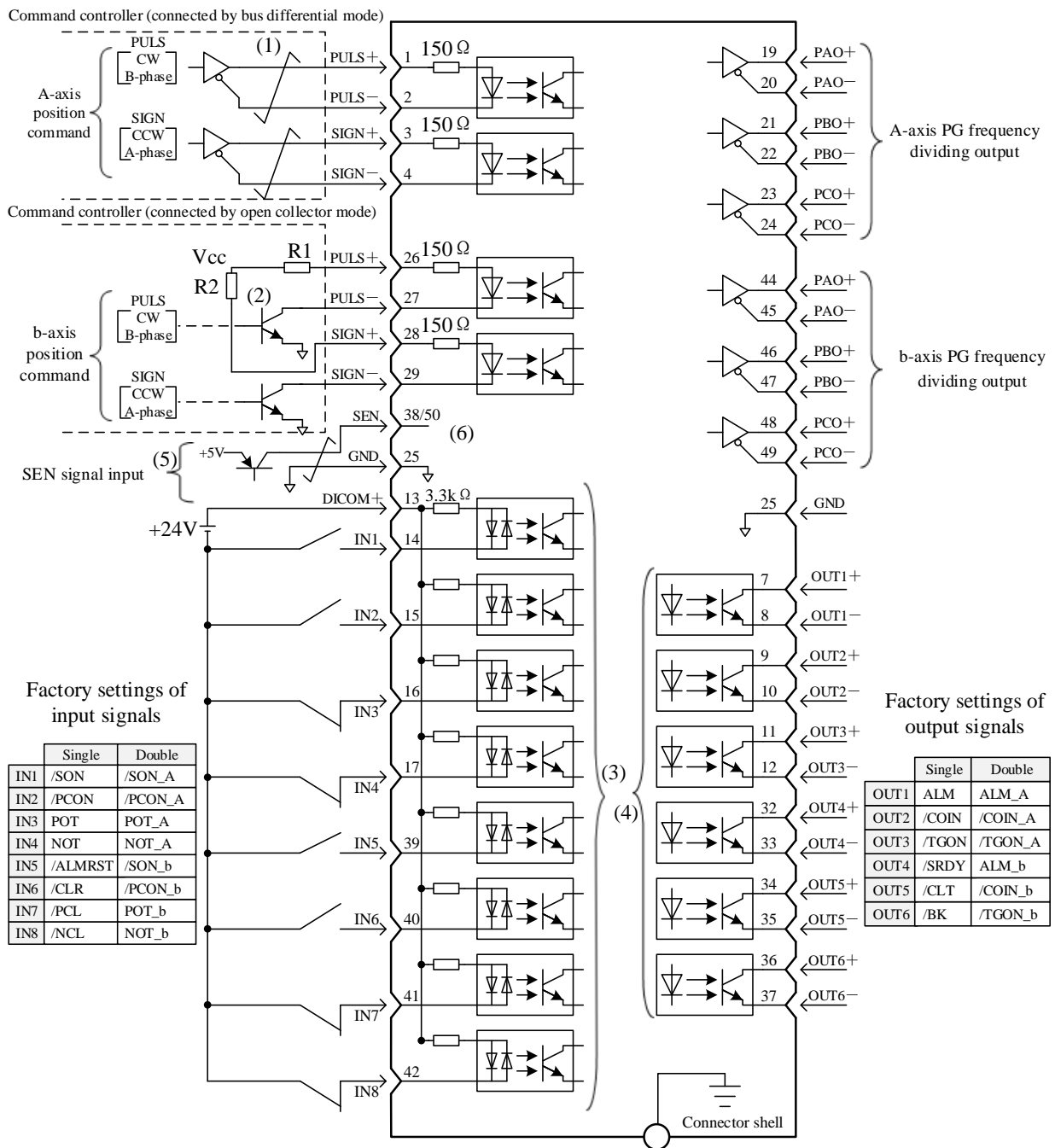

- (1) Refers to shielded twisted pair cable
- (2) When open collector is used as the input mode for position command pulse, external resistor should be connected:
 $V_{cc}=24V$ 时, $R1=R2=2.2K\Omega$
 $V_{cc}=12V$ 时, $R1=R2=1K\Omega$
 $V_{cc}=5V$ 时, $R1=R2=180\Omega$
- (3) Distribution change can be done by user parameter (P□509 - P□512) when inputting IN1 - IN8 signals
- (4) Distribution change can be done by user parameter (P□513 - P□514) when outputting OUT1 - OUT6 signals
- (5) With absolute encoder, connect to it when serial output is required for absolute data via PAO (P□001.0 = 0)
- (6) CN3-38 is A-axis SEN input and CN3-50 is b-axis SEN input

3.3.3 Signals and Their Functions for Input/Output Connector (CN3)

Terminal No.	Name	Functions		Terminal No.	Name	Functions	
		Single-axis driver	Double-axis driver			Single-axis driver	Double-axis driver
1	APULS+	Reference pulse input	A-axis reference pulse input	26	BPULS+	Reserved	b-axis reference pulse input
2	APULS-			27	BPULS-		
3	ASIGN+	Reference sign input	A-axis reference sign input	28	BSIGN+	Reserved	b-axis reference sign input
4	ASIGN-			29	BSIGN-		
5	AV-REF	Speed reference input	A-axis speed reference input	30	BV-REF	Reserved	b-axis speed reference input
6	GND	Signal ground	Signal ground	31	GND	Signal ground	Signal ground
7	OUT1+	Output port 1, which can be reallocated (Factory setting:ALM)	Output port 1, which can be reallocated (Factory setting:A-axis ALM)	32	OUT4+	Output port 4, which can be reallocated (Factory setting:/S-RDY)	Output port 4, which can be reallocated (Factory setting: b-axis ALM)
8	OUT1-			33	OUT4-		
9	OUT2+	Output port 2, which can be reallocated (Factory setting:/COIN)	Output port 2, which can be reallocated (Factory setting:A-axis/COIN)	34	OUT5+	Output port 5, which can be reallocated (Factory setting:/CLT)	Output port 5, which can be reallocated (Factory setting: b-axis/COIN)
10	OUT2-			35	OUT5-		
11	OUT3+	Output port 3, which can be reallocated (Factory setting:/TGON)	Output port 3, which can be reallocated (Factory setting:A-axis/TGON)	36	OUT6+	Output port 6, which can be reallocated (Factory setting:/BK)	Output port 6, which can be reallocated (Factory setting: b-axis/TGON)
12	OUT3-			37	OUT6-		
13	DICOM	Common port of input signal	Common port of input signal	38	SEN	SEN signal input	A-axis SEN signal input
14	IN1	Input port 1, which can be reallocated (Factory setting:/S-ON)	Input port 1, which can be reallocated (Factory setting:A-axis/S-ON)	39	IN5	Input port 5, which can be reallocated (Factory setting:/ALM-RST)	Input port 5, which can be reallocated (Factory setting: b-axis/S-ON)
15	IN2	Input port 2, which can be reallocated (Factory setting:/P-CON)	Input port 2, which can be reallocated (Factory setting:A-axis/P-CON)	40	IN6	Input port 6, which can be reallocated (Factory setting:/CLR)	Input port 6, which can be reallocated (Factory setting: b-axis/P-CON)
16	IN3	Input port 3, which can be reallocated (Factory setting: POT)	Input port 3, which can be reallocated (Factory setting:A-axis POT)	41	IN7	Input port 7, which can be reallocated (Factory setting: /PCL)	Input port 7, which can be reallocated (Factory setting: b-axis POT)
17	IN4	Input port 4, which can be reallocated (Factory setting: NOT)	Input port 4, which can be reallocated (Factory setting:A-axis NOT)	42	IN8	Input port 8, which can be reallocated (Factory setting:/NCL)	Input port 8, which can be reallocated (Factory setting: b-axis NOT)
18	AT-REF	Torque reference input	A-axis torque reference input	43	BT-REF	Reserved	b-axis torque reference input
19	APAO+	Phase A of PG frequency dividing output	Phase A of A-axis PG frequency dividing output	44	BPAO+	Reserved	Phase A of b-axis PG frequency dividing output
20	APAO-			45	BPAO-		
21	APBO+	Phase B of PG frequency dividing output	Phase B of A-axis PG frequency dividing output	46	BPBO+	Reserved	Phase B of b-axis PG frequency dividing output
22	APBO-			47	BPBO-		
23	APCO+	Phase C of PG frequency dividing output	Phase C of A-axis PG frequency dividing output	48	BPCO+	Reserved	Phase C of b-axis PG frequency dividing output
24	APCO-			49	BPCO-		
25	GND	Signal ground	Signal ground	50	BSEN	Reserved	b-axis SEN signal input

Note:

1. Do not use any idle terminal.
2. Connect the shielded wires for input/output signal cables to connector shells.
3. The following input/output signals can change function distribution by setting user parameters

Output: OUT1, OUT2, OUT3, OUT4, OUT5, OUT6

The said output ports can change into ALM, /COIN, /TGON, /S-RDY, /CLT, /BK, /PGC of A axis or B axis

Input: IN1, IN2, IN3, IN4, IN5, IN6, IN7, IN8

By parameters, the said input ports can change into such signals of A axis or B axis as /S-ON, /P-CON, POT, NOT, /ALM-RST, /CLR, /PCL, /NCL and /GSEL

3.3.4 Interface Circuit

Examples of connection of input/output signal of servo unit and its command controller are shown as below.

(1) Interfaces to reference input circuit

(a) Analog input circuit

The following is to describe 5-6 (speed reference input) terminals and 18-25 (torque reference input) terminals of CN3 connector.

Analog signal is the signal of speed reference or torque reference. Input impedance is shown as below.

·Speed reference input: appx. 20 KΩ

·Torque reference input: appx. 20 KΩ

Maximum allowable voltage of input signal is 12 V.

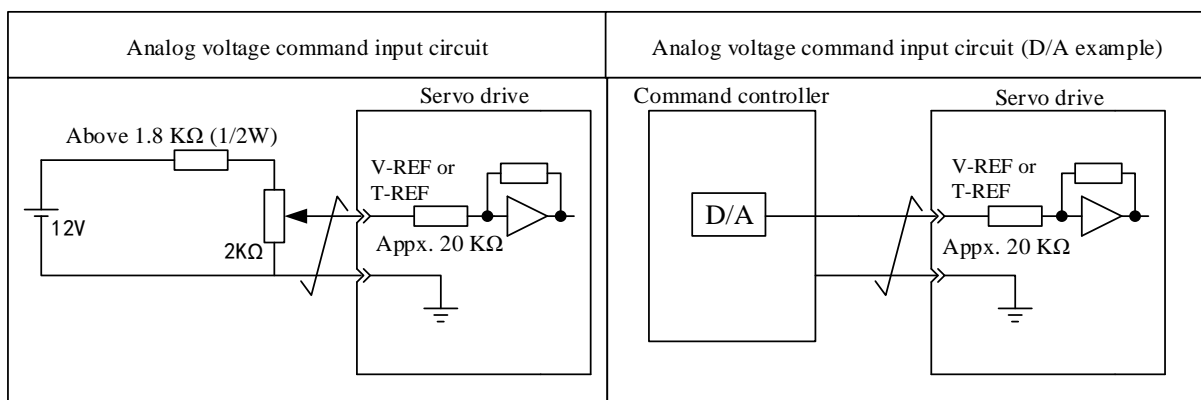

(b) Position reference Input Circuit

The following is to describe 1-2 (reference pulse input) terminal and 3-4 (reference sign input) terminal of CN3 connector.

Reference pulse output circuit at the side of command controller can be optional between bus driver output and open-collector output, as classified as below.

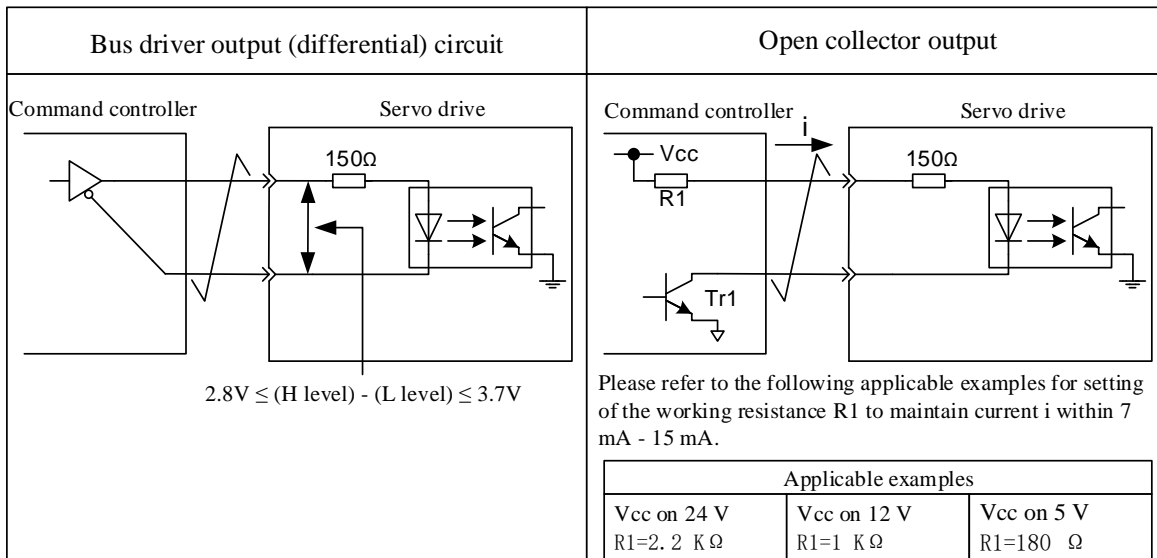

(2) Interfaces to sequence control input circuit

The following is to describe IN1 - IN8 terminals of CN3 connector.

Connect through the transistor circuit of relay or open connector. Please select relay for small current when using relay for connection. If otherwise, bad contact will occur.

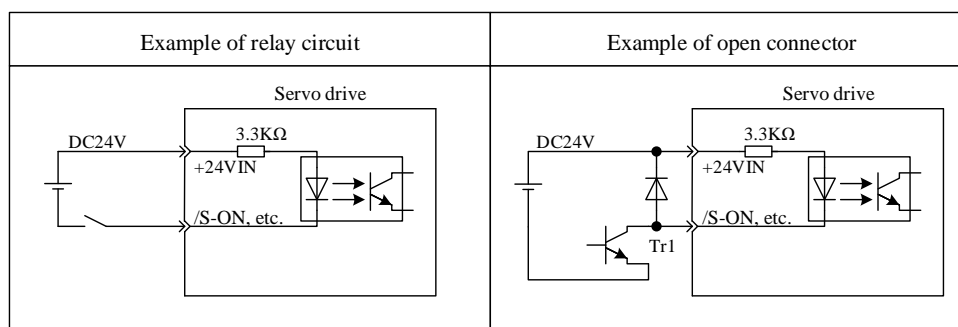

Note: For interface of SEN signal input circuit, please refer to Chapter "Usage of Absolute Value Encoder".

(3) Absorption circuit and release circuit

Use two-way photocoupler as input circuit of servo driver. Please select absorption circuit connection and release circuit connection according to the specification required for the machine.

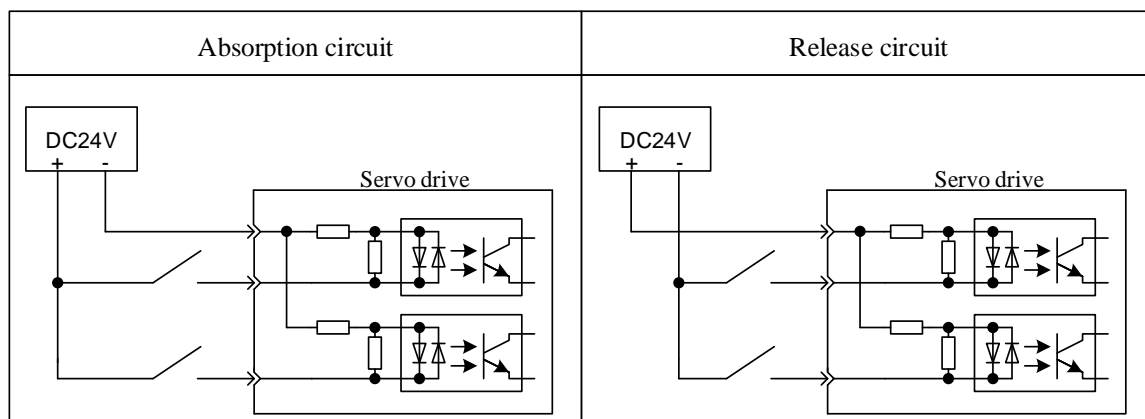

(4) Interfaces to output circuit

(a) Bus driver (differential) output circuit

The following is to describe 19-20 (A phase signal) terminals, 21-22 (B phase signal) terminals and 23-24 (C phase signal) terminals of CN3 connector.

Output signal (PAO/PAO, PBO/PBO), origin pulse signal (PCO/PCO) and S phase rotation quantity signal (PSO/PSO) that convert the 2 phases (A, B) of serial data for encoder are outputted by bus driver output circuit, which is generally used when servo unit forms position control system at the side of command controller through speed control. At the side of command controller, please use bus receiver circuit to receive.

(b) Photocoupler output circuit

Servo alarm (ALM), servo ready (/S - RDY) and other sequence signals are constituted by photocoupler output circuit and are connected through relay circuit or bus receiver circuit.

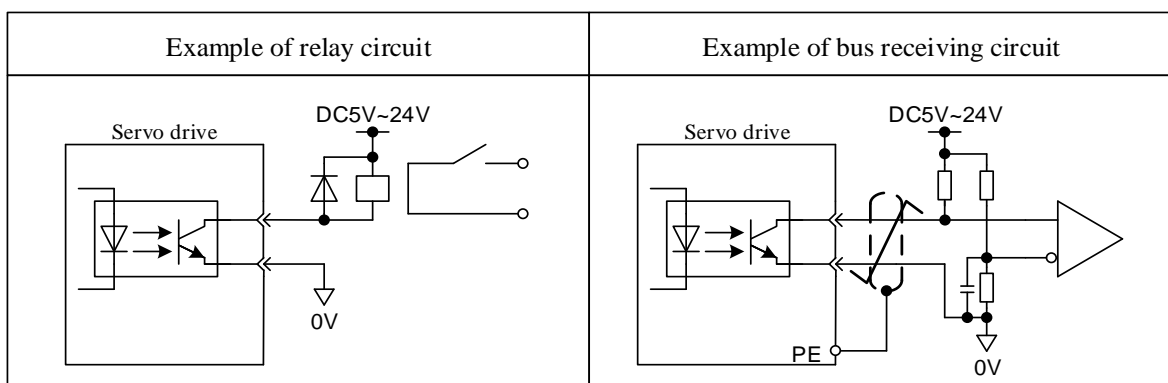

Note: maximum allowable voltage and current capacity of photocoupler output circuit are shown as below.

- Maximum voltage: DC 30 V
- Maximum current: DC 50 mA

3.4 Other wiring

3.4.1 Precautions

1. For reference input and wiring leading to encoder, please use the specified cable. Please select the cable with shortest connection distance.
2. Use heavy wire (above 2.0 mm²) whenever possible as grounding wire.
 - Grounding superior to D type (with grounding resistance of below 100 Ω) is recommended.
 - It must be one-point grounding.
 - Please directly ground the servo motor when servo motor and machine are insulated from each other.
3. Do not blend or impose tension on the wire.

Core wire thickness of cable for signal is only 0.2 mm or 0.3 mm, so be careful when using it.
4. For radio frequency interference, please use noise filter.
 - When it is used around residences or radio frequency interference is concerned, please insert noise filter at the input side of power wire.

·Since servo unit is industrial equipment, no countermeasure is taken against radio frequency interference.

To prevent misoperation due to noise, the following approaches are effective.

·Please locate reference input equipment and noise filter close to servo unit where possible.

·Please be sure to install surge suppressor on the coils of relay, solenoid and electromagnetic contactor.

·Please separate power wire (high voltage circuit of power wire, servo motor wiring, etc.) and signal wire while wiring, with the interval kept above 30 cm. Do not put them into the same pipeline or bind them.

·Do not use the same power as electric welding machine, electrical discharge machine, etc. Even if so, please insert noise filter at the input side of power wire when there is high frequency generator around.

6. Use molded case circuit breaker (QF) or fuse to protect power wire.

·The servo driver is directly connected to industrial power wire. To protect servo system from cross electric shock accident, please be sure to use molded case circuit breaker (QF) or fuse.

7. There is no built-in grounding protection circuit in servo driver. To form a safer system, please configure residual-current circuit breaker for both overload and circuit protection, or residual-current circuit breaker with supporting molded case circuit breaker for special protection of ground wire.

3.4.2 Anti-interference Wiring

(1) Example of anti-interference wiring

"High speed switch element" is used for the main circuit of this servo driver, which may be subject to the influence of switch and noise because of switch element depending on the peripheral wiring and grounding processing of servo driver. Therefore, proper grounding and wiring process are necessary.

Microprocessor (CPU) is built in the servo driver, so "noise filter" is required to be configured in place to prevent as much external interference as possible.

(2) Proper grounding processing

(a) Grounding of motor framework

Please be sure to connect the motor frame terminal "FG" of servo motor to the grounding terminal "PE" of servo unit. In addition, grounding terminal "PE" must be grounded.

When servo motor is grounded via a machine, switch interference current will flow from the power part of servo unit through the stray capacitance of servo motor.

The above are precautions for such influence.

(b) When there is interference on reference input wire

When there is interference on reference input wire, please ground the OV wire (GND) of the input wire. When passing the main circuit wiring of motor through a metal conduit, please ground the conduit and its junction box.

Please conduct one-point grounding for the above grounding processing.

(3) Usage of noise filter

Use blocking noise filter to prevent interference from power wire. Besides, insert noise filter for power wire of peripheral devices as required.

■ Noise filter for brake power

When using servo motor (below 400 W) with holding brake, please use the following noise filter at the power input of brake.

Model: FN2070-6/07 (manufactured by SCHAFFNER)

■ Precautions for operation of noise filter

When installing and wiring noise filter, please follow the following precautions. In case of misoperation, noise filter will be greatly less effective.

1. Please separate input wiring from output wiring and do not put them into the same pipeline or bind them together.

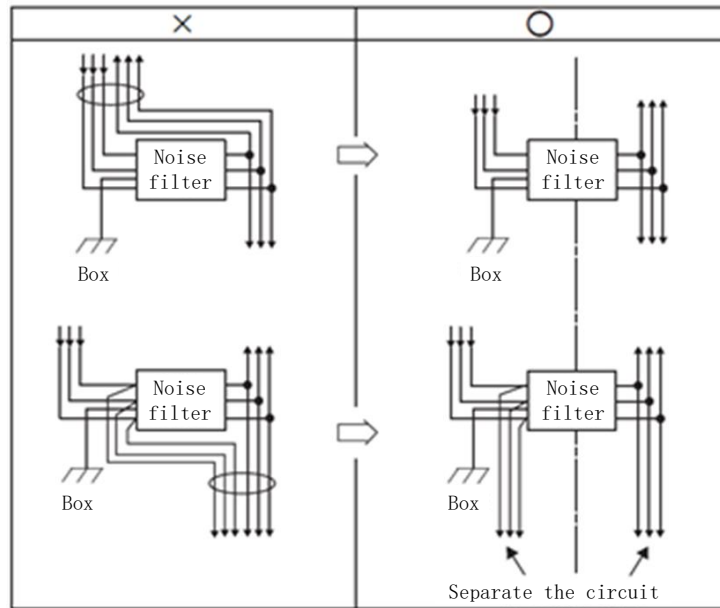

2. Separate the grounding wire of noise filter from its output wiring.

Please do not put the output wiring of noise filter and other signal wires and grounding wires into the same pipeline or bind them together.

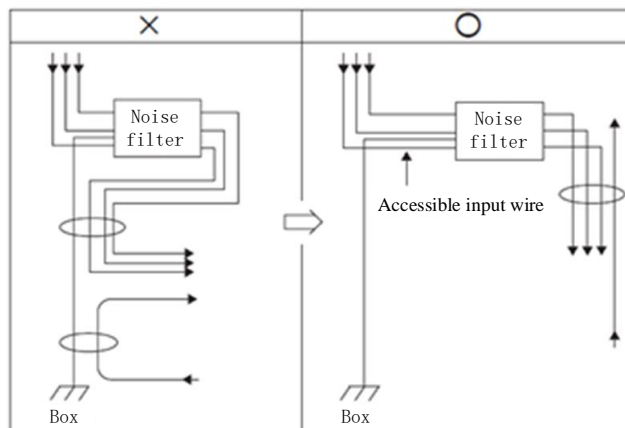

3. Connect the grounding wire of filter alone with grounding plate and do not connect other grounding wires.

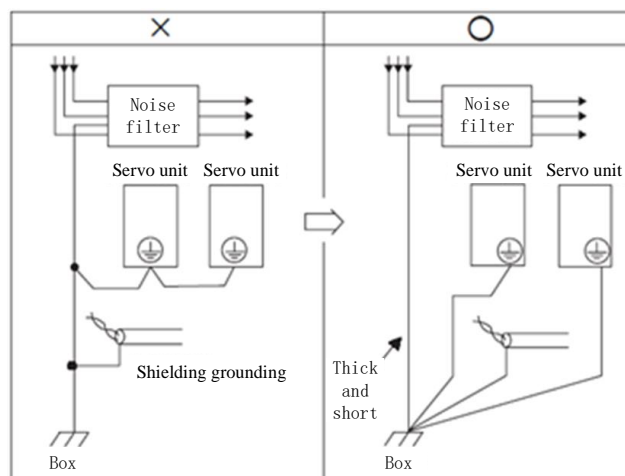

4. Processing of grounding wire of noise filter within a device

When there is a noise filter within a certain device, please connect the grounding wire of this filter and that of other machines to the bound grounding plate and then proceed to grounding.

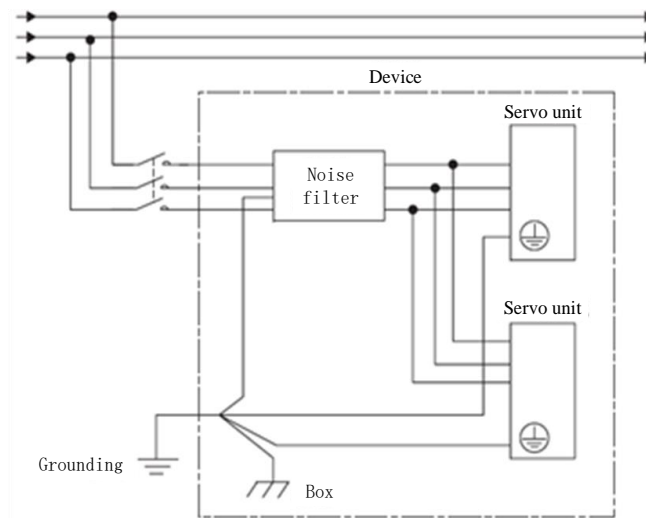

3.5 Wiring of Motor

3.5.1 Connector Terminal Wiring for Motor Power Supply

(1) Power socket (4-pin AMP and 4 straight pin aviation type) of series less than or equal to 90:

Terminal pin NO.	1	2	3	4
Signal	U	V	W	PE

(3) Power socket (4-pin) of series greater than or equal to 100:

Terminal pin no.	1	2	3	4
Signal	PE	U	V	W

4-pin AMP	4 straight pin bent type	4 straight pin aviation type
1-U, 2-V, 3-W, 4-PE	1-PE, 2-U, 3-V, 4-W	1-U, 2-V, 3-W, 4-PE

3.5.2 Connector Terminal Wiring for Motor Encoder

(1) Non-wire saving encoder socket (15-pin AMP) of series less than or equal to 90.

Terminal No.	1	2	3	4	5	6	7	8	9	10	11	12	13	14	15
Signals	PE	5V	GND	B+	Z-	U+	Z+	U-	A+	V+	W+	V-	A-	B-	W-

(2) Non-wire saving encoder socket (15-pin) of series greater than or equal to 110. Vacancy of U+, U-, V+, V-, W+,W- for wire-saving encoder.

Terminal No.	1	2	3	4	5	6	7	8	9	10	11	12	13	14	15
Signals	PE	5V	GND	A+	B+	Z+	A-	B-	Z-	U+	V+	W+	U-	V-	W-

(3) Wire-saving encoder socket (3 rows and 9-pin AMP)

Terminal No.	1	2	3	4	5	6	7	8	9
Signals	5V	GND	A+	A-	B+	B-	Z+	Z-	PE

(4) Motor absolute encoder socket (7-pin):





Terminal No.	1	2	3	4	5	6	7
Signals	PE	E-	E+	SD-	GND	SD+	+5V

Chapter IV Panel Operation

4.1 Basic Operation

4.1.1 Key Names and Functions

Through panel, such functions as switch of A-axis and b-axis display and operation, setting of various parameters, execution and status display of JOG running reference can be achieved. The following is a list of key names and functions.

Symbol	Name	Functions
	Function key	Basic function switch: status display, auxiliary function, parameter setting and monitoring Long press to switch between A-axis and b-axis display and operation
	UP	Press UP to increase set value Functioning as start key of positive rotation during JOG running in auxiliary function mode
	DOWN	Press DOWN to reduce set value Functioning as start key of negative rotation during JOG running in auxiliary function mode
	Shift key	Press the key to shift the selected bit (the decimal point of which flickers) one bit to the left
	SET	Press the key to display the setting and set value of parameters, and access parameter setting status and clear alarm

In the mode of status display, press SET to clear alarm, which can also be done by using alarm removal input signal/ALMRST.

Note: in case of alarm ringing, first eliminate alarm causes and then remove alarm.

4.1.2 Selection and Operation of Basic Mode

Through switching the basic modes of panel operator, such operations as running status display, parameter setting and running reference can be done.

Basic modes include status display mode, parameter setting mode, monitoring mode and auxiliary function mode. After Key M is pressed, the modes switch in the order as shown in the following figure.

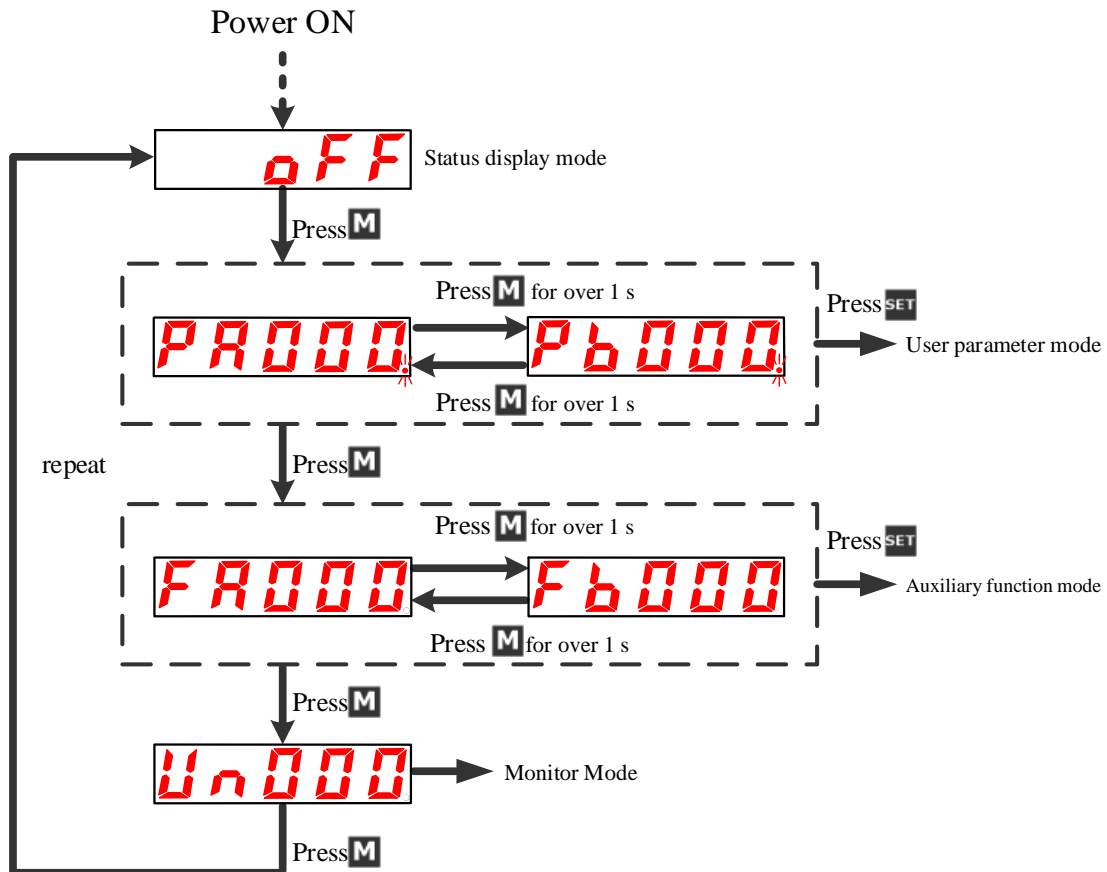

4.1.3 Status Display

Distinguishing method of status display is shown as below:

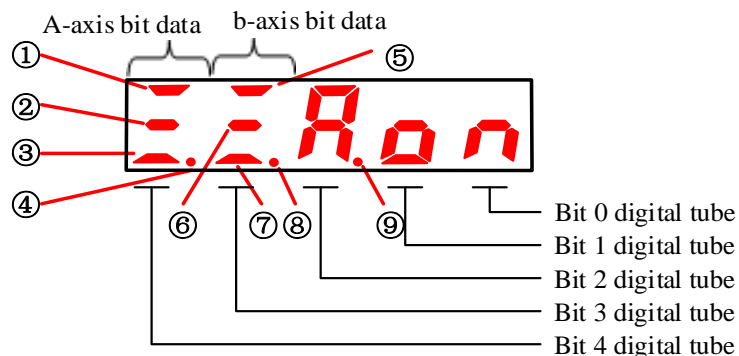







■ Display content of bit data

Item	Velocity/torque control mode		Position control mode	
	Bit data	Display content	Bit data	Display content
①	A axis Running	Light on when servo ON	A axis Running	Servo ON

		(power being supplied to motor)		(power being supplied to motor)
②	A axis Same speed (/V-CMP)	Light on when gap between motor speed and reference speed is lower than the specified value Specified value: PA503 (Factory default: 10 rpm)	A axis Positioning completed (/COIN)	Light on when offset of actual motor position and position reference is lower than the specified value Specified value: PA500 (Factory default: 10 pulse)
③	A axis Rotation detection (/TGON)	Light on when motor speed is higher than the specified value Specified value: PA502 (Factory default: 20 rpm)	A axis On rotation detection (/TGON)	Light on when motor speed is higher than the specified value Specified value: PA502 (Factory default: 20 rpm)
④	A axis P-OT/N-OT	Servo on limit: Light on indicates P-OT status Light off indicates N-OT status Flickering indicates P-OT/N-OT status	A axis P-OT/N-OT	Servo on limit: Light on indicates P-OT status Light off indicates N-OT status Flickering indicates P-OT/N-OT status
⑤	b axis Running	Light on when servo ON (power being supplied to motor)	b axis Running	Light on when servo ON (power being supplied to motor)
⑥	b axis Same speed (/V-CMP)	Light on when gap between motor speed and reference speed is lower than the specified value Specified value: PB503 (Factory default: 10 rpm)	b axis Positioning completed (/COIN))	Light on when offset of actual motor position and position reference is lower than the specified value Specified value: PA500 (Factory default: 10 pulse)
⑦	b axis Rotation detection (/TGON)	Light on when motor speed is higher than the specified value Specified value: PA502 (Factory default: 20 rpm)	b axis Rotation detection (/TGON)	Light on when motor speed is higher than the specified value Specified value: PA502 (Factory default: 20 rpm)
⑧	b axis P-OT/N-OT	Servo on limit: Light on indicates P-OT status; Light off indicates N-OT status; Flickering indicates P-OT/N-OT status;	b axis P-OT/N-OT	Servo on limit: Light on indicates P-OT status; Light off indicates N-OT status; Flickering indicates P-OT/N-OT status
⑨	Main power supply Ready	Light on when main circuit power is normal; Light off when main circuit power is cut off	Main power supply Ready	Light on when main circuit power is normal; Light off when main circuit power is cut off

■ Display content of abbreviated sign

Abbreviated signs	Display content
	A-axis and b-axis servos are OFF (no power being supplied to A-axis and b-axis motors)
	A-axis servo is ON (power being supplied to A-axis motor)

	b-axis servo is ON (power being supplied to b-axis motor)
	A-axis servo is P-OT/N-OT (required to be judged depending on P-OT/N-OT bits in A-axis bit display)
	b-axis servo is P-OT/N-OT (required to be judged depending on positive and negative rotation in b-axis bit display)
	A axis is in alarm state displaying alarm number
	b axis is in alarm state displaying alarm number

4.2 Auxiliary Function Mode (F□□□□)

4.2.1 Execution Mode List of Auxiliary Functions





This part describes the application operation of digital operator for motor running and adjustment. The following lists the user parameters of auxiliary function execution modes and their functions.









Auxiliary function NO.	Functions
F□000	Display of software version of servo
F□001	Position demonstration (effective only in position mode)
F□002	Jogging (JOG) mode running
F□003	Identification of load inertia percentage (compared to inertia of motor body)
F□004	User password authentication
F□005	Motor model confirmation
F□006	Manual adjustment of speed reference offset
F□007	Manual adjustment of torque reference offset
F□008	Automatic adjustment of (speed, torque) reference offset
F□009	Clear of multi-coil information data of bus encoder
F□010	Clear of internal errors of bus encoder
F□011	Initialization of user parameter setting
F□012	Display of history alarm data

Note: in the list "□" displaying "A" indicates it is now in A-axis auxiliary function mode, and displaying "b" indicates it is now in b-axis auxiliary function mode.

4.2.2 Display of Software Version of Servo











The following are operation steps for display of A-axis software version.

Operation steps	Operation instruction	Operation key	Display after operation
1	Press M function key and select auxiliary function mode to set the current mode as A-axis auxiliary function mode.		
2	Press M function key (for more than 1 second) and switch to auxiliary function mode of b axis, which will display Fb000.		

3	Press UP or DOWN and select the desired auxiliary function Fb000.		
4	Press SET and A-1.00 is displayed, which indicates processor program version is V1.00.		
5	Press Shift key and P-1.00 is displayed, which indicates FPGA program version is V1.00.		
6	Press SET key to return to the display of Fb000.		











4.2.3 Position Demonstration Operation

The following are operation steps for display of A axis position demonstration.

Operation steps	Operation instruction	Operation key	Display after operation
1	Press M function key (for more than 1 second) and switch to auxiliary function mode of A axis, which will display FA000.		
2	Press UP or DOWN and select the desired auxiliary function FA001.		
3	Press SET and "2PCLr" is displayed and initiate position demonstration operation.		
4	Press SET (for more than 1 second) until the display flickers "donE" to indicate position demonstration operation has been completed.		
5	Press SET to return to the display of FA001.		

4.2.4 Identification of Inertia Percentage

The following are operations steps for display of A-axis inertia percentage detected in normal mode (by turning 3 circles clockwise and another 3 circles counterclockwise).

Operation steps	Operation instruction	Operation key	Display after operation
1	Press M function key to select parameter setting mode for A-axis. If PA127 is not displayed, press UP or DOWN to set.		
2	Press SET to display "H1341.", whose decimal point in bit 0 flickers.		
3	Press shift key for three times and select Bit 3 of the displayed number, after which "H1.341" is displayed and the decimal point in Bit 3 flickers.		
4	Press UP and change the data to display "H2.341".		
5	Press SET to return to the previous menu.		

6	Press M function key and select the desired auxiliary function FA003.	M	FA003
7	Press SET to display the operation interface "-JIn-" for display of inertia identification percentage.	SET	-JIn-
8	Press M function key, initiate inertia identification operation by rotating motor 3 circles clockwise and another 3 circles counterclockwise, after which display flickers "donE".	M	donE
9	After detection, inertia percentage currently detected is displayed.	—	8
10	Press SET to return to the display of Fb000.	SET	Fb000

4.2.5 Confirmation of Motor Model

It is the function for confirming the model, capacity and encoder model of servo motor being controlled by servo driver.

Operation steps	Operation instruction	Operation key	Display after operation
1	Press M function key to select A-axis auxiliary function mode. If FA005 is not displayed, press UP or DOWN to set.	M	FA005
2	Press SET, and "A.0004" is displayed.	SET	A.0004
3	Press Shift key and "b.0220" is displayed.	<	b.0220
4	Press Shift key and "C.0010" is displayed.	<	C.0010
5	Press Shift key and "d.0020" is displayed.	<	d.0020
6	Press SET, and "A.0004" is displayed.	<	A.0004
7	Press SET to return to the display of Fb000.	SET	FA005

4.2.6 Initialization of User Parameter Setup

Operation steps to initialize A axis user parameter setup are as follows.

Operation steps	Operation instruction	Operation key	Display after operation
1	Press M function key to select auxiliary function mode for A axis. In case of failing to display FA011, press UP or DOWN to set.	^ v	FA011
2	Press SET to start parameter initialization.	SET	P.InIt

3	Press SET (for more than 1 second) until the display flickers "donE" to indicate A axis user parameter has been initialized.	SET	
4	Press SET to return to the display of FA011.	SET	

4.2.7 Displaying History Alarm Data

Ten previous alarms can be validated at most. The history alarm records can be cleared by a long press on SET. The history alarm data will not be cleared by alarm reset or servo power-off. Moreover, the alarm history data will not impact the operation.

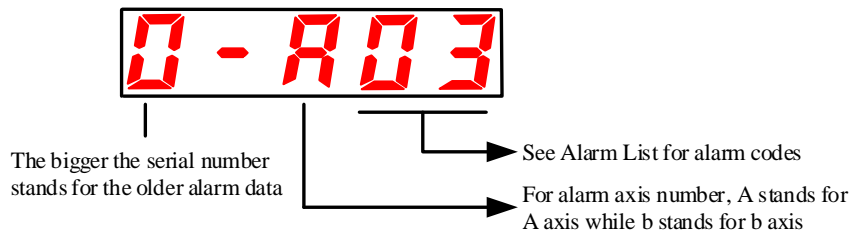

See "Abnormality Diagnosis and Treatment Methods" for alarm content.

- 1、 In case of continuous occurrence of the same alarm, the alarm history data will not update.
- 2、 The alarm history data displayed as "A--" or "b--" indicate zero alarm.

Validate the history alarm according to the following steps.

Operation steps	Operation instruction	Operation key	Display after operation
1	Press M function key to select auxiliary function mode for A axis. In case of failing to display FA012 press UP or DOWN to set.		
2	Press SET to display "0-A03" and the previous alarms.	SET	
3	Press UP to display the last history alarm (press DOWN to display the next new alarm).		
4	Press UP to display the alarms in order. * "A--" or "b--" indicates "Zero Alarm".		
5	Press SET to return to the display of Fb012.	SET	

4.3 Operation under User Parameter Mode (P□□□□)

Functions can be selected or adjusted by setting parameters. User parameters consist of "Parameter Setting" and "Function Selection". Parameter Setting functions to change the parameter data to be adjusted in a certain range and Function Selection works to select the functions distributed to bit numbers of penal operator.

4.3.1 User Parameter Setting







(1) Parameter setting

(a) Categories of "Parameter Setting"

See "List of User Parameters".

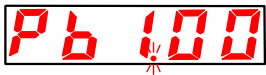
(b) Example to change "Parameter Setting"

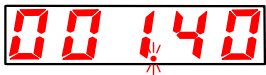
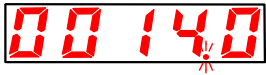
The Parameter Setting based user parameters specify data by numerical values directly. The range of change is validated by List of User Parameters. For example: the operation steps to change b axis user parameter Pb100 (Speed loop gain) from "40" to "100" are shown as follows.

Operation steps	Operation instruction	Operation key	Display after operation
1	Press M function key to select parameter setting mode	M	
2	Press M function key (for more than 1 second). Pb000 is displayed and the decimal point in Bit 0 flickers	M	
3	Press shift key twice and select Bit 2 of the displayed number. Pb0.00 is displayed and the decimal point in Bit 2 flickers	<	
4	Press UP to change the data and Pb1.00 is displayed	^	
5	Press SET to display current Pb100 data	SET	
6	Press shift key twice and select Bit 2 of the displayed number. 000.40 is displayed and the decimal point in Bit 2 flickers	<	
7	Press UP to change the data and 001.40 is displayed	^	
8	Press shift key for four times and select Bit 1 of the displayed number. 0014.0 is displayed and the decimal point in Bit 2 flickers	<	
9	Press DOWN to change the data and 001.00 is displayed	v	
10	Press SET to return to the display of Pb1.00. The content of b axis speed loop gain, Pb100, changes from "40" to "100"	SET	

(2) Function selection

(a) Categories of "Function Selection"

Also See "List of User Parameters".

(b) Example to change "Function Selection"

Example: the operation steps to change the control method (PA000.1) of basic switch PA000 for A axis function selection from speed to position are listed as follows.

Operation steps	Operation instruction	Operation key	Display after operation
1	Press M function key (for more than 1 second) and PA0.00 is displayed	M	

2	Press SET to display current PA000 data. The decimal point in Bit 0 flickers	SET	
3	Press shift key and select Bit 1 of the displayed number. H000.0 is displayed and the decimal point in Bit 1 flickers	<	
4	Press UP to change the data and H001.0 is displayed	^	
5	Press SET to return to the display of PA0.00 and the control approach for A axis has changed to position control	SET	

(c) User parametric representation of the Manual

The user parameters for function selection are represented with hexadecimal system and every bit of the set value has respective meaning.

User parameters for function selection in the Manual are represented as follows.

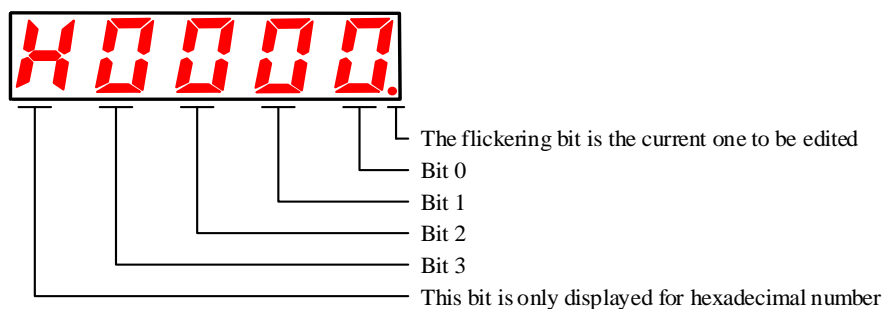

PA000.0 or A.Hxxx□ stands for the set value "0-bit data" of A axis user parameter "PA000".
 PA000.1 or A.Hxx□x stands for the set value "1-bit data" of A axis user parameter "PA000".
 PA000.2 or A.Hx□xx stands for the set value "2-bit data" of A axis user parameter "PA000".
 PA000.3 or A.H□xxx stands for the set value "3-bit data" of A axis user parameter "PA000".
 Pb000.0 or b.Hxxx□ stands for the set value "0-bit data" of b axis user parameter "Pb000".
 Pb000.1 or b.Hxx□x stands for the set value "1-bit data" of b axis user parameter "Pb000".
 Pb000.2 or b.Hx□xx stands for the set value "2-bit data" of b axis user parameter "Pb000".
 Pb000.3 or b.H□xxx stands for the set value "3-bit data" of b axis user parameter "Pb000".

4.3.2 Signal Distribution of Input Circuit

Input signals are distributed to the pins of input connector based on the user parameter setup. (Distribution list is shown as follows.)

(1) Factory setting

The default distribution is indicated in bold as follows.

(a) Factory settings of single-axis driver

PA509 = H.4321 PA510 = H.8765 PA511 = H.0000 PA512 = H.0000

(b) Factory settings of double-axis driver

PA509 = H.4321 PA510 = H.0000 PA511 = H.0000 PA512 = H.0000
 Pb509 = H.8765 Pb510 = H.0000 Pb511 = H.0000 Pb512 = H.0000

(2) Distribution change

User parameters are set based on the relation between use signal and input connector pin.
Moreover, when user parameters changes, the servo unit should be subject to "Power Off" →
"Power Restart" to make the user parameter take effect.

(a) List of input circuit signal distribution of single-axis driver:

Signal	Input signal	CN3 Pin no.								No connection required	
		14 (IN1)	15 (IN2)	16 (IN3)	17 (IN4)	39 (IN5)	40 (IN6)	41 (IN7)	42 (IN8)	Always invalid	Always valid
Servo ON PA509.0 = H.xxx□	/S-ON	1	2	3	4	5	6	7	8	0	9
Proportional action reference PA509.1 = H.xx□x	/P-CON	1	2	3	4	5	6	7	8	0	9
Positive-side over travel prohibited PA509.2 = H.x□xx	POT	1	2	3	4	5	6	7	8	0	9
Negative over travel prohibited PA509.3 = H.□xxx	NOT	1	2	3	4	5	6	7	8	0	9
Alarm reset PA510.0 = H.xxx□	/ALM-RST	1	2	3	4	5	6	7	8	0	9
Deviation counter reset PA510.1 = H.xx□x	/CLR	1	2	3	4	5	6	7	8	0	9
Positive-side external torque limit PA510.2 = H.x□xx	/PCL	1	2	3	4	5	6	7	8	0	9
Negative side external limit PA510.3 = H.□xxx	/NCL	1	2	3	4	5	6	7	8	0	9
Gain switch PA511.0 = H.xxx□	/G-SEL	1	2	3	4	5	6	7	8	0	9
Select internal position setting PA511.1 = H.xx□x	/POS0	1	2	3	4	5	6	7	8	0	9
Select internal position setting PA511.2 = H.x□xx	/POS1	1	2	3	4	5	6	7	8	0	9
Select internal position setting PA511.3 = H.□xxx	/POS2	1	2	3	4	5	6	7	8	0	9
Reference point switch PA512.0 = H.xxx□	/HOME-REF	1	2	3	4	5	6	7	8	0	9
Allow position start PA512.1 = H.xx□x	/POS-START	1	2	3	4	5	6	7	8	0	9
Position change step PA512.2 = H.x□xx	/POS-STEP	1	2	3	4	5	6	7	8	0	9
Homing start PA512.3 = H.□xxx	/START-HOME	1	2	3	4	5	6	7	8	0	9

Note: when multiple signals are distributed to the same input circuit, the input signal level will influence all the distributed signals.

(b) List of input circuit signal distribution of double axis driver:

Signal	Input signal	CN3 Pin no.								No connection required	
		14 (IN1)	15 (IN2)	16 (IN3)	17 (IN4)	39 (IN5)	40 (IN6)	41 (IN7)	42 (IN8)	Always invalid	Always valid
Servo ON PA509.0 = H.xxx□	/S-ON	1	2	3	4	5	6	7	8	0	9
Proportional action reference PA509.1 = H.xx□x	/P-CON	1	2	3	4	5	6	7	8	0	9
Positive-side over travel prohibited PA509.2 = H.x□xx	POT	1	2	3	4	5	6	7	8	0	9
Negative over travel prohibited PA509.3 = H.□xxx	NOT	1	2	3	4	5	6	7	8	0	9
Servo ON Pb509.0 = H.xxx□	/S-ON	1	2	3	4	5	6	7	8	0	9
Proportional action reference Pb509.1 = H.xx□x	/P-CON	1	2	3	4	5	6	7	8	0	9
Positive-side over travel prohibited Pb509.2 = H.x□xx	POT	1	2	3	4	5	6	7	8	0	9
Negative over travel prohibited Pb509.3 = H.□xxx	NOT	1	2	3	4	5	6	7	8	0	9
Alarm reset P□510.0 = H.xxx□	/ALM-RST	1	2	3	4	5	6	7	8	0	9
Positive-side external torque limit P□510.2 = H.x□xx	/PCL	1	2	3	4	5	6	7	8	0	9
Negative side external limit P□510.3 = H.□xxx	/NCL	1	2	3	4	5	6	7	8	0	9
Gain switch P□511.0 = H.xxx□	/G-SEL	1	2	3	4	5	6	7	8	0	9
Select internal position setting P□511.1 = H.xx□x	/POS0	1	2	3	4	5	6	7	8	0	9
Select internal position setting P□511.2 = H.x□xx	/POS1	1	2	3	4	5	6	7	8	0	9
Select internal position setting P□511.3 = H.□xxx	/POS2	1	2	3	4	5	6	7	8	0	9
Reference point switch P□512.0 = H.xxx□	/HOME-REF	1	2	3	4	5	6	7	8	0	9
Allow position start P□512.1 = H.xx□x	/POS-START	1	2	3	4	5	6	7	8	0	9
Position change step P□512.2 = H.x□xx	/POS-STEP	1	2	3	4	5	6	7	8	0	9
Homing start P□512.3 = H.□xxx	/START-HOME	1	2	3	4	5	6	7	8	0	9

Note:









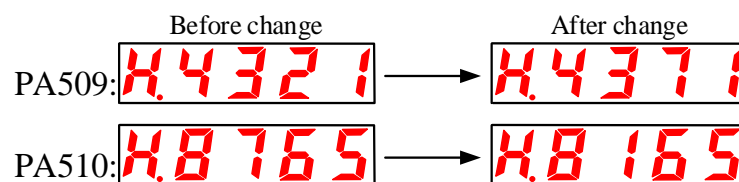







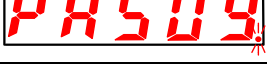

1. When multiple signals are distributed to the same input circuit, the input signal level will influence all the distributed signals.

2. The "□" of P□510、P□511、P□512 can be either "A" or "b".

(3) Example of input signal distribution

The steps to change the servo ON (/S-ON) distributed by single-axis driver to CN3-14 and the positive-side external torque limit (/PCL) distributed by single-axis driver to CN3-41 are listed as follows.



Operation steps	Operation instruction	Operation key	Display after operation
1	Press M function key to select parameter setting mode. In case of failing to display PA509, press UP or DOWN to set.		
2	Press SET to display current PA509 data. (Distribute /S-ON to CN3-14.)		
3	Press shift key and select Bit 1 of the displayed number. H.432.1 is displayed and the decimal point in Bit 1 flickers.		
4	Press UP or DOWN to set current bit as "7".		
5	Press SET to return to the display of PA509.		
6	Press UP or DOWN to set PA510.		
7	Press SET to display current PA510 data. (Distribute /PCL to CN3-41.)		
8	Press shift key twice and select Bit 2 of the displayed number. H.87.54 is displayed and the decimal point in Bit 2 flickers.		
9	Press UP or DOWN to set current bit as "1".		
10	Press SET to return to the display of PA510 and distribute /S-ON to IN7 (CN3-41) and /PCL to IN1 (CN3-14).		

(4) Polarity reversal setting of input port active level

Single/double-axis driver can set active level parameters of input port signals (PA519 and PA520) to reverse IN1-IN7 active level polarity.

Note:

1. When signals of Servo ON, Forward drive prohibited, and reverse drive Prohibited are used under "Polarity Reverse" setting, in case of any abnormality caused by signal line-off, no action will be made to safe direction. If such setup has to be made, validation on action and safety must be performed.

2. The reversal parameters of input port active level of double-axis driver are PA519, PA520, Pb519 and Pb520 with other setting invalid.

4.3.3 Signal Distribution of Output Circuit

(1) Factory setting

(a) Factory settings of single-axis driver:

PA513 = H.4321 PA514 = H.0065 PA521 = H.0000 PA522 = H.0000

(b) Factory settings of double-axis driver:

PA513 = H.0321 PA514 = H.0000 Pb513 = H.0654 Pb514 = H.0000

(2) Distribution change

The output circuits for sequence signals as follows can be used for function distribution. Moreover, when user parameters change, the servo unit should be subject to "Power Off" → "Power Restart" to make the user parameter take effect. The default distribution is indicated in the following gray box.

(a) List of output circuit signal distribution of single-axis driver:

CN3 Pin no.	7/(8)		9/(10)		11/(12)		32/(33)		34/(35)		36/(37)	
	OUT1		OUT2		OUT3		OUT4		OUT5		OUT6	
User parameter distribution	Polarity setting of signal output											
	PA521=H.xxx□		PA521=H.xx□x		PA521=H.x□xx		PA521=H.□xxx		PA522=H.xxx□		PA522=H.xx□x	
	0	1	0	1	0	1	0	1	0	1	0	1
Servo alarm (ALM) PA513.0=H.xxx□	0	Invalid										
	1	L	H									
	2			L	H							
	3					L	H					
	4							L	H			
	5									L	H	
	6											L
Positioning completed /same-speed detection (/COIN or /V-CMP) PA513.1=H.xx□x	0	Invalid										
	1	L	H									
	2			L	H							
	3					L	H					
	4							L	H			
	5									L	H	
	6											L
Motor rotation detection (/TGON) PA513.2=H.x□xx	0	Invalid										
	1	L	H									
	2			L	H							
	3					L	H					
	4							L	H			
	5									L	H	
	6											L
Servo ready (/S-RDY) PA513.3=H.□xxx	0	Invalid										
	1	L	H									
	2			L	H							
	3					L	H					
	4							L	H			
	5									L	H	
	6											L
Torque limit detection (/CLT) PA514.0=H.xxx□	0	Invalid										
	1	L	H									
	2			L	H							
	3					L	H					
	4							L	H			
	5									L	H	
	6											L
Brake (/BK) PA514.1=H.xx□x	0	Invalid										
	1	L	H									
	2			L	H							
	3					L	H					
	4							L	H			
	5									L	H	
	6											L
Encoder origin pulse (/PGC) PA514.2=H.x□xx	0	Invalid										
	1	L	H									
	2			L	H							
	3					L	H					
	4							L	H			
	5									L	H	
	6											L

Note:

- 1、 When ALM signals and other signals are distributed to the same output circuit, the output circuit only output ALM signals.
- 2、 When PGC signals and other signals rather than ALM are distributed to the same output circuit, the output circuit only output PGC signals.
- 3、 Multiple signals (except for ALM and /PGC) distributed to the same output circuit will be output through OR circuit.

(b) List of output circuit signal distribution of double-axis driver:

CN3 Pin no.	7/(8)		9/(10)		11/(12)		32/(33)		34/(35)		36/(37)	
	OUT1		OUT2		OUT3		OUT4		OUT5		OUT6	
User parameter distribution	Polarity setting of signal output											
	PA521=H.xxx□		PA521=H.xx□x		PA521=H.x□xx		PA521=H.□xxx		PA522=H.xxx□		PA522=H.xx□x	
	0	1	0	1	0	1	0	1	0	1	0	1
Servo alarm (ALM) PA513.0=H.xxx□	0	Invalid										
	1	L	H									
	2			L	H							
	3					L	H					
	4							L	H			
	5									L	H	
	6											L
Positioning completed /same-speed detection (/COIN or /V-CMP) PA513.1=H.xx□x	0	Invalid										
	1	L	H									
	2			L	H							
	3					L	H					
	4							L	H			
	5									L	H	
	6											L
Motor rotation detection (/TGON) PA513.2=H.x□xx	0	Invalid										
	1	L	H									
	2			L	H							
	3					L	H					
	4							L	H			
	5									L	H	
	6											L
Servo alarm (ALM) Pb513.0=H.xxx□	0	Invalid										
	1	L	H									
	2			L	H							
	3					L	H					
	4							L	H			
	5									L	H	
	6											L
Positioning completed /same-speed detection (/COIN or /V-CMP) Pb513.1=H.xx□x	0	Invalid										
	1	L	H									
	2			L	H							
	3					L	H					
	4							L	H			
	5									L	H	
	6											L
Motor rotation detection (/TGON) Pb513.2=H.x□xx	0	Invalid										
	1	L	H									
	2			L	H							
	3					L	H					
	4							L	H			
	5									L	H	
	6											L
Servo ready (/S-RDY) P□513.3=H.□xxx	0	Invalid										
	1	L	H									
	2			L	H							
	3					L	H					
	4							L	H			
	5									L	H	
	6											L
Torque limit detection (/CLT) P□514.0=H.xxx□	0	Invalid										
	1	L	H									
	2			L	H							
	3					L	H					
	4							L	H			
	5									L	H	
	6											L
Brake (/BK) P□514.1=H.xx□x	0	Invalid										
	1	L	H									
	2			L	H							
	3					L	H					
	4							L	H			
	5									L	H	
	6											L
Encoder origin pulse (/PGC) P□514.2=H.x□xx	0	Invalid										
	1	L	H									
	2			L	H							
	3					L	H					
	4							L	H			
	5									L	H	
	6											L

Note:

- 1、 When ALM signals and other signals are distributed to the same output circuit, the output circuit only output ALM signals.
- 2、 When PGC signals and other signals rather than ALM are distributed to the same output circuit, the output circuit only output PGC signals.
- 3、 Multiple signals (except for ALM and /PGC) distributed to the same output circuit will be output through OR circuit.

(3) Example of output signal distribution

Steps to invalidate the default setting to distribute rotation detection (/TGON) to CN3-11(12) and replace CN3-11(12) with Brake Signal Distribution.

Operation steps	Operation instruction	Operation key	Display after operation
1	Press M function key to select parameter setting mode. In case of failing to display PA513, press UP or DOWN to set.	M	PA513
2	Press SET to display current PA513 data. (Distribute /TGON to CN3-11(12).)	SET	H.4321
3	Press shift key twice and select Bit 2 of the displayed number. H.43.21 is displayed and the decimal point in Bit 2 flickers.	<	H.43.21
4	Press UP or DOWN to set current bit as "0".	^ v	H.4021
5	Press SET to return to the display of PA513.	SET	PA513
6	Press UP or DOWN to set PA514.	^ v	PA514
7	Press SET to display current PA514 data. (Distribute /BK to CN3-36(37).)	SET	H.0065
8	Press shift key and select Bit 1 of the displayed number. H.006.1 is displayed and the decimal point in Bit 5 flickers.	<	H.006.1
9	Press UP or DOWN to set current bit as "3". (Distribute TGON to CN3-11(12))	^ v	H.0035
10	Press SET to return to the display of PA514 and distribute /TGON to OUT3:CN3-11(12).	SET	PA514

4.4 Operation under Monitoring Mode (Un□□□)

Under monitoring mode, the reference value input to A axis or b axis servo driver, status of input/output signals and servo internal status can be monitored. Even though the servo motor is running, the monitoring mode can be changed.

4.4.1 List of Monitoring Mode

(1) Content displayed under monitoring mode

Monitor number	Display content	Unit
Un000	Motor speed	1r/min
Un001	Rotation angle (electric angle)	1deg
Un002	Input reference pulse speed (only valid under position control mode)	1 KHz
Un003	Bus voltage	1 V
Un004	Speed reference value of analogue input	1r/min
Un005	Torque reference percentage of analogue input (relative rated torque)	1 %
Un006	Internal torque reference (relative rated torque or given motor currency)	1% or 0.1A
Un007	Input port signal monitoring	—
Un008	Output port signal monitoring	—
Un009	Encoder signal monitoring (only valid for incremental encoder)	—
Un010	Input reference pulse counter (32-bit decimal display, only valid under position control mode)	1-reference pulse
Un011	Feedback pulse counter (four-octave frequency data of encoder pulse, 32-bit decimal display)	1-reference pulse
Un012	Position offset counter (only valid under position control mode)	1-reference pulse
Un013	Accumulative load rate (when rated torque is set as 100%)	1 %
Un014	Ratio of moment of inertia (the ratio of load moment inertia to motor moment inertia)	1 %
Un015	Actual encoder angle (32-bit decimal display)	1-reference pulse
Un016	Display rounds of encoder (only valid for turns of encoder)	1 circle

(2) Monitor display for input/output signals for sequence

Monitor display for input/output signals for sequence

(a) Monitor display of input signal status

Display the input/output status of the signals distributed to input/output terminals.

When input/output is OFF (open circuit), the upper display segment (LED) will be on.

When input/output is ON (short circuit), the lower display segment (LED) will be on.

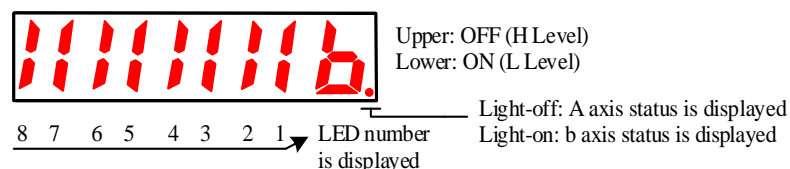

Validate the relation between input terminals and input signals according to "7.3.2 Signal Distribution of Input Circuit".

Monitor number	LED number is displayed	Name of input terminal	Factory settings	
			Single-axis	Double-axis
Un007	1	IN1 (CN3-14)	/S-ON	A axis /S-ON
	2	IN2 (CN3-15)	/P-CON	A axis /P-CON

Monitor number	LED number is displayed	Name of input terminal	Factory settings	
			Single-axis	Double-axis
	3	IN3 (CN3-16)	POT	A axis POT
	4	IN4 (CN3-17)	NOT	A axis NOT
	5	IN5 (CN3-39)	/ALM-RST	b axis /S-ON
	6	IN6 (CN3-40)	/CLR	b axis /P-CON
	7	IN7 (CN3-41)	/PCL	b axis POT
	8	IN8 (CN3-42)	/NCL	b axis NOT

(b) Monitor display of output signal status

Display the status of the output signals distributed to output terminals.



When output is OFF (open circuit), the upper display segment (LED) will be on.





When output is ON (short circuit), the lower display segment (LED) will be on.

Monitor number	LED number is displayed	Name of input terminal	Factory settings	
			Single-axis	Double-axis
Un008	1	OUT1 (CN3-7,-8)	ALM	A axis ALM
	2	OUT2 (CN3-9,-10)	/COIN or /V-CMP	A axis/COIN or /V-CMP
	3	OUT3 (CN3-11,-12)	/TGON	A axis/TGON
	4	OUT4 (CN3-32,-33)	/S-RDY	b axis ALM
	5	OUT5 (CN3-34,-35)	/CLT	b axis/COIN or /V-CMP
	6	OUT6 (CN3-36,-37)	/BK	b axis/TGON
Un009 (Only valid for incremental encoder)	1	PW (CN□-12,-13)	<input type="checkbox"/> axis encoder W-phase (<input type="checkbox"/> represents for 1 or 2)	
	2	PV (CN□-10,-11)	<input type="checkbox"/> axis encoder V-phase	
	3	PU (CN□-8,-9)	<input type="checkbox"/> axis encoder U-phase	
	4	UVW off line detection signal	<input type="checkbox"/> axis UVW off line detection	
	5	PC (CN□-5,-6)	<input type="checkbox"/> axis encoder C-phase	
	6	PB (CN□-3,-4)	<input type="checkbox"/> axis encoder B-phase	
	7	PA (CN□-1,-2)	<input type="checkbox"/> axis encoder A-phase	
	8	ABC off line detection signal	<input type="checkbox"/> axis UVW off line detection	

(3) Use of monitoring mode











Operation steps to display b axis Un000 data are listed as follows (when A axis and b axis servo motor rotate at 1000 and 1500 r/min respectively)

Operation steps	Operation instruction	Operation key	Display after operation
1	Press M mode key to select monitoring mode	M	
2	Press UP or DOWN and select the desired monitor number Un000	▲ ▼	
3	Press SET to display Un000. The decimal point of current Bit 0 is off, so A axis Un000 is displayed	SET	

4	Press UP or Down, the decimal point of current Bit 0 is on, so b axis Un000 is displayed		
5	Press SET to return to the display of monitor number.		

(4) Monitor display of reference pulse, feedback pulse counter and actual angle of encoder

Operation steps to display b axis Un010 data are as follows.

Operation steps	Operation instruction	Operation key	Display after operation
1	Press M function key to select A axis monitoring mode. In case of failing to display Un010, press UP or DOWN to set.		
2	Press SET to display Un010. The decimal point of current Bit 0 is off, so low 16-bit of A axis Un010 is displayed.		
3	Press UP or Down, the decimal point of current Bit 0 is on, so low 16-bit of b axis Un010 is displayed.		
4	Press Shift key, the decimal point of current Bit 0 is on, so high 16-bit of b axis Un010 is displayed.		
5	Press SET to return to the display of monitor number.		

Chapter V Operation

5.1 Trial Operation

Perform trial operation after wiring.

5.1.1 Trial Operation for Servo Motor Unit

Notes

- Disconnect the servo motor and machinery and only fix the servo motor unit.
To avoid accident, based on the instruction, trial operation is performed on a servo motor under unloaded status (where the servo motor unit connects with no coupling or belt).

Validate whether the power, motor main circuit and encoder cables are wired correctly. Usually, wiring mistake may cause the motor fail to rotate smoothly in trial operation. Please validate again.

When the wiring is validated as correct, perform trial operation for servo motor units based on the following serial number in order.

- Jogging (JOG) and mode running (F□002)

The following are operation steps for display of axis A JOG operation.

Operation steps	Operation instruction	Operation key	Display after operation
1	Press M function key (for more than 1 second) and switch to auxiliary function mode of axis A.	M	FA000
2	Press M function key to select auxiliary function mode for A axis. In case of failing to display FA002, press UP or DOWN to set.	^ v	FA002
3	Press SET to start JOG operation.	SET	A-.JOG
4	Press M function key to turn the servo ON (the motor is powered on).	M	A=.JOG
5	Press UP (turn anti-clockwise/ positive) or DOWN (turn clockwise/ negative) to run the motor.	^ v	A=.JOG
6	Press M function key to turn the servo OFF (the motor is powered off).	M	A-.JOG
7	Press SET to return to the display of FA002.	SET	FA002

P□304	Jogging (JOG) speed			Speed	Position	Torque
	Setting range	Setting unit	Factory setting	Power reboot		
	0 ~ 6000	1rpm	500	Not required		
Set the motor speed command value for auxiliary function "Jogging (JOG) Mode Running (Fn002)".						

Pay attention, in the operation under jogging (JOG) mode, it is invalid to disable Forward Drive Prohibited (P-OT) or Reverse Drive Prohibited (N-OT).

5.1.2 Trial Operation for Servo Motor Unit with Superior Reference

This item is to validate whether the servo motor moving reference and input/output signals from the command controller to the servo unit are correctly set, whether the wiring and polarity between command controller and servo unit are correct and whether the movement setting of servo unit is correct. This is the final validation before connecting the servo motor to machinery.

(1) Servo ON reference based on superior reference

The following external input signal circuits and equivalent signal circuits must be configured.

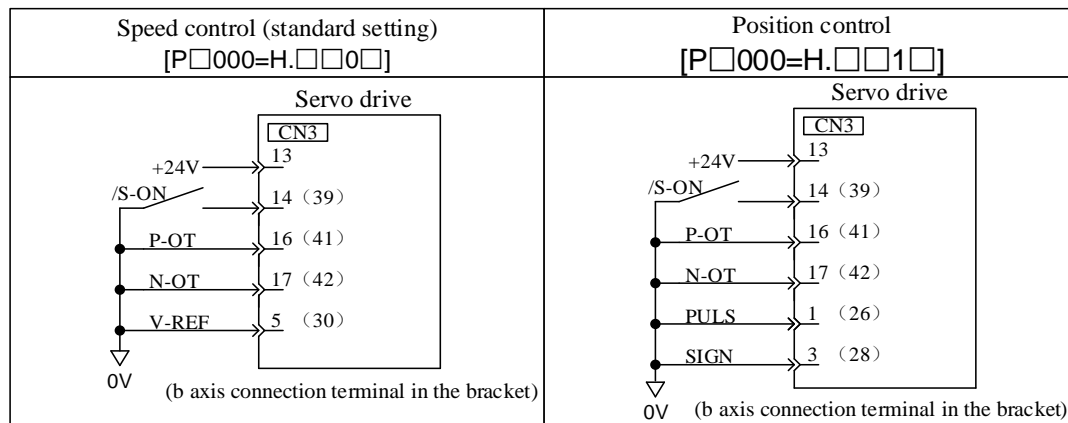

Step	Content	Verification methods and supplementary instruction
1	<p>Form the input signal circuit required by servo ON.</p> <p>To turn the servo ON, the minimum required signal should be input. Please wire the input/output signal connector (CN3) in the circuit equivalent to the circuit shown in the preceding page, power it off and connect CN3 to servo unit.</p>	<p>Please set as follows.</p> <ol style="list-style-type: none"> Input servo On and input signal (/S-ON) Turn On (L level) input signals of Forward Drive Prohibited (P-OT) and Reverse Drive Prohibited (N-OT) (forward drive prohibited and reverse drive prohibited can be performed) Do not input reference (0V reference or 0 pulse) <p>If the external wiring is to be omitted, the input signal distribution function based on user parameters can be used to set the function of input terminal as “Always Valid”, “Always Invalid” without signal input. Please refer to “Signal Distribution of Input Circuit”.</p> <p>When absolute value encoder is used, if “Use Absolute Encoder as Incremental Encoder (Pn001=H.□□□2)” is set temporarily, wiring for SEN signals can be omitted.</p>
2	<p>Please power on to check whether the panel operator displays content as follows.</p> <div style="display: flex; align-items: center; margin-bottom: 10px;"> <div style="border: 1px solid black; padding: 2px; margin-right: 5px;">- 0.F F</div> ← For single-axis </div> <div style="display: flex; align-items: center;"> <div style="border: 1px solid black; padding: 2px; margin-right: 5px;">- - 0.F F</div> ← For double-axis </div>	<p>If the content is not displayed as shown in the left figure, the setting of the input signals is incorrect. Please validate the input signals with input signal monitor (Un007).</p> <p>For single-axis: Un007= </p> <p>For double-axis: Un007= </p> <p>Turn the connected signal lines ON/Off to validate that the LED display of the digital operator changes as follows.</p>
3	<p>Input servo ON input signal (/S-ON) and validate that the display of panel operator is shown as follows.</p>	<p>When any alarm appears, see "Abnormality Diagnosis and Treatment Methods" to eliminate the alarm.</p>

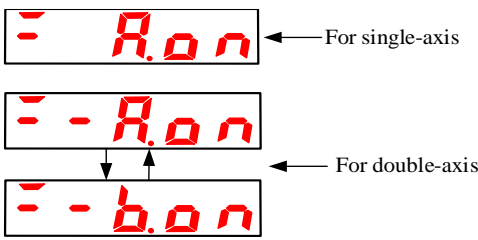
	<p>In case of interference in reference voltage during speed control, “-” in the upper left part of the panel operator will flash. When the servo is ON, the servo motor might run at dead slow speed. For such occasion, please refer to “Other Wiring” to take corresponding measures.</p>
---	--

(2) Operation steps under speed control mode (P□000=H. □□0□)

The following external input signal circuits and equivalent signal circuits must be configured.

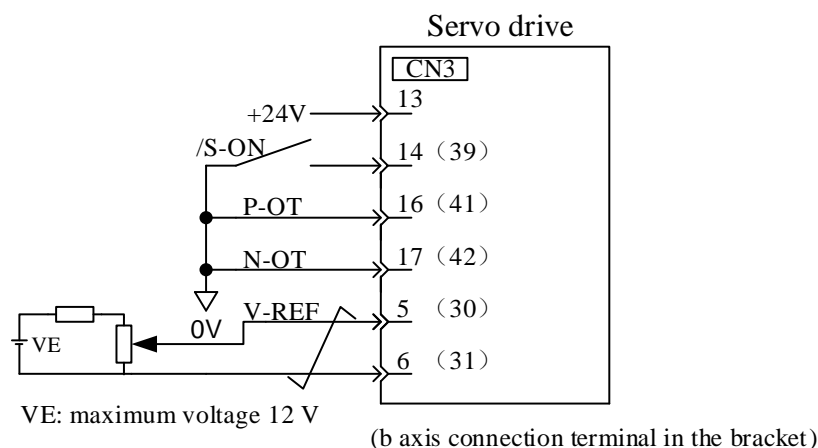

Step	Content	Verification methods and supplementary instruction
1	Please check the power and input signal circuit again and check the speed reference input (voltage between V-REF and GND) is 0 V.	Please refer to the input signal circuit shown in the above figure.
2	Turn on the servo ON(/S-ON) input signal.	If the servo motor rotates at an extremely slow speed, see “Adjustment of Reference Shift”,and use the reference voltage offset to keep the servo motor from moving.
3	Increase the speed reference input voltage (between V-REF and GND) slowly from 0 V with.	Factory setting: 150(r/min)/V.
4	Please validate the speed reference (Un004[r/min]) value input to servo driver.	See "Selection and Operation of Basic Mode" for relevant display methods.
5	Please validate servo motor speed (Un000[r/min]).	See "Selection and Operation of Basic Mode" for relevant display methods.
6	Please validate the values of Step 4 and 5 (Un004 and Un000) are equivalent.	Change speed reference input voltage to validate whether Un004 = Un000 is valid when there are multiple speed reference values.
7	Please validate the speed reference input or motor rotation direction.	Refer to the following equation when speed reference input gain (P□300) changes. $Un004 = P□300[rpm/V] \times (V-REF \text{ voltage})[V]$ To change the motor rotation direction without changing speed reference input voltage polarity, see “Rotation Direction Switching of Motor”. Start from Step 2 after change.
8	If the servo is OFF when the speed input reference is set as 0 V, the trial operation of servo motor unit has completed.	

Note: The position control is configured in command controller

When servo is under speed control and subject to position control in command controller, please validate the following items after the said “Operation Steps under Speed Control Mode”.

Step	Content	Verification methods and supplementary instruction
9	Please validate the power and input signal circuit again and validate the speed command input (voltage between V-REF and GND) is 0 V.	
10	Set servo ON(/S-ON) input signal as ON.	If the servo motor rotates at an extremely slow speed, see "Adjustment of Reference Shift", and use the reference voltage offset to keep the servo motor from moving.
11	Give the motor rotation reference (e.g., the motor rotates 1 round) easy to validate in advance from command controller and validate the motor rotation commanded and realized by visual inspection and monitoring motor actual angle (Un015[pulse]).	Motor rotation angle 1 (Un015[pulse]): the pulse count starting from original point.
12	In case of rotation difference of Step 11, please properly set the PG frequency dividing ratio (Pn201) that outputs encoder pulse from servo unit.	See "Encoder Signal Output" for relevant setting method. PG frequency dividing ratio (Pn201[P/Rev]): the encoder pulse count per rotation round.
13	If the servo is OFF when the speed input reference is set as 0 V, the trial operation to set the reference control as position control has completed.	

(3) Operation steps under position control mode (P□000=H. □□1□)

The following external input signal circuits and equivalent signal circuits must be configured.

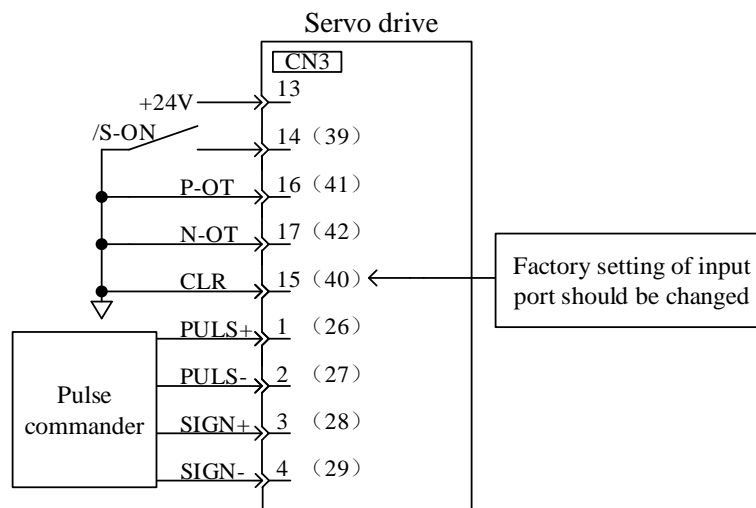

(b axis connection terminal in the bracket)

Step	Content	Verification methods and supplementary instruction
1	Please validate the conformity between pulse shape and the pulse output from the superior pulse commander.	Reference pulse shape is set with P□200=H.××□×. Please refer to "Setting of User Parameter".
2	Set command unit and set electronic gear ratio based on command controller.	Electronic gear ratio is set with (Pn202/Pn203). Please refer to "Setting of Electronic Gear".
3	Power on and set servo ON(/S-ON) input signal as ON.	
4	Use the motor rotation to be easily validated in advance (e.g., motor rotates 1 round) to output slow reference pulse from command controller.	Set the reference pulse rate as the safe rate around 100 r/min.
5	Please validate the reference pulse count input to servo unit with the variation before and after inputting the reference of reference pulse counter ((Un010[pulse]).	See "Selection and Operation of Basic Mode" for relevant display methods. Un010(input reference pulse counter [pulse])
6	Please validate the actual rotation of the motor before/after change of feedback pulse counter (Un011[pulse]).	See "Selection and Operation of Basic Mode" for relevant display methods. Feedback pulse counter (Un011 [pulse])
7	Please validate that Step 5 and 6 meet the following conditions.	

	Un011=Un010	
8	Please validate the conformity of rotation direction with the servo motor giving reference.	Please validate the input pulse polarity and input reference pulse shape. Please refer to "Selection of Pulse Reference shape".
9	Please validate motor rotation direction.	To change the motor rotation direction without changing input reference pulse shape, see "Rotation Direction Switching of Motor". Start from Step 9 after change.
10	If the servo will be OFF when the pulse reference input stops, the trial operation under servo motor unit position control mode using superior position reference has completed.	

5.1.3 Trial Operation Servomotor Connected to the Machine

Danger

- Please carry out operations indicated in this section as per instructions.
Upon connection between servo motor and machinery, in case of operation mistake, not only damages to machinery but also personal injuries will be caused therefrom.

The steps are specified on the condition that trial operation has been completed in each control.

Step	Content	Verification methods and supplementary instruction
1	Switch on power and set mechanical configuration in respect of protection functions for overtravel and brake.	Please refer to "Setting of General Basic Functions". When using servo motor with brake, measures against natural falling of machinery and vibration caused by external force should be taken prior to confirmation of brake operation. Please check whether operations for servo motor and brake are normal. Please refer to "Setting for Holding Brake".
2	Please set necessary parameters for users based on used control mode.	Based on used control mode, please refer to: the Speed Control (Analog Voltage Reference) Operation the Position Control Operation the Torque Control Operation
3	Please connect to servo motor and machinery via coupling with power being cut off.	Please refer to "Installation Precautions for Servo Motor".
4	When servo controller is turned to "Servo Off" mode (de-energized state), switch on power of command controller of machinery. Please confirm once again whether operation of protection functions in step 1 is normal.	Please refer to "Setting of General Basic Functions". In case of any abnormality during operation of following step, emergency stop may be carried out to safely stop operation.
5	Please carry out trial operation in accordance with objectives specified in the Trial Operation for Servo Motor Unit Based on Superior Reference upon completed installation of machinery and servo motor.	Please check whether results are in line with trial operation of servo motor unit. In addition, please check whether settings like reference unit conform to that of machinery.
6	Please confirm once again whether user parameter settings conform to control mode in step 2.	Please check whether servo motor operates according to specification for machinery operation.
7	Please adjust servo gain as necessary to improve responsiveness of servo motor.	Trial operation should be fully completed since insufficient "running-in" with machinery may occur in the trial operation.
8	Please record the user parameters set for maintenance in the 12.4 User Parameter Setting Memo. At this point, the Supporting Trial Operation for Machinery and Servo Motor is completed.	

5.1.4 Trial Operation of Servomotor with Brakes

In terms of a servo motor with brake, operation for its holding brake should be controlled by interlocking output (/BK) signals of the brake in servo driver.

Measures against natural falling of machinery and vibration caused by external force should be taken prior to confirmation of brake operation. Please check operations of servo motor and holding brake upon disconnection between servo motor and machinery. If operations are normal, servo motor may be connected to machinery for trial operation.

Please refer to "Setting for Holding Brake" for wiring of servo motor with brake and settings for user parameters.

5.1.5 Position Controlled by Command Controller

According to the above mentioned, make sure that trial operation for servo motor unit should be conducted after disconnection of servo motor and machinery, Please confirm operation and specification of servo motor first based on the following table.

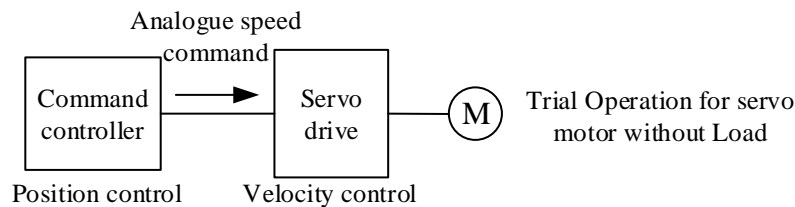

Commands of command controller	Confirming matters	Confirming methods	Re-corrected content	Reference
JOG operation (Reference with certain speed input by command controller)	RPM of servo motor	Confirm speed of servo motor by the following methods. <ul style="list-style-type: none"> •RPM monitoring for motor using panel operator (Un000) •Try to operate servo motor at a lower speed. For example, input a speed reference of 60r/min and check whether the servo motor rotates 1 round per second. 	Please determine whether input gain (P□300) of speed command is correct via confirmation of setting values of user parameters.	
Simple positioning	Rotation amount of servo motor	After inputting a reference to order the servo motor to rotate 1 round, visually inspect whether the shaft of servo motor rotates 1 round.	Please determine whether PG divider ratio (P□201) is correct via confirmation of setting values of user parameters.	
Overtravel operation (when using POT and NOT signals)	Input POT and NOT signals and check whether the servo motor stops.	During continuous rotation of servo motor, make sure that servo motor stops after POT and NOT signals is switched to be ON.	If it fails to be stopped, correct wiring of POT and NOT again.	

5.2 Selection of Control Mode

Control modes applicable to servo driver are explained as follows:

User Parameter	Control modes	Reference
----------------	---------------	-----------

P□000	H.□□0□	Speed control (analog voltage reference) Control RPM of servo motor by reference of analog voltage speed in case of: ·required RPM control ·feedback from frequency dividing output by encoder of servo; setting position loop in command controller; and implementation of position control	
	H.□□1□	Position control (pulse train reference) Control position of servo motor via reference of pulse train position. Control position via number of incoming pulse and control speed via frequency of incoming pulse. Use it if in need of positioning operation.	
	H.□□2□	Torque control (analog voltage reference) Control output torque of servo motor by analog voltage torque reference which should be used if required amount of torque for operations such as pressing.	
	H.□□3□	Speed control (selection of internal set speed) With 3 input signals (/P-CON, /P-CL and /N-CL), speed is controlled by operation speed set by servo in advance. 3 operation speeds can be set for the servo without analog voltage reference.	
	H.□□3□ · · ·	It is supporting switching modes for the above 4 control modes. Please select an applicable switching mode of control mode for purposes of clients.	
	H.□□B□ H.□□C□	Motion control mode	

5.3 Setting of General Basic Functions

5.3.1 Servo ON Setting

Set the servo ON signal (/S-ON) which sends out commands for energized/de-energized state of servo motor.

(1) Servo ON signal (/S-ON)

Name	Signal	Pin No. of connector (factory)		Set	Meanings
		A axis	B axis		
Input	/S-ON	CN3-14	CN3-39	ON = L Level	Servo motor can operate in energized state (servo ON state).
				OFF = H Level	Servo motor cannot operate in de-energized state (servo OFF state).
<p>■Attentions</p> <p>Make sure that commands are input to start/stop servo motor after sending servo ON signal. Do not use /SON signal to start/stop servo motor after inputting commands. In case of repeated switching between ON and OFF modes for AC power, accidents may be caused by aging of internal components.</p> <p>/S-ON signals may distribute inputted connector pin numbers to other places by user parameters.</p>					

(2) Select to use/disuse servo ON signal

Regular servo ON can be set by user parameters without wiring of /S-ON, however, servo driver is switched to action state when power is on, therefore you should handle with care.

User Parameter		Meanings	
P□509	A axis	H.□□1□	Input /S-ON signal via the input terminal IN1(CN3-13) (factory setting)
		H.□□9□	Set the /S-ON signal to be "valid " in regular time
	B axis	H.□□5□	Input /S-ON signal via the input terminal IN5 (CN3-39) (factory setting)
		H.□□9□	Set the /S-ON signal to be "valid " in regular time
<p>·Power must be turned on again upon changes to the user parameter so as to effect the setting.</p> <p>·When the signal is set to be "valid " in regular time, reset can be realized by power restarting in case of alarm (alarm reset is invalid).</p>			

5.3.2 Rotation Direction Switching of Motor

In this case, only reverse the rotation direction of motor without changes to pulse and voltage polarity of commands being sent into servo driver.

At the same time, moving direction (+, -) of shaft is reversed but polarity for output signals from servo (such as pulse output of encoder and analog monitor signal) is kept unchanged.

In standard setting, "forward direction" is observed to be "counterclockwise rotation" from the loading side of servo motor.

User Parameter	Name	Command	
		rotation reference	Negative rotation reference
P□000	H.□□□0 Standard setting (CCW refers to forward rotation) (Factory setting)	<p>Positive rotation (CCW)</p> <p>Encoder output pulse PAO PBO A phase advance</p>	<p>Negative rotation (CW)</p> <p>Encoder output pulse PAO PBO B phase advance</p>
	H.□□□1 Negative rotation mode (CW refers to forward rotation)	<p>Negative rotation (CW)</p> <p>Encoder output pulse PAO PBO A phase advance</p>	<p>Positive rotation (CCW)</p> <p>Encoder output pulse PAO PBO B phase advance</p>

In terms of direction switching of POT and NOT, CCW direction is POT if P□000= H.□□□0 (standard setting) and CW direction is POT if P□000= H.□□□1 (negative rotation mode).

5.3.3 Overtravel Setting

The overtravel limit function forces movable machine parts to stop if they exceed the allowable range of motion and turn ON a limit switch.

(1) Connection of overtravel signal

In order to use overtravel function, connect input signals of the following overtravel limit switch to corresponding pin numbers in CN3 connector of servo driver without fail.

Type	Signal	Pin No. of connector (factory)		Set	Meanings
		A axis	B axis		
Input	POT	CN3-16	CN3-41	ON = L Level	Positive-side over travel allowed. (normal operation)
				OFF = H Level	Positive-side over travel prohibited (overtravel in positive rotation side)
Input	NOT	CN3-17	CN3-42	ON = L Level	Negative-side over travel allowed. (normal operation)
				OFF = H Level	Negative-side over travel prohibited (overtravel in negative rotation side)

In respect of linear drive, limit switches must be connected according to the following figure so as to avoid machinery damage.

Even in case of overtravel, it can also drive to the opposite side. For example, negative-side run can be enabled in case of positive-side overtravel.

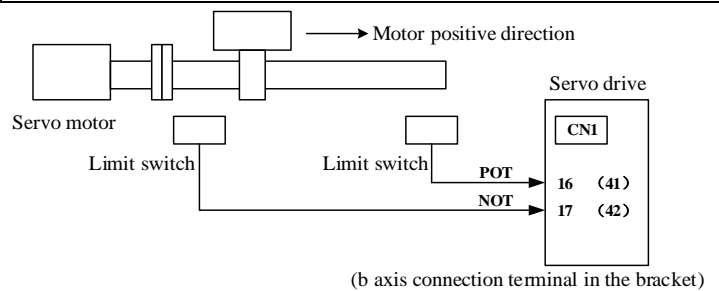

■Attentions

During position control, position error pulse will occur if the motor is stopped by overtravel. In order to clear position error pulse, clear signals (CLR) must be input.

Notes

Workpieces may fall under the overtravel state when using servo motor in vertical shaft.
In order to prevent workpieces from falling in case of overtravel, make sure to set P□000= H.1□□□ so as to switch on zero clamping state after stop. (Please refer to "Selection of Motor Stop Methods when Using Overtravel")

(2) Select to use/disuse overtravel signal

Internal user parameters of servo driver can be set to disuse overtravel signals. At this time, it is not required to use wiring of input signals for overtravel.

User Parameter		Meanings	
P□509	A axis	H.□3□□	Input positive-side over travel prohibited (POT) signal from IN3 (CN3-13). (Factory setting)
		H.□9□□	Disable the positive-side over travel prohibited (POT) signal (positive-side over travel can be conducted frequently)
	B axis	H.□7□□	Input positive-side over travel prohibited (POT) signal from IN7 (CN3-41). (Factory setting)
		H.□9□□	Disable the positive-side over travel prohibited (POT) signal (positive-side over travel can be conducted frequently)
	A axis	H.4□□□	Input negative-side over travel prohibited (NOT) signal from IN4 (CN3-14). (Factory setting)
		H.9□□□	Disable the negative-side over travel prohibited (NOT) signal (negative-side over travel can be conducted frequently)
	B axis	H.9□□□	Input negative-side over travel prohibited (NOT) signal from IN8 (CN3-42). (Factory setting)
		H.9□□□	Disable the negative-side over travel prohibited (NOT) signal (negative-side over travel can be conducted frequently)

·Effective control modes: speed control, position control and torque control
·Power must be turned on again upon changes to the user parameter so as to effect the setting.
* POT and NOT signals may freely distribute inputted connector pin numbers by user parameters. See the Signal Distribution of Input Circuit for details.

(3) Motor stop method when using overtravel

Methods used to stop operation of motor when inputting overtravel signals (POT and NOT) during rotation of servo motor.

User Parameter	Methods for motor stop	After stop of motor	Meanings	
P□000	H.□0□□	Plug braking stopping	Inertial operation state	Reduce speed to stop the servo motor by emergency stop torque (P□407). Servo motor will be in inertial operation (de-energized) state after stop.
	H.□1□□	Inertial operation stopping		Stop the servo motor in the same manner as servo OFF (inertial operation stop). The servo motor will be in inertial operation (de-energized) state after stop.
	H.0□□□	Plug braking stopping	Inertial operation state	Reduce speed to stop the servo motor by emergency stop torque (P□407). Servo motor will be in inertial operation (de-energized) state after stop.
	H.1□□□	Plug braking stopping	Zero clamping state	Reduce speed to stop the servo motor by emergency stop torque (P□407). Servo motor will be in zero clamping (servo locking) state after stop.
	H.2□□□	Inertial operation stopping	Inertial operation state	Stop the servo motor in the same manner as servo OFF (inertial operation stop). The servo motor will be in inertial operation (de-energized) state after stop.

·Power must be turned on again upon changes to the user parameter so as to effect the setting.
·During setting of inertial operation for H.□1□□, the servo motor may be controlled if servo ON signals are received.
■ Words and expressions
·Inertial operation stopping: naturally stop the motor by friction resistance arising from motor rotation other than braking.

- Plug braking stopping: stop the motor via deceleration (brake) torque (P□407).
- Zero clamping state: use state of position loop in zero configuration of position reference.

* See the Selection of Stop Methods in Servo OFF for stop methods in servo OFF and alarm condition.

(4) Setting for stop torque in overtravel

P□407	Limit of plug braking torque			Speed	Position	Torque
	Setting range	Setting unit	Factory setting	Power reboot		
	0 ~ 300	1%	300	Not required		

- Set the stop torque used for inputting overtravel signals (POT and NOT).
- Setting unit corresponds to a percent (%) of the rated torque. (rated torque is 100%)
- The factory setting is 300% so that the setting is large enough a value to operate the servomotor at maximum torque. The maximum value of emergency stop torque that is actually available, however, is limited to the maximum torque of the servomotor.

5.3.4 Setting for Holding Brake

When the vertical shaft is driven by servo motor, it should be used. When power state of servo driver is OFF, use the servo motor with brake to prevent removable part from moving due to gravity. (Please refer to " Trial Operation for Servo Motor with Brake".)

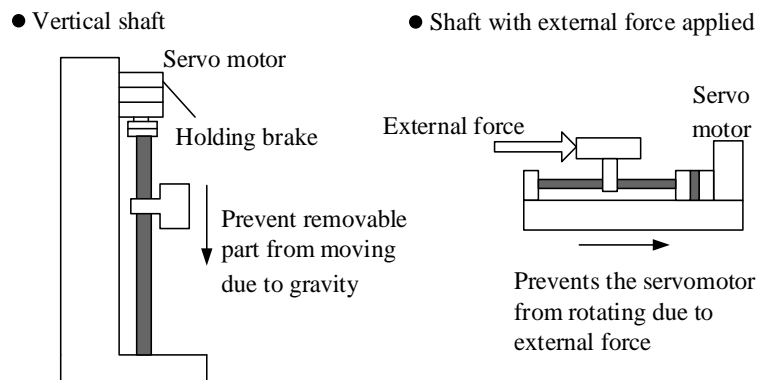

Note:

1. The brake built in the servo motor with brake should be a actuated-type holding brake without excitation, which cannot be used for braking. It should only be used to maintain the stop state of servo motor. Brake torque is over 120 % of rated torque of servo motor.
2. When operation of servo motor is enabled only by speed loop, servo and input reference should be set to OFF and "OV" respectively during operation of brake.
3. In configuration of position loop, mechanical brakes cannot move since servo is locking during servo motor's stop.

(1) Connection example

Order output signal "/BK" of servo driver and brake power constitute ON/OFF circuit of brake. Standard connection examples are as follows.

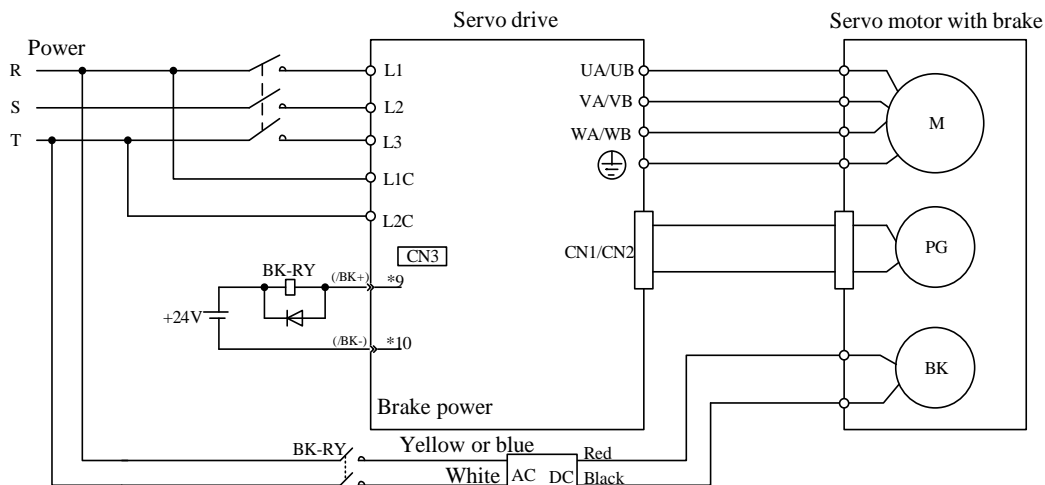

BK-RY: Brake control relay

9*、10*: Output terminal number, Assigned through the user parameter P□514.1

(2) Brake interlocking output

Name	Signal	Pin No. of connector (factory)		Set	Meanings
		A axis	B axis		
Output	/BK	Distribution through P□514		ON = L Level OFF = H Level	Release brake. Use brake.

When using servo motor with brake, it is the output signal of control brake. In addition, this output signal is not used in factory setting. Distribution for output signals is required (setting of P□514). Do not connect when using motor without brake.

(3) Distribution of brake signal (/BK)

Brake signals (/BK) cannot be used under the condition of factory setting. Therefore it is required to distribute output signals.

User Parameter	Pin No. of connector	Meanings
P□514	H.□□0□	Do not use /BK signals. (factory setting)
	H.□□1□	Output /BK signal through output terminal of OUT1(CN3-7, CN3-8).
	H.□□2□	Output /BK signal through output terminal of OUT2(CN3-9, CN3-10).
	H.□□3□	Output /BK signal through output terminal of OUT3(CN3-11, CN3-12).
	H.□□4□	Output /BK signal through output terminal of OUT4(CN3-32, CN3-33).
	H.□□5□	Output /BK signal through output terminal of OUT5(CN3-34, CN3-35).
	H.□□6□	Output /BK signal through output terminal of OUT6(CN3-36, CN3-37).

■Attentions
Brake signals (/BK) set in factory delivery are invalid. When several signals are distributed to the same output terminal, OR logic should be used for output. If you only want to enable /BK signal output, please distribute other signals of output terminal for /BK signal distribution to other output terminals or set them as invalid. See the Signal Distribution of Output Circuit for distribution methods of other output signals of servo unit.

(4) Timing setting of brake ON (after stop of servo motor)

During factory setting, /BK signals should be output while /S-ON signals are set as OFF (servo OFF), however, timing of servo OFF can be changed by user parameters.

P□506	Brake command - delay time for servo OFF			Speed	Positon	Torque
	Setting range	Setting unit	Factory setting	Power reboot		
	0 ~ 500	10ms	0	Not required		
<ul style="list-style-type: none"> When used in vertical shaft, removable parts of machinery may move slightly due to gravity or external force with timing of brake ON. Such slight movement can be eliminated by servo OFF operation delay via this user parameter. This parameter changes the brake ON timing while the servomotor is stopped. See the Timing Setting of Brake ON (after Stop of Servo Motor) for brake operation during rotation of servo motor. 						
<p>■ Attentions</p> <p>In case of alarm, servo motor will come into de-energized state immediately, which is unrelated to setting of user parameter.</p> <p>Machinery may move within period before brake operation due to gravity of removable parts of machinery or external force.</p>						

(5) Timing setting of brake ON (during rotation of servo motor)

If an alarm occurs while the servomotor is rotating, the servomotor will come to a stop and the brake signal will be turned OFF. The timing of brake signal output can be adjusted by setting the following parameter.

P□507	Brake Reference Output Speed Level			Speed	Position	Torque
	Setting range	Setting unit	Factory setting	Power reboot		
	0 ~ 6000	1r/min	100	Not required		
P□508	Servo OFF - waiting time of brake command			Speed	Position	Torque
	Setting range	Setting unit	Factory setting	Power reboot		
	10 ~ 100	10ms	50	Not required		
<p>Output conditions for /BK signals during rotation of servo motor. BK signals should be set as H level (brake initiates) if any of the following condition is met:</p> <ul style="list-style-type: none"> • RPM of motor is lower than P□507 after servo OFF • Setting time for P□508 is exceeded after servo OFF 						
<p>■Attentions</p> <ul style="list-style-type: none"> • Even P□507 is set as a value higher than maximum RPM of used servo motor, operation of the motor will also be limited by its maximum RPM. • Distribute motor rotation detection signal (/TGON) and brake signal (/BK) to other terminals. • When brake signal (/BK) and motor rotation detection signal (/TGON) are distributed to the same output terminal, /TGON signal is changed to L level due to falling speed in the vertical shaft. Even conditions for the user parameter are met, /BK signal may also cannot be changed to H level. (Since output is completed by OR logic when several output signals are distributed to the same output terminal) Refer to "Signal Distribution of Output Circuit" for details of distribution of output signals. 						

5.3.5 Selection of Stop Methods in Servo OFF

Select stop methods for servo unit in servo off.

User Parameter		Methods for motor stop	After stop of motor	Meanings
P□000	H.□0□□	Plug braking stopping	Inertial operation state	Reduce speed to stop the servo motor by emergency stop torque (P□407). Servo motor will be in inertial operation (de-energized) state after stop.
	H.□1□□	Inertial operation stopping		Stop the servo motor in the same manner as servo OFF (inertial operation stop). The servo motor will be in inertial operation (de-energized) state after stop.

Setting of user parameter is valid under the following conditions:

- /S-ON output signal OFF (servo OFF)
- Main power (L1, L2 and L3) OFF

■Words and expressions

- Plug braking stopping: stop the motor via deceleration (brake) torque (P□407).
- Inertial operation stopping: naturally stop the motor by friction resistance arising from motor rotation other than braking.

■Attentions

- When power of main circuit (L1, L2 and L3) or control power supply (L1C and L2C) is OFF, the following servo drivers will force to execute plug braking stop despite of the above setting of user parameter.
- In case of alarm from servo driver, the servo driver will execute inertial stop.

5.4 Use of Absolute Encoder

If a servo motor with absolute encoder is used, absolute value detection system can be configured in the command controller (host system). Results indicate that it can operate again directly without need of origin reset when power is ON again.

Resolution of absolute encoder	Output range of multi-turn data	Operation when exceeding limit
17 digit (*131072 pulse/circle)	-32768 ~ +32767	When upper limit value (+32767) for positive direction is exceeded, multi-turn data is changed to -32768 When upper limit value (-32768) for negative direction is exceeded, multi-turn data is changed to +32767

5.4.1 Interface Circuit

Standard connection of absolute encoder installed in the servo motor is as follows:

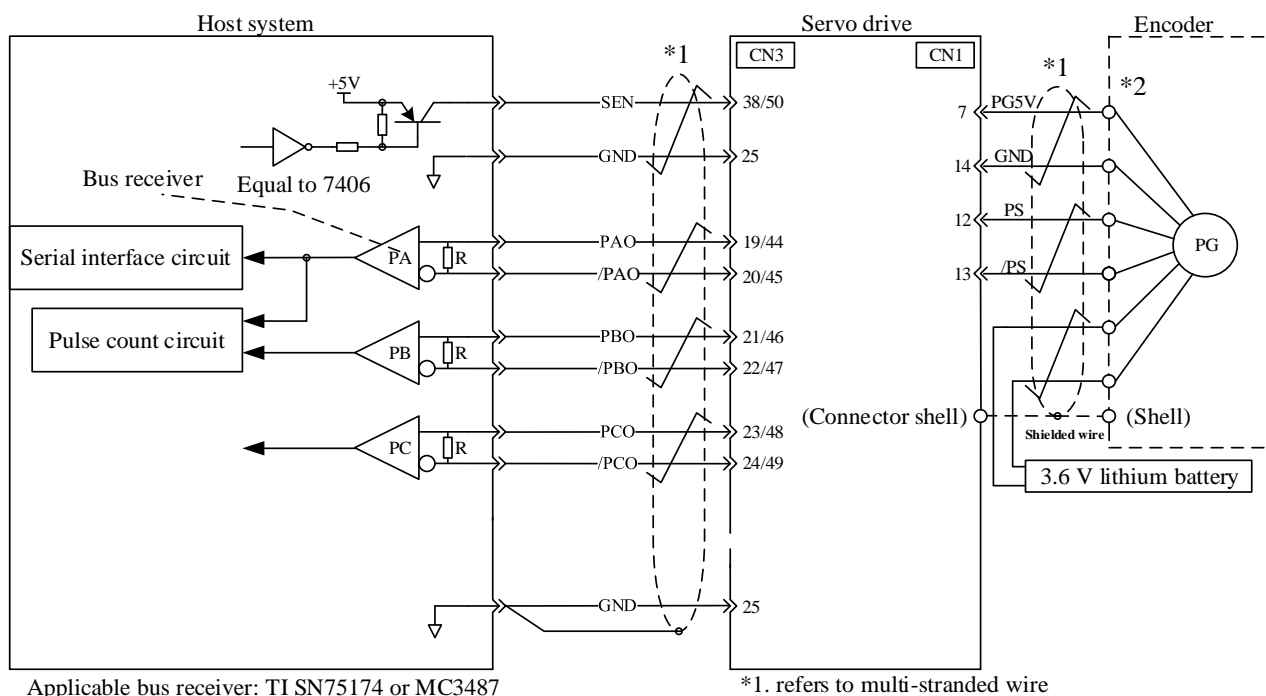

■ Connection of SEN signal

Name	Signal	Pin No. of connector	Set	Meanings
Input	ASEN	CN3-38	FF = L level	When power is supplied
			ON = H level	Absolute value is required
Input	BSEN	CN3-50	FF= L level	When power is supplied
			ON = H level	Absolute value is required

This input signal must be used to reference the servo driver to output absolute data. Please set the SEN signal as H level after the power is connected for 3 seconds.

If SEN signal is switched between L level and H level, then multi-turn data and initial incremental pulse should be output.

Before completion of these operations, the servo motor will not be energized even if servo ON signal (/S-ON) is in ON state. Operation panel displays "OFF".

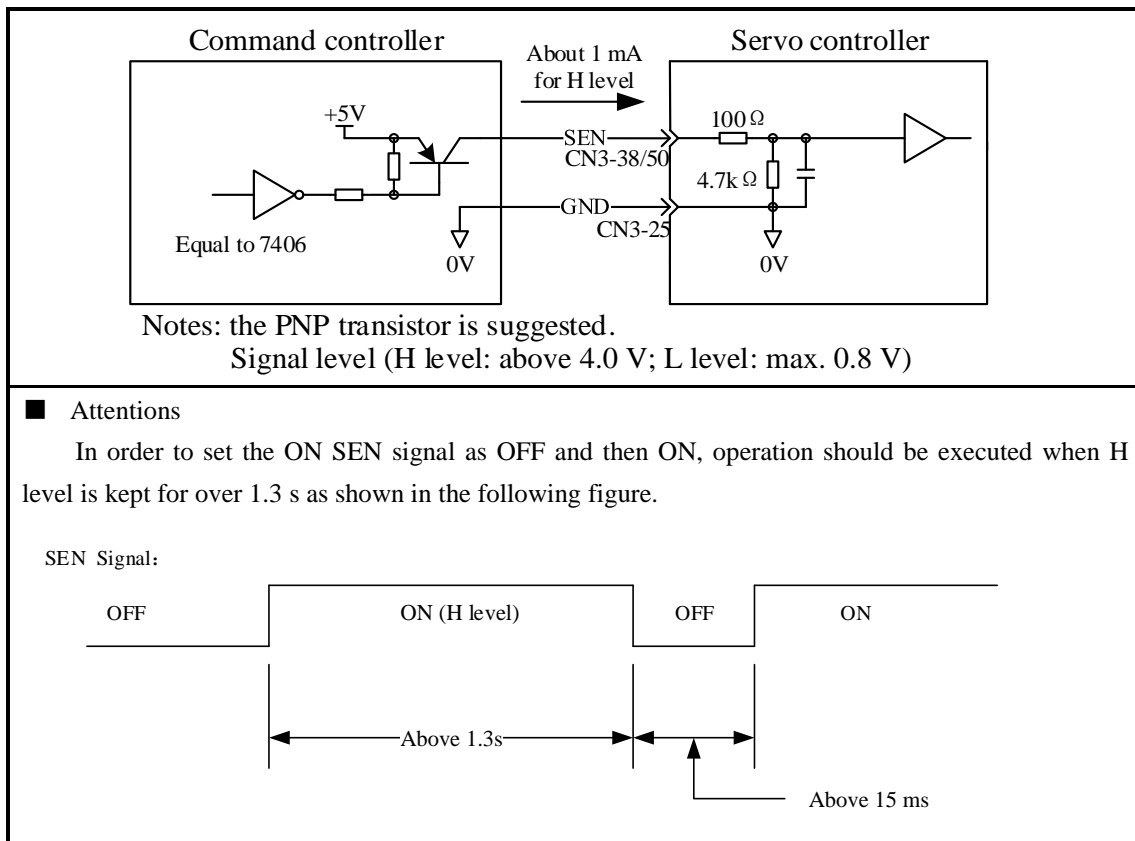

5.4.2 Selection of Absolute Encoder

Absolute encoder can also be used as incremental encoder.

User Parameter		Meanings
P□001	n.□□□0	Use absolute encoder as absolute encoder and enable serial output of absolute data (PG frequency dividing PAO □)
	n.□□□1	Use absolute encoder as incremental encoder
	n.□□□2	Use absolute encoder as absolute encoder and prevent serial output of absolute data (PG frequency dividing PAO □)
<ul style="list-style-type: none"> ● As an incremental encoder, SEN signal and battery is not required ● Power must be turned on again upon changes to the user parameter so as to effect the setting. 		

5.4.3 How to Use Battery

Recommended battery specification: ER36V

■ Procedures for battery replacement

1. Please replace batteries when control power of servo unit is ON;
2. After batteries are replaced, use auxiliary function F□010 to remove alarm of absolute encoder so as to stop alarm of absolute encoder battery.
3. If no abnormal operation is found after restart of servo driver power, it indicates that replacement of battery is over

Attentions:

Data of absolute encoder will be lost if control power of servo driver is set as OFF and wires(including encoder cables) of battery is removed. At this time, setting operation for absolute encoder must be carried out. Please refer to "2.3.4 Setting of Absolute Encoder (F□009)"

5.4.4 Giving and Receiving Sequence of Absolute Data

After receipt of output from absolute encoder, the sequence used for the driver to send absolute data to the command controller is as follows.

(1) Summary of absolute signal

As shown below, serial data and pulse of absolute encoder are output by servo driver via "PAO, PBO and PCO".

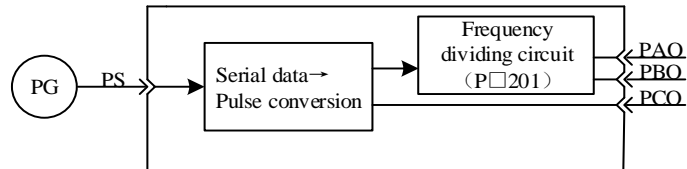

Signal	State	Signal content
PAO	At initialization	Serial data Initial incremental pulse
	Normal time	Incremental pulse
PBO	At initialization	Initial incremental pulse
	Normal time	Incremental pulse
PCO	Always	Origin pulse

(2) Sending sequence and content of absolute data

- 1、 Set SEN signal as H level
- 2、 After 100 ms, wait state for serial data acceptance starts. Reversible counters used for incremental pulse count should be reset.
- 3、 Receive serial data in 8 bytes
- 4、 It will change to common incremental operation state after last serial data is received for 25 ms.

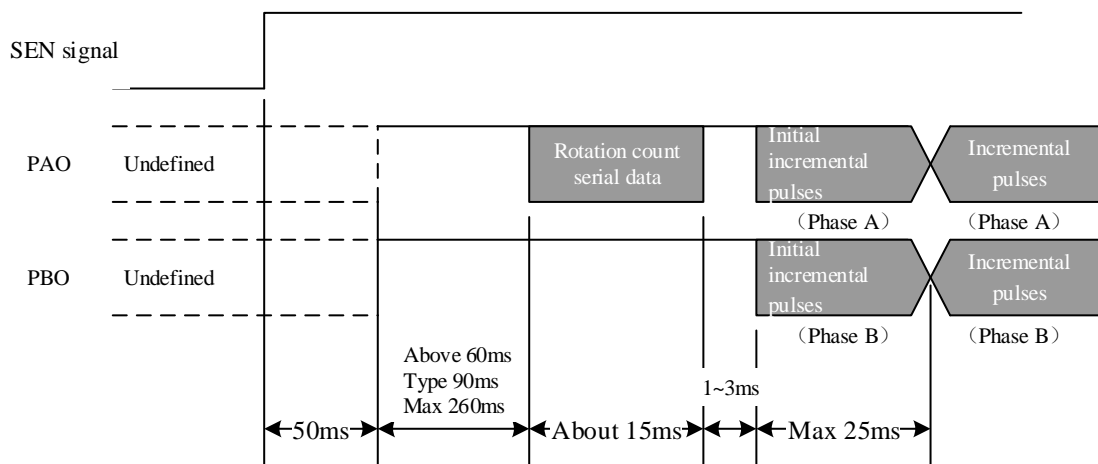

* Serial data

It indicates position of motor shaft after circuits of rotation from the reference position (as per setting value)

* Initial incremental pulse

Pulse should be output at the same speed as pulse for rotation of 1250rpm (factory setting is used for 17 byte frequency dividing pulse).

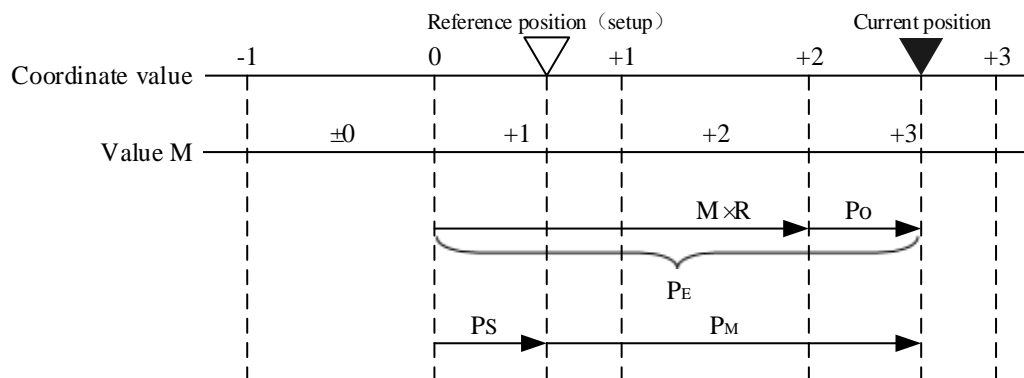

Final absolute data P_M can be calculated by the following formula:

$$P_E = M \times R + P_0$$

$$P_M = P_E - P_S$$

Notes: the following formula is used in negative rotation mode ($P_n000.0 = 1$)

$$P_E = -M \times R + P_0$$

$$P_M = P_E - P_S$$

P_E	Current value read from encoder
M	Multi-turn data (number of turns of encoder)
P_0	Count of initial incremental pulse
P_S	Count of initial incremental pulse read from the set point (this value is subject to storage and management of host)
P_M	Current value required in client system
R	Pulse count for 1 circle of rotating encoder (value after frequency dividing and value of $P_{□201}$)

(3) Detailed specification of signal

(a) Specification of PAO serial data

Output rotation in 5 digits

Data transmission method	Start-stop synchronism (ASYNC)
Baud rate	9600 bps
Start bit	1 bit
Stop bit	1 bit
Parity	Even parity check
Character code	ASCII 7-bits coder
Data format	See the following figure for data in 5 characters.

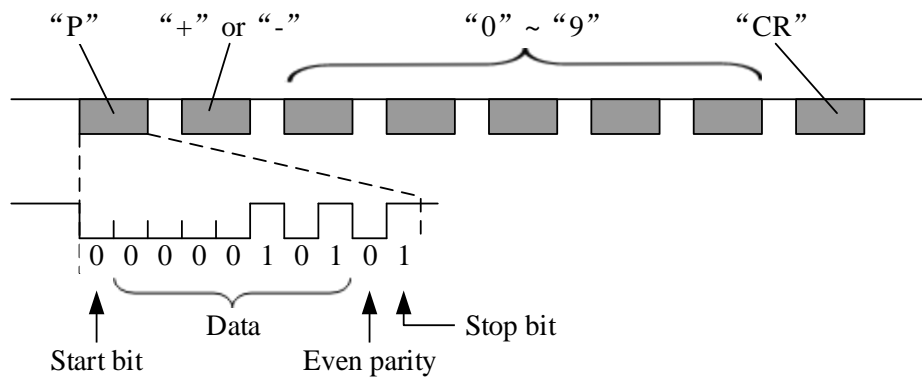

Note:

- 1, Data is "P+00000" (CR) or "P-00000" (CR) when the number of revolutions is zero.
- 2, The revolution range is "+32767" to "-32768". When this range is exceeded, the data changes from "+32767" to "-32768" or from "-32768" to "+32767".

5.4.5 Setting of Absolute Encoder (F□009/ F□010)

In addition, setting operation for absolute encoder must be carried out in case of:

- * initial startup of machinery
- * "Bus encoder multi-coil information error (A25 / b25)"
- * "Bus encoder multi-coil information overflow (A26 / b26)"
- * "Bus encoder battery alarm 1 (A27 / b27)"
- * requiring to set multi-turn data of absolute encoder as 0

Implement setting by panel operator.









Attentions:

- 1、 Setting operation of encoder only can be implemented under servo OFF state.
- 2、 When absolute encoder alarm is displayed, auxiliary function F□010 should be executed to stop alarm. Alarm reset (/ALM-RST) of servo driver cannot stop alarm.
 - * "Bus encoder multi-coil information error (A25 / b25)
 - * Bus encoder multi-coil information overflow (A26 / b26)
 - * Bus encoder battery alarm 1 (A27 / b27)
 - * Bus encoder battery alarm 2 (A28 / b28)
 - * Bus encoder overspeed (A41 / b41)

5.4.6 Clear of Multi-coil Data of Absolute Encoder









When using bus absolute encoder, the operation can be used to remove multi-coil information.

Operation steps	Operation instruction	Operation key	Display after operation
1	Press M function key (for more than 1 second) and switch to auxiliary function mode of axis 1, which will display FA000.	M	FA000

2	Press UP or DOWN and select the desired auxiliary function FA010.		
3	Press SET to display "PoSCL" and clear multi-coil position operation.		
4	Press function key to display "CLFIn" which indicates that multi-coil position is completely cleared.		
5	Press SET to return to the display of FA009.		

5.4.7 Clear of Internal Errors of Bus Encoder

When using bus absolute encoder, the operation can be used to remove multi-coil information.

Operation steps	Operation instruction	Operation key	Display after operation
1	Press M function key to select auxiliary function mode for A axis. In case of failing to display FA010 press UP or DOWN to set FA010.		
2	Press SET to display "ErrCL".		
3	Press M function key to display "CLFIn" and clear encoder multi-coil information completely.		
4	Press SET to return to the display of FA009.		

5.5 Speed Control (Analog Voltage Reference) Operation

5.5.1 User Parameter Setting

User Parameter		Meanings
P□000	H.□□0□	Selection of control mode: speed control (analog voltage reference)

P□300	Speed command input gain			Speed	Position	Torque
	Setting range	Setting Unit	Factory setting	Power reboot		
	0 ~ 3000	(r/min) /V	150	Not required		

■ For example,
 P□300=150: 1 V voltage corresponds to inputting 150r/min (factory setting)
 P□300=300: 1 V voltage corresponds to inputting 300r/min (factory setting)

5.5.2 Setting of Input Signal

(1) Speed reference input

If speed reference is sent to servo driver in the form of analog voltage reference, speed of servo motor is controlled in proportion to input speed.

Name	Signal	Pin No. of connector (factory)		Meanings
		A axis	B axis	
Input	V-REF	CN3-5	CN3-30	Speed reference input
	GND	CN3-6	CN3-31	Signal ground for speed reference input

It should be used for speed control (analog voltage reference) (P□000.1 = 0, 4, 7, 9, A)
 P□300 is used to set speed reference input gain. Please refer to "Setting of User Parameter for details".

■ Input specification

- Input voltage range: DC ±10V
- Maximum allowable input voltage: DC ±12V

(2) Proportional action reference signal (/P-CON)

Name	Signal	Pin No. of connector (factory)		Set	Meanings
		A axis	B axis		
Input	/P-CON	CN3-15	CN3-40	ON = L Level	Operate servo driver by P control mode.
				OFF = H Level	Operate servo driver by PI control mode.

/P-CON signal is a signal that selects speed control modes from PI (proportional and integral) or P (proportional) control. If P control is set, motor rotation and slight vibration arising from input shift of speed reference can be reduced. Input reference: servo motor rotation due to 0 V shift can be reduced, but servo rigidity (support force) will decrease when rotation is stopped.
 /P-CON signals may distribute inputted connector pin numbers to other places by user parameters. Please refer to "Signal Distribution of Input Circuit".

5.5.3 Adjustment of Reference Offset

In speed control mode, even if OV reference is sent under analog reference voltage, motor will rotate with low speed in case of small reference voltage offset (unit: mV) of superior control unit or in external circuit. In such case, reference offset can be automatically or manually adjusted by panel operator. See "5.2 Operation in Auxiliary Function Execution Mode" for details.

Auto-adjustment of analog (speed ·torque) or reference offset is the function for offset measurement and auto-adjustment of voltage.

In case of voltage reference offset of the superior controller or in external circuit, servo driver will make following adjustment towards the automatic offset.

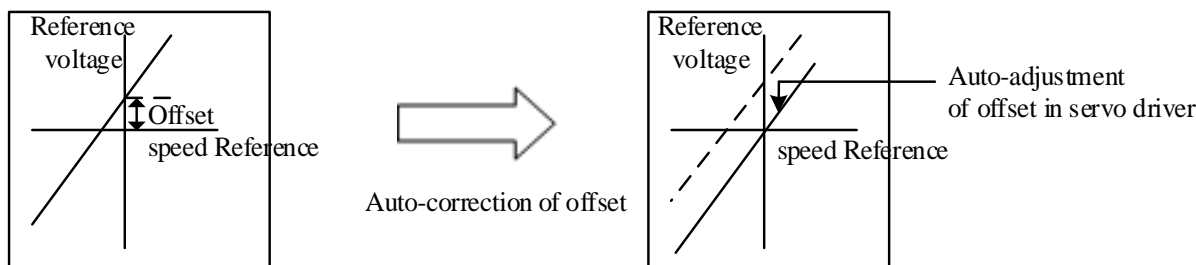

Once auto-adjustment of reference offset begins, offset will be saved in the servo driver.

Offset can be confirmed through manual adjustment of speed reference offset (F□006). See "5.5.3(2) Manual adjustment of speed reference offset" for details.

(1) Auto-adjustment of speed reference offset

When offset pulse is set as zero with the servo locked in the OFF state by the command controller equipped with a position loop, auto-adjustment of reference offset (F□008) is not available, instead, manual adjustment of speed reference offset (F□00A) should be applied.

Under speed reference of zero, function of zero clamping speed control which can lock the servo in a mandatory manner is provided. See "5.5.6 Use of Zero Clamping Function" for details.

Note: Auto-adjustment of zero analog offset should be conducted when the servo is OFF.

Auto-adjustment of speed reference offset of A axis is conducted as below.

Operation steps	Operation instruction	Operation key	Display after operation
1			Set the servo unit as OFF, and input 0V reference voltage through reference controller or external circuit.
2	Press M function key to select auxiliary function mode for A axis. In case of failing to display FA008, press UP or DOWN to set.	M	
3	Press SET, and "rEF_o" is displayed.	SET	
4	Press M function key to start auto-zeroing, and flickering "donE" is displayed.	M	
5	After completion of auto-zeroing, "rEF_o" instead of flickering "donE" is displayed.	—	
6	Press SET to return to the display of FA008.	SET	

(2) Manual adjustment of speed reference offset

Manual adjustment of speed reference offset (F□006) should be applied in case that:

- the reference controller is equipped with a position loop to set the offset pulse as zero when the servo is locked in the OFF state
- offset is set as a certain value consciously
- offset set for auto-adjustment is applied

Basic function and auto-adjustment of analog (speed ·torque) reference offset (F□008) are the same. But for manual adjustment (F□006), adjustment must be made along with direct input of offset.

Adjustment range of offset and setting unit are listed as below.

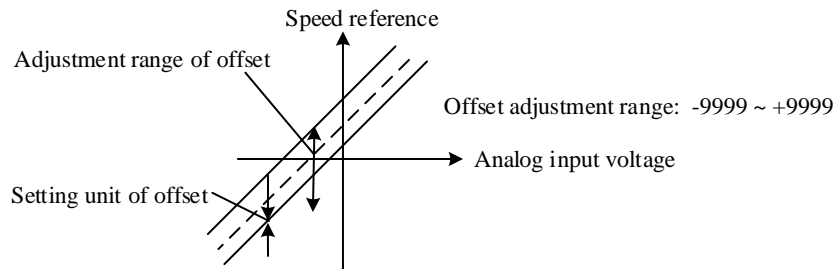

Auto-adjustment of speed reference offset of A axis is conducted as below.

Operation steps	Operation instruction	Operation key	Display after operation
1	Press M function key to select auxiliary function mode for A axis. In case of failing to display FA006, press UP or DOWN to set.	M	FA006
2	Press SET, and "A.SPd" is displayed.	SET	A SPd
3	Press SET for at least 1 s, and "0000" is displayed.	<	0000
4	Press UP or DOWN to set offset.	^ v	0083
5	Press SET for at least 1 s to save offset.	<	A SPd
6	Press SET to return to the display of FA006.	SET	FA006

5.5.4 Soft Start

Soft start is the function to transfer step speed reference input to the reference with certain acceleration and deceleration in the servo driver.

(1) Trapezoidal start-up

User Parameter	Meanings
P□309	H.□□□0 Trapezoidal start-up

P□305	Acceleration time of soft start			Speed
	Setting range	Setting unit	Factory setting	Power reboot
	0 ~ 10000	1ms	0	Not required
P□306	Deceleration time of soft start			Speed
	Setting range	Setting unit	Factory setting	Power reboot
	0 ~ 10000	1ms	0	Not required

While inputting step speed reference or selecting internal speed setting, smooth speed control is available. (set "0" for common speed control.)
 Setting values are listed as below.
 ·P□305: time required from the OFF state to the speed of 1000r/min
 ·P□306: time required from the speed of 1000r/min to the OFF state

(2) S-curved start-up

User Parameter		Meanings
P□309	H. □□□1	S-curved start-up
	H. □0□□	Close to linearity
	H. □1□□	Low
	H. □2□□	Central
	H. □3□□	Height
		Selection of S curve ratio

P□308	Rise time of S curve			Speed
	Setting range	Setting unit	Factory setting	Power reboot
	0 ~ 10000	1ms	0	Not required

(3) Acceleration and deceleration filtering start-up

User Parameter		Meanings
P□309	H. □□□2	Acceleration and deceleration filtering start-up
	H. □□0□	First acceleration and deceleration filtering
	H. □□1□	Second acceleration and deceleration filtering

P□307	Time parameter of speed reference filter		Speed	
	Setting range	Setting unit	Factory setting	Power reboot
	0 ~ 10000	1ms	0	Not required

Smooth speed reference through acceleration and deceleration filter.
A overlarge value set will reduce responsiveness.

5.5.5 Use of Zero Clamping Function

(1) Meaning of zero clamping function

Zero clamping function refers to the function in the system where command controller is not equipped with position loops under speed control.

If the zero clamping (/P-CON) signal is set as ON, servo driver will be equipped with a position loop, and servo motor will fall into emergency stop with servo in the locked state regardless of speed reference when input voltage of speed reference (V-REF) is lower than the value corresponding to the rotation speed of P□501 (zero clamping level).

Servo motor is clamped within ± 1 pulse at the position where zero clamping takes effect. Even through external rotation, the servo motor will return to zero clamping.

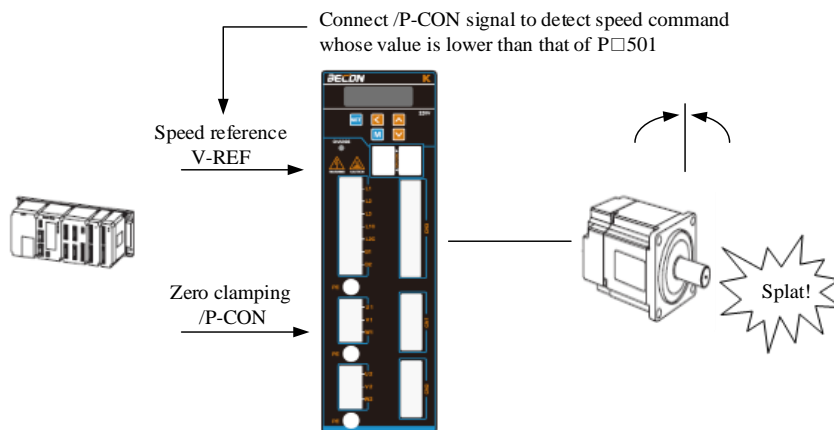

User Parameter	Meanings
P□000	H.□□A□ Control mode: speed control (analog voltage reference) \leftrightarrow zero clamping
Condition for switching of zero clamping action	
When P□000 is set as H.□□A□, zero clamping will be activated in case of any of the followings:	
·/P-CON is ON (L level)	
·Speed reference (V-REF) is lower than the setting value of P□501	

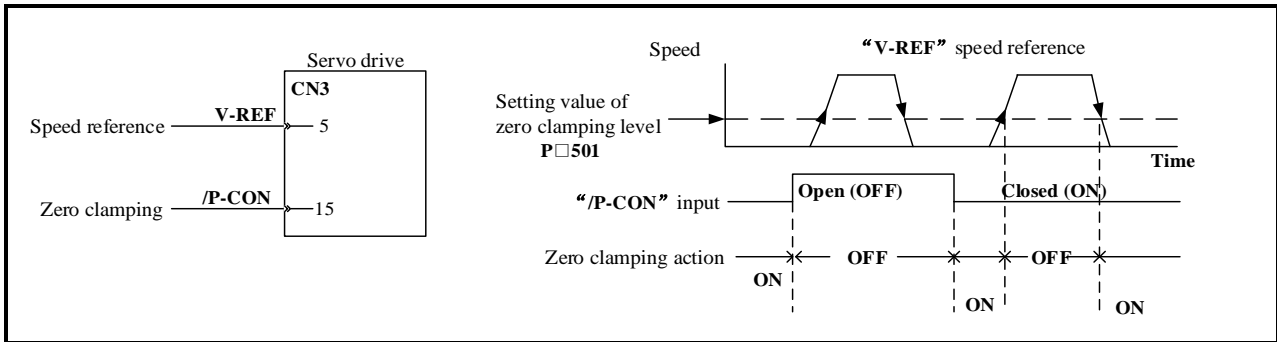

P□501	Zero clamping level			Speed
	Setting range	Setting unit	Factory setting	Power reboot
	0 ~ 10000	1r/min	10	Not required

When speed control with zero clamping function(P□000=H.□□□A□) is selected, rotation speed to activate zero clamping should be set. Even if the value of P□501 exceeds the maximum rotation speed of the servo motor, maximum rotation speed of servo motor still adopts valid value.

(3) Setting of input signal

Name	Signal	Pin No. of connector (factory)		Set	Meanings
		A axis	B axis		
Input	/P-CON	CN3-15	CN3-40	ON = L Level	Zero clamping function ON (valid)
				OFF = H Level	Zero clamping function OFF (invalid)

It is the input signal to switch to zero clamping action.
 Anyone of /P-CON signal can be switched to zero clamping action.
 See "signal distribution of input circuit" for distribution

5.5.6 Encoder Signal Output

Feedback pulse of encoder is output after processing in servo unit.

Name	Signal	Pin No. of connector		Name
		A axis	B axis	
Output	APAO+	CN3-19	CN3-44	Encoder output Phase A+
	APAO-	CN3-20	CN3-45	Encoder output Phase A-
Output	APBO+	CN3-21	CN3-46	Encoder output Phase B+
	APBO-	CN3-22	CN3-47	Encoder output Phase B-
Output	APCO+	CN3-23	CN3-48	Encoder output Phase C+
	APCO-	CN3-24	CN3-49	Encoder output Phase C-
Input	SEN	CN3-38	CN3-50	SEN signal input (valid when using absolute encoder)
	GND	CN3-25		Signal ground

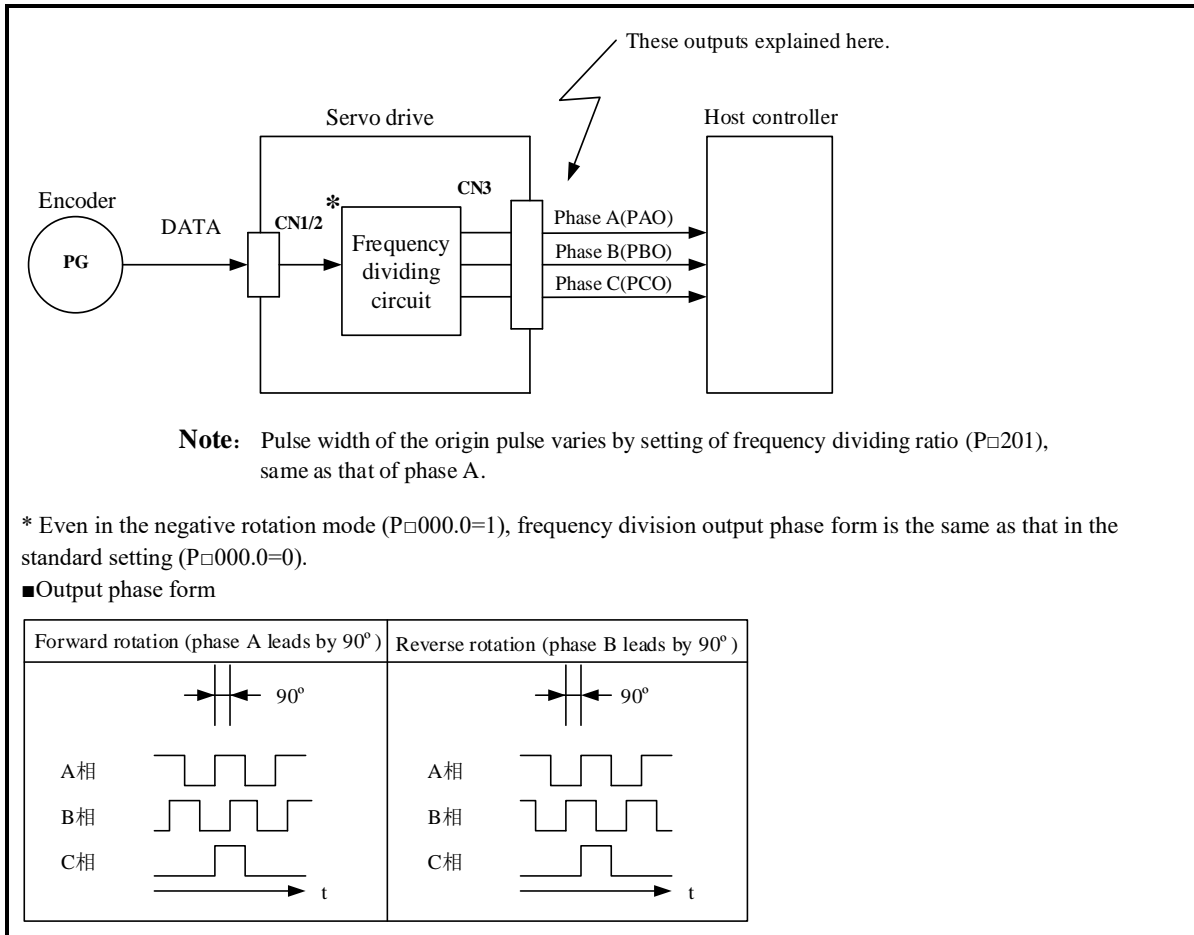

Note:

For bus encoder, C-phase pulse output of servo driver should be applied for mechanical origin reset after two cycles of rotation of servo motor.

·Setting of frequency dividing ratio of encoder pulse

P□201	PG frequency dividing		Speed	Position	Torque
	Setting range	Setting unit	Factory setting	Power reboot	
	16 ~ 32768	1P/rev	2500	Required	

Set output pulse of PG output signal (PAO,PBO) sent from servo driver.
Frequency of each cycle of feedback pulse from encoder is divided into the setting value of P□201 in the servo driver and output. (setting based on system specification of machinery and reference controller.)

■Output example
P□201=16 (16 pulse output in each cycle)

Setting value: 16

PAO

PBO

1 cycle

5.5.7 Same Speed Detection Output

Name	Signal	Pin No. of connector (factory)		Set	Meanings
		A axis	B axis		
Output	/V-CMP	CN3-9	CN3-34	ON = L Level	State of same speed
		CN3-10	CN3-35	OFF = H Level	State of different speed

The output signal can be distributed to other output terminals through user parameter P□513.
See "Signal distribution of output circuit" for distribution of output signal.

5.6 Position Control Operation

5.6.1 User Parameter Setting





Following user parameters should be set for position control by pulse train.

(1) Control mode selection

User Parameter	Meanings
P□000	H.□□1□ Control mode selection: position control (pulse train reference)

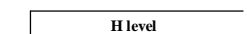
Name	Signal	Pin No. of connector		Name
		A axis	B axis	
Input	PULS+	CN3-1	CN3-26	Reference pulse input
	PULS-	CN3-2	CN3-27	Reference pulse input
	SIGN+	CN3-3	CN3-28	Sign input
	SIGN-	CN3-4	CN3-29	Sign input

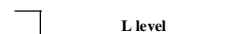
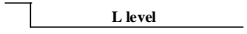
(2) Selection of pulse reference form

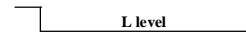
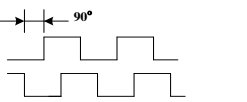
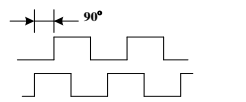
User Parameter	Reference form	Input multiple	Positive rotation reference	Negative rotation reference	
P□200	H.□□0□	Sign + pulse train	PULS  SIGN  H level	PULS  SIGN  L level	
	H.□□1□	CW+CCW	PULS  L level SIGN 	PULS  SIGN  L level	
	H.□□2□	Two phase pulse train with 90° phase difference	×1		
	H.□□3□		×2		
H.□□4□	×4				

■Supplement

Input multiplication can be set in the state of 90 phase difference under two phase pulse reference.

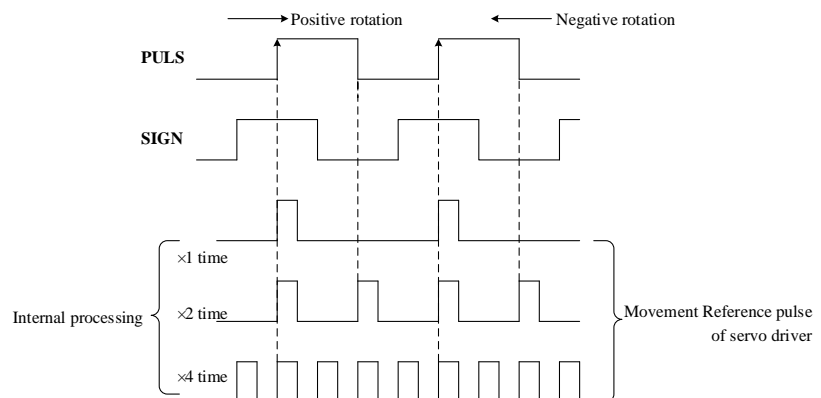

(3) Pulse instruction input complement

User Parameter	Meanings
P□200	H.□0□□ PULS input reverse, and SIGN input does not reverse
	H.□1□□ PULS input does not reverse and SIGN input reverse

	H.□2□□	PULS input reverse, and SIGN input does not reverse
	H.□3□□	PULS input reverse, and SIGN input does not reverse
Logic reverse for pulse reference is available by setting the parameter.		

(4) Selection of clear signal form

Name	Signal	Pin No. of connector (factory)		Name
		A axis	B axis	
Input	/CLR	Distribution through P□510		Clear input

If input is cleared, following actions can be performed.

- Offset counter in the servo driver is set as "0".
- Action of position loop is set in the invalid state.
 - In clear state, servo clamping does not work, and servo motor may rotate with a low speed due to drifting in the speed loop.

(5) Selection of clear action

In the condition other than clear signal CLR, regular clear of offset pulse can be selected based on state of servo driver. Three types of action mode of clear offset pulse can be selected through user parameter P□200.0.

User Parameter	Meanings	
P□200	H.□□□0	Under servo OFF, clear offset pulse; under over travel, not clear offset pulse
	H.□□□1	Under servo OFF or over travel, not clear offset pulse
	H.□□□2	Under servo OFF or over travel (excluding zero clamping), not clear offset pulse

5.6.2 Setting of Electronic Gear

(1) Encoder pulse

Encoder type	Encoder pulse	
Common incremental encoder	2500 P/R	
Bus encoder	17 bits	32768 P/R

Note: Bits representing encoder resolution are different from pulse of signal output of encoder (phase A and phase B), and are four times of encoder pulse.

(2) Electronic gear

Electronic gear is the function to set any value for movement of workpiece with 1 pulse input reference by command controller. 1 pulse reference by command controller is "1 reference unit" as the smallest unit.

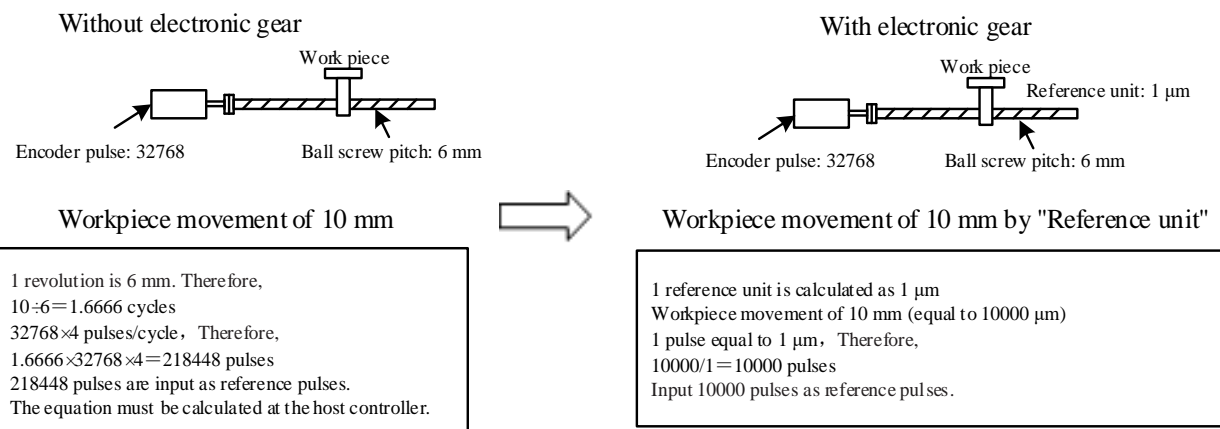

(3) Relevant user parameter

P□202	Electronic gear (numerator)			Position
	Setting range	Setting unit	Factory setting	Power reboot
	1 ~ 65535	—	1	Required
P□508	Electronic gear (denominator)			Position
	Setting range	Setting unit	Factory setting	Power reboot
	1 ~ 65535	—	1	Required
<p>If the deceleration ratio of the motor and the load shaft is given as n/m. Setting value of electronic gear ratio can be calculated by formula below.(M is the rotation of the motor and n is the rotation of the load shaft)</p> $\text{Electronic gear ratio: } \frac{B}{A} = \frac{P□202}{P□203} = \frac{\text{Encoder pulse} \times 4}{\text{Movement of loading axis with 1 cycle of rotation}} \times \frac{m}{n}$ <p>* In case of beyond the setting range, numerator and denominator should be reduced to the integer within the setting range. Note: electronic gear ratio (B/A) should not be changed.</p> <p>■Attentions Setting range of electronic gear ratio: $0.01 \leq \text{electronic gear ratio (B/A)} \leq 100$ In case of beyond the range, servo driver cannot work normally. In such case, mechanical structure or command unit should be changed.</p>				

(4) Procedure for setting the electronic gear ratio

Electronic gear ratio should be set as below.

Step	Content	Instruction
1	To confirm mechanical specifications	Reduction ratio, ball screw pitch, pulley diameter, etc. should be confirmed.
2	To confirm encoder pulse	Encoder pulse of servo motor should be confirmed.
3	To determine reference unit	1 reference unit by command controller should be determined. Reference unit should be determined based on mechanical specifications and positioning accuracy.
4	To calculate movement of loading axis with 1 cycle of rotation	Reference units for 1 cycle of loading axis should be calculated based on determinate reference unit.
5	To calculate electronic gear ratio	Electronic gear ratio (B/A) should be calculated according to the related formula.
6	To set user parameter	The value calculated should be set as electronic gear ratio.

(5) Example for setting of electronic gear ratio

Electronic gear ratio is determined based on several examples.

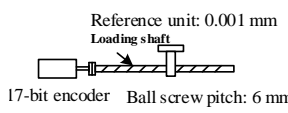
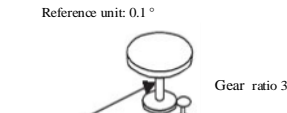
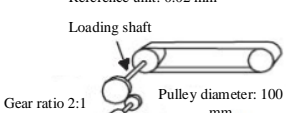
Step	Content	Load configuration		
		Ball screw	Disc table	Belt + pulley
		Reference unit: 0.001 mm  17-bit encoder Ball screw pitch: 6 mm	Reference unit: 0.1 °  Loading shaft Gear ratio 3:1 17-bit encoder	Reference unit: 0.02 mm  Loading shaft Gear ratio 2:1 Pulley diameter: 100 mm 17-bit encoder
1	Check mechanical structure	<ul style="list-style-type: none"> Ball screw pitch: 6 mm Gear ratio: 1/1 	Rotation angle of 1 cycle: 360 ° Gear ratio: 3/1	Pulley diameter: 100 mm (Pulley perimeter: 341 mm) Gear ratio: 2/1
2	Encoder	17-bit: 32768P/R	17-bit: 32768P/R	17-bit: 32768P/R
3	Determine the reference unit used.	1 reference unit: 0.001 mm (1 μm)	1 reference unit: 0.1 °	1 reference unit: 0.02mm

4	Calculate movement of loading axis with 1 cycle of rotation	6mm/0.001mm=6000		360 %0.1 ≈3600		314 mm/0.02 mm=15700	
5	Calculate the electronic gear ratio	$\frac{B}{A} = \frac{32768 \times 4}{6000} \times \frac{1}{1}$		$\frac{B}{A} = \frac{32768 \times 4}{3600} \times \frac{3}{1}$		$\frac{B}{A} = \frac{32768 \times 4}{15700} \times \frac{2}{1}$	
6	Set user parameter	P□202	131072 *	P□202	393216	P□202	262144
		P□203	6000	P□203	3600	P□203	15700

* Calculation result is not within the setting range. Hence numerator and denominator are reduced.

For example, numerator and denominator are reduced by 4. As a result, P□202 = 32768 and P□203 = 1500. Then the setting is completed.

(6) Equation of electronic gear ratio

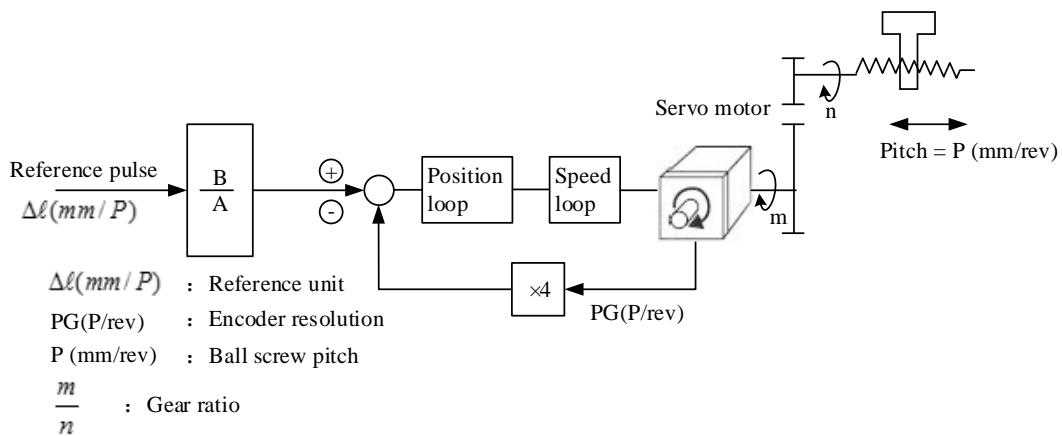

$$\frac{n \times p}{\Delta l} \times \left(\frac{B}{A}\right) = 4 \times PG \times m$$

$$\left(\frac{B}{A}\right) = \frac{4 \times PG \times m \times \Delta l}{n \times p} = \frac{4 \times PG}{P} \times \frac{m}{n}$$

A and B should be set through user parameter:

A : P□203 **B** : P□202

5.6.3 Position Reference

Position of servo motor is controlled by the reference in the form of pulse train. Pulse train output forms of command controller are listed as below.

- Bus driver output
- +24V collector open circuit output
- +12 V collector open circuit output
- +5 V collector open circuit output

Note:

Note for collector open circuit output: when pulse output is conducted through collector open circuit, noise margin of input signal will reduce. In case of offset caused by noise, following user parameters should be changed.

User Parameter		Meanings
P□200	H.1□□□	Reference input filtering for collector open-circuit signal

(1) Timing example for input/output signal

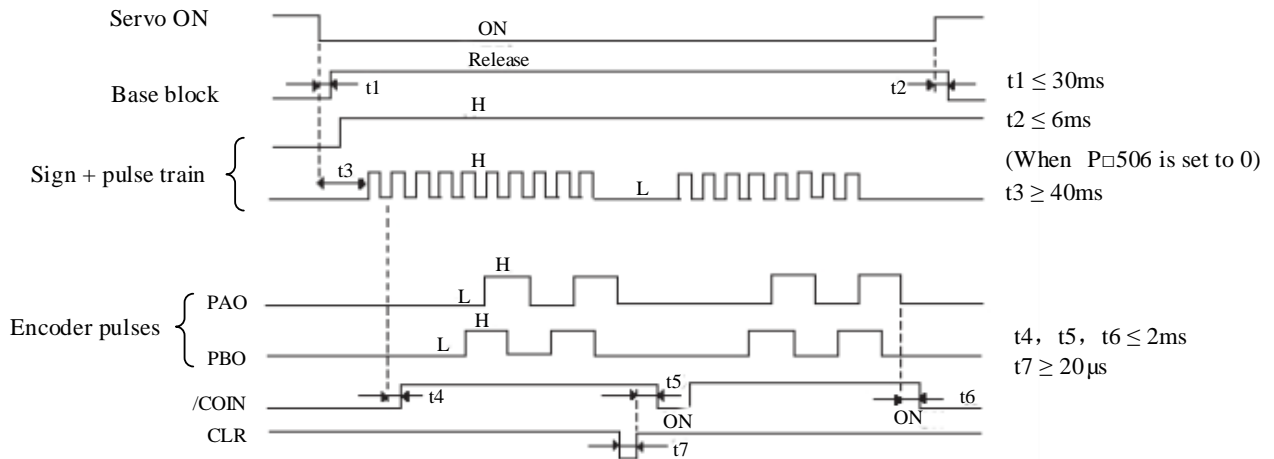

Note:

- Interval between ON set for servo ON signal to input of reference pulse should be more than 40 ms; Otherwise, the reference pulse may not be received by the servo driver.
- Clear signal ON should be set more than 200 μs.

Table: Timing for reference pulse input signal

Reference pulse form	Electrical specification	Remarks	
Sign + pulse train input (SIGN + PULS signal) Maximum reference frequency: 500 kpps (In case of open-collector output, maximum reference frequency: 200 kpps)		$t1, t2 \leq 0.1\mu s$ $t3, t7 \leq 0.1\mu s$ $t4, t5, t6 > 3\mu s$ $\tau \geq 1.0\mu s$ $(\tau/T) \times 100 \leq 50\%$	<p>SIGN H = Forward reference L = Reverse reference</p>
CW pulse + CCW pulse Maximum reference frequency: 500 kpps (In case of open-collector output, maximum reference frequency: 200 kpps)		$t1, t2 \leq 0.1\mu s$ $t3 > 3\mu s$ $\tau \geq 1.0\mu s$ $(\tau/T) \times 100 \leq 50\%$	
Two phase pulse with 90° phase difference (Phase A + Phase B) Maximum reference frequency: × 1multiplier: 500kpps × 2multiplier: 400kpps × 4multiplier: 200kpps		$t1, t2 \leq 0.1\mu s$ $\tau \geq 1.0\mu s$ $(\tau/T) \times 100 \leq 50\%$	<p>Multiplication mode can be setted through user parameter P□200.1.</p>

(2) Connection example

(a) Connection example of line driver output

Applicable line driver: equivalent of TI SN75174 or MC3487

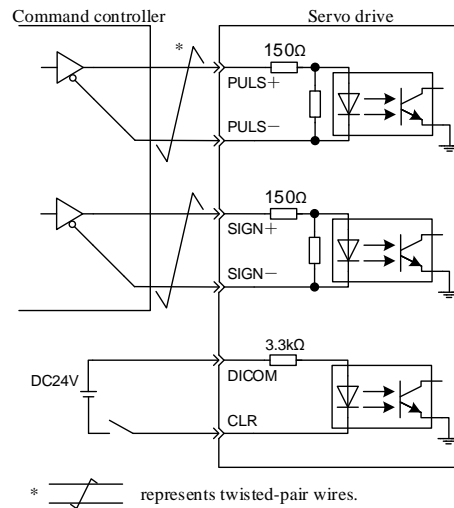

(b) Connection example of open-collector output

R1 value of limiting resistor should be selected to ensure that input current is within the range below.

Input current $i = 7\text{mA} \sim 15\text{mA}$

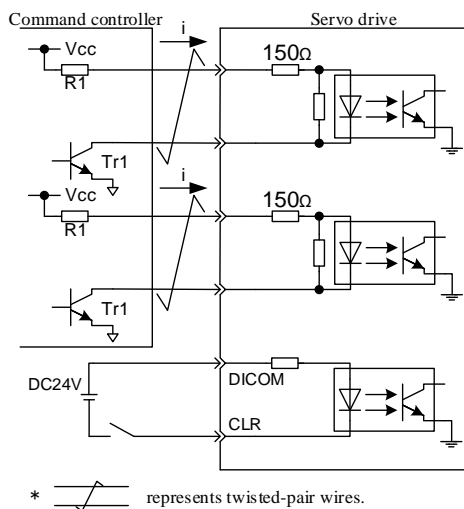

Please refer to the following applicable examples for setting of the working resistance R1 to maintain current i within 7 mA ~ 15 mA.

Applicable examples		
When Vcc is 24V R1=2.2KΩ	When Vcc is 12V R1=1KΩ	When Vcc is 5V R1=180Ω

(Note):

In case of open-collector outputs, noise margin of input signal will reduce. In case of offset caused by interference, user parameter P□200.3 should be set as "1".

(3) Chart of control box

Chart of control box is as below during position control.

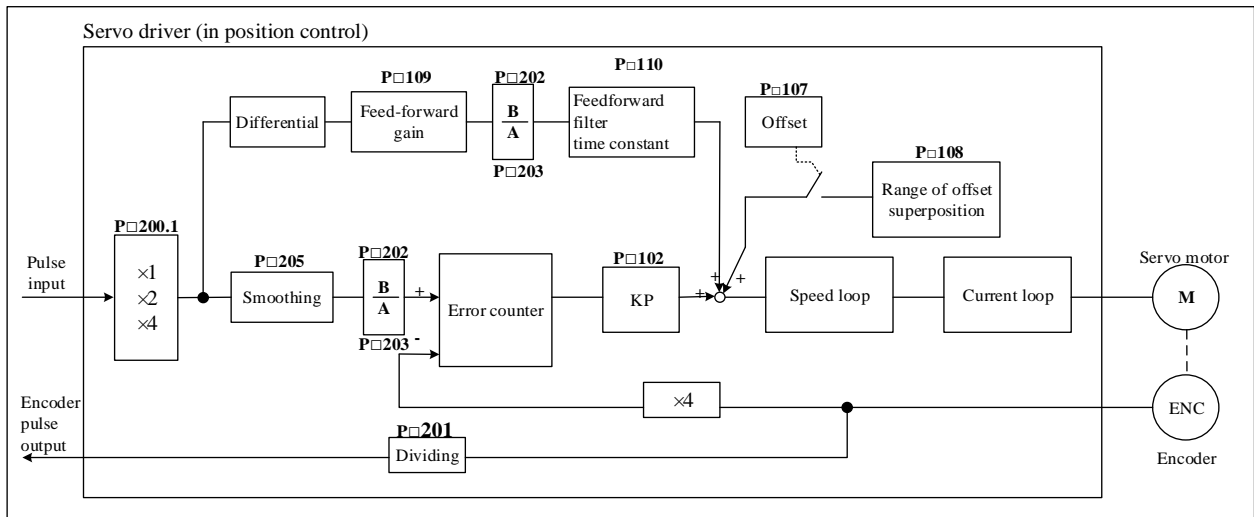

5.6.4 Smoothing

Filtering is available in the servo unit through reference pulse input with certain frequency.

(1) Selection of position reference filter

User Parameter	Meanings	
P□206	H.□□□0	First acceleration and deceleration filtering
	H.□□□1	Second acceleration and deceleration filtering

(2) User parameter related to filter

P□205	Position reference acceleration/deceleration filter time constant			Position
	Setting range	Setting unit	Factory setting	Power reboot
	0 ~ 6400	0.1ms	0	Not required

■ Attentions

Changing of position reference acceleration/deceleration time constant (Pn204) will take effects with no command pulse input and offset pulse of 0. To actually reflect the setting value, clear signal (CLR) should be input to disable reference pulse from command controller or to clear offset pulse as servo ON.

Even in following conditions, motor can be operated smoothly. In addition, the setting has no impact on movement (command pulse)

- When the host controller that outputs a reference cannot perform acceleration/deceleration processing.
- When the reference pulse frequency is too low.
- When the reference electronic gear ratio is too high (i.e., 10 times or more).

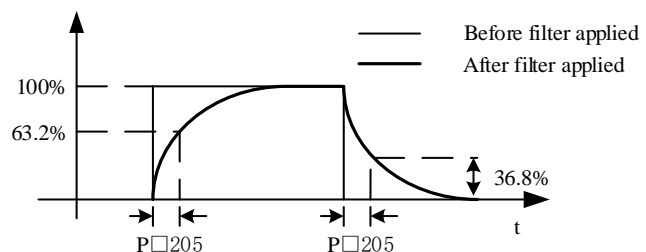

5.6.5 Positioning Completed Output Signal

The signal represents completion of servo motor positioning during position control, and should be used when interlocking is confirmed by positioning completion of command controller.

Name	Signal	Pin No. of connector (factory)		Set	Meanings
		A axis	B axis		
Output	/COIN	CN3-9	CN3-34	ON = L Level	Positioning completed
		CN3-10	CN3-35	OFF = H Level	Positioning not completed

Positioning completed signal can be distributed to other output terminals through user parameter P□513.
See "Signal distribution of output circuit" for distribution of output signal.

P□500	Positioning completion width			Position
	Setting range	Setting unit	Factory setting	Power reboot
	0 ~ 250	1 Reference unit	10	Not required

If difference (offset pulse) between the reference pulse from host controller and the movement of the servo motor is lower than the setting value of user parameter, positioning completed signal (/COIN) will be output.

Too large a value at this parameter may output only a small error during low-speed operation that will cause the /COIN signal to be output continuously.

The positioning completed width setting has no effect on final positioning accuracy.

5.6.6 Low-frequency Jitter Suppression

For low-rigidity load, rapid start-stop may produce continuous low-frequency jitter at early stage of loading, resulting in longer positioning and affecting production efficiency. Servo driver is equipped with jitter buffer control function which can suppress low-frequency jitter by estimating loading position and compensation.

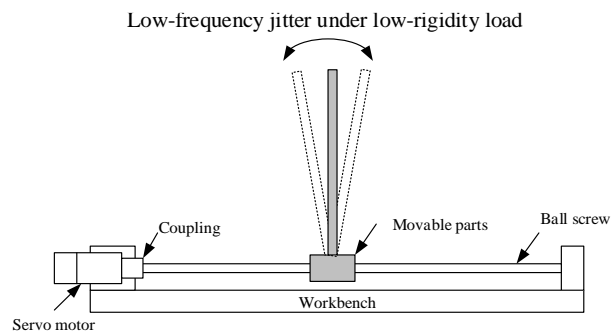

(1) Scope of Application

Low-frequency jitter suppression is available in speed control mode and position control mode.

Low-frequency jitter suppression may not work normally or reach expected effects in case of:

- Intensive vibration cause by external force
- Jitter frequency not within 5.0 Hz - 50.0 Hz
- Mechanical gap between mechanical joint parts of vibration structure
- Moving time lower than one vibration cycle

(2) Setting of user parameter

User Parameter	Meanings	
P□004	H. □0□□0	Disable low-frequency jitter suppression
	H. □1□□1	Enable low-frequency jitter suppression

P□413	B type vibration (low-frequency jitter) frequency			Speed	Position
	Setting range	Setting unit	Factory setting	Power reboot	
	10 ~ 1000	0.1Hz	1000	Not required	
P□414	B type vibration (low-frequency jitter) damping			Speed	Position
	Setting range	Setting unit	Factory setting	Power reboot	
	0 ~ 200	—	25	Not required	

After inputting load jitter frequency measured into parameter P□413, P□413 can be slightly adjusted to obtain best suppression.

In case of continuous vibration of motor during shutdown, P□414 can be increased suitable. Ordinary, parameter P□414 don't need modification .

If jitter frequency can be directly measured by instrument, such as laser interferometer, frequency measured should be directly input into parameter P□413 in the unit of 0.1 Hz.

In case of no measuring instrument available, drawing or FFT analysis function of PC communication software can be used to measure jitter frequency of load indirectly.

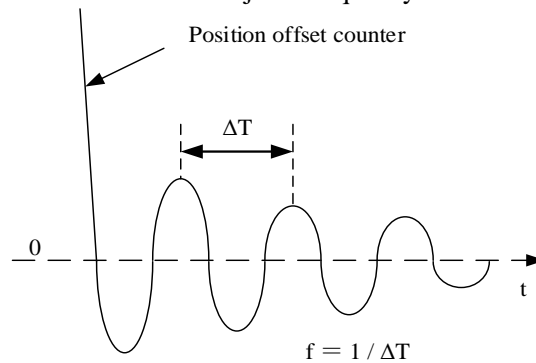

5.6.7 Inhibition Function of Reference Pulse (INHIBIT Function)

(1) Inhibition function of reference pulse (INHIBIT function)

It is the function to stop (inhibit) reference counting input pulses during position control.

When the function is activated, servo locking (clamping) state is also activated.

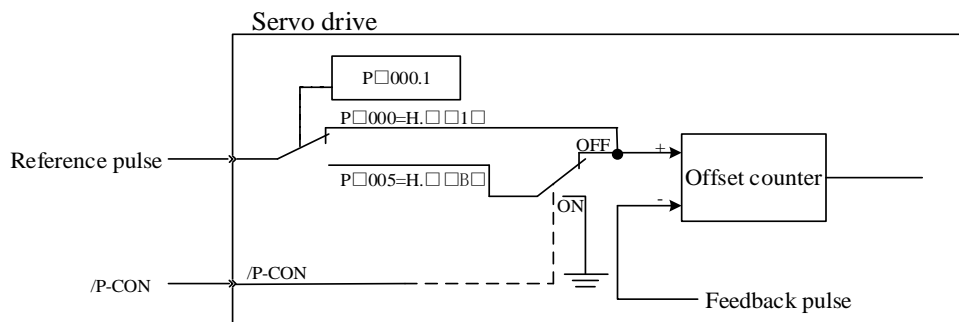

(2) Setting of user parameter

User Parameter	Meanings
P□000	H.□□B□ Control mode: position control (pulse train reference) ↔ position inhibition

■ Input specification

- Input range: DC $\pm 1V \sim \pm 10V$ / rated torque
 - Maximum allowable input voltage: DC $\pm 12V$
 - Factory settings
 - P□400 = 30: rated torque under 3 V
 - +3V input: rated torque in the positive direction
 - +9 V input: 300% of rated torque in the positive direction
 - 0.3 V input: 10 % of rated torque in the negative direction
- Voltage input range can be changed through user parameter P□400.

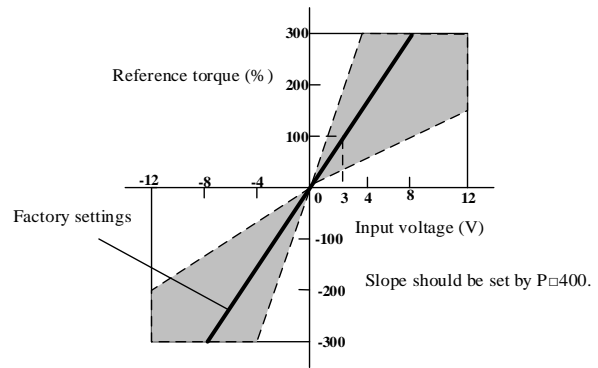

■ Example of input circuit

To adopt effective measures to prevent interference, multi-stranded wire should be used for wiring.

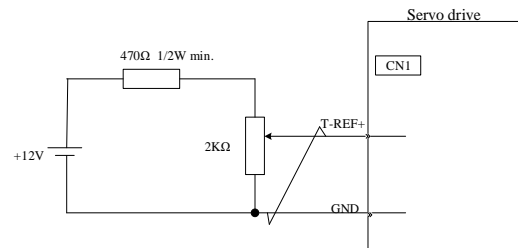

Note:

Internal torque can be confirmed under monitoring mode (Un005). See "Operation under Monitoring Mode".

5.7.3 Adjustment of Reference Offset

(1) Auto-adjustment of torque reference offset

In the torque control mode, the servomotor may rotate at a minute speed with an analog voltage reference of 0 V, This occurs because the reference voltage of the host controller or external circuit has a minute offset of a few millivolts. In such case, the offset can be automatically or manually adjusted by panel operator.

Auto-adjustment of analog (speed ·torque) or reference offset is the function for offset measurement and auto-adjustment of voltage.

In case of voltage reference offset of the host controller or in external circuit, servo driver will make following adjustment towards the automatic offset.

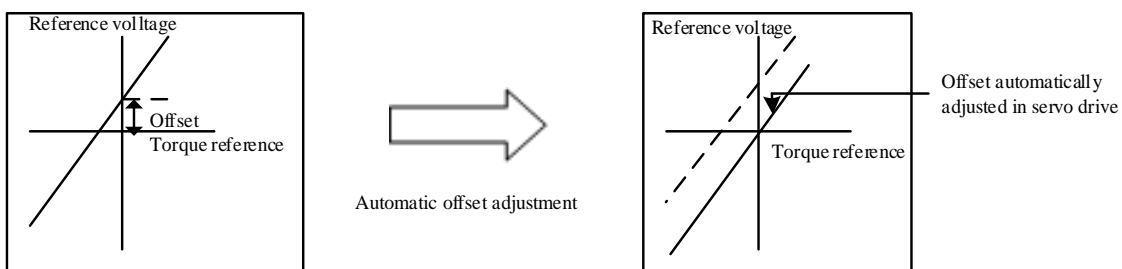







After auto-adjustment of reference offset, the value of offset will be saved in the servo driver.

Offset can be confirmed through manual adjustment of speed reference offset (F□006). When offset pulse is set as zero with the servo locked in the OFF state by the host controller equipped with a position loop, auto-adjustment of reference offset (F□008) is not available, instead, please use manual adjustment of speed reference offset (F□00A).

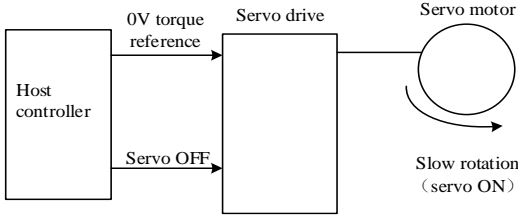
Under speed reference of zero, function of zero clamping speed control which can lock the servo in a mandatory manner is provided. See "Use of Zero Clamping Function" for details.

Note: Auto-adjustment of zero analog offset should be conducted when the servo is OFF.

Auto-adjustment of torque reference offset of A axis is conducted as below.

Operation steps	Operation instruction	Operation key	Display after operation
1			Turn OFF the servo drive, and input 0V reference voltage through host controller or external circuit.
2	Press M function key to select auxiliary function mode for A axis. In case of failing to display FA008, press UP or DOWN to set.	M	
3	Press SET, and "rEF_o" is displayed.	SET	
4	Press M function key to start auto-zeroing, and flickering "donE" is displayed.	M	
5	After completion of auto-zeroing, "rEF_o" instead of flickering "donE" is displayed.	—	
6	Press SET to return to the display of FA008.	SET	

(2) Manual adjustment of torque reference offset

Manual adjustment of torque reference offset (F□007) should be applied in case that:

- the host controller is equipped with a position loop to set the offset pulse as zero when the servo is locked in the OFF state
- the offset is set as a certain value consciously
- check the offset data that was set in the auto-adjustment mode.

Basic function and auto-adjustment of analog (speed · torque) reference offset (F□008) are the same. But for manual adjustment (F□007), adjustment must be made along with direct input of offset.

Figure below shows adjustment range of offset and setting unit.

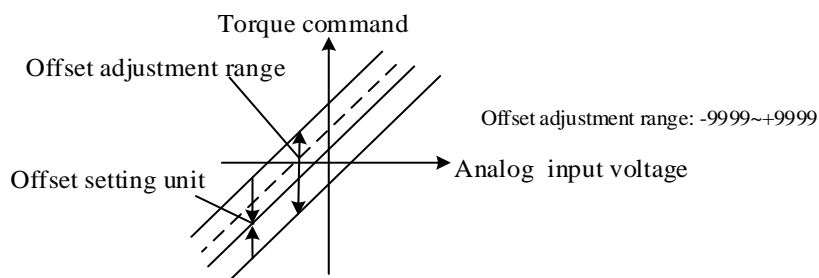

Auto-adjustment of torque reference offset of A axis is conducted as below.

Operation	Operation instruction	Operation	Display after operation
-----------	-----------------------	-----------	-------------------------

steps		key	
1	Press M function key to select auxiliary function mode for A axis. In case of failing to display FA006, press UP or DOWN to set.	M	FA007
2	Press SET, and "A.Tcr" is displayed.	SET	A.Tcr
3	Press SET for at least 1 s, and "0000" is displayed.	<	0000
4	Press UP or DOWN to set offset.	^ v	0083
5	Press SET for at least 1 s to save offset.	<	A.Tcr
6	Press SET to return to the display of FA007.	SET	FA007

5.7.4 Speed Limit under Torque Control

Servo motor in torque control is controlled by the specified torque output, but the motor speed is not controlled. If an excessive reference torque is set for the load torque on the mechanical side, then it will exceed the torque of the machinery, which will lead to greatly increase of motor speed.

As a protective measure at the mechanical side, a function of limiting servo motor speed under torque control is provided.

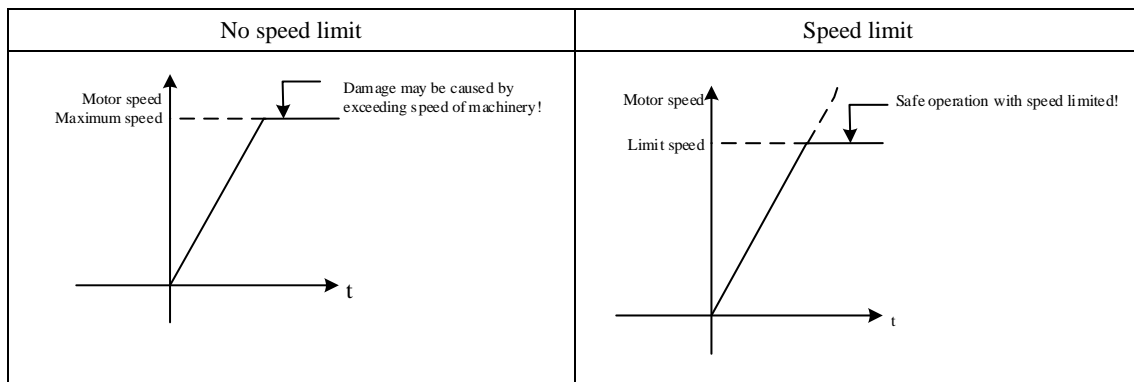

(1) Selection of speed limit manner (torque limit option)

User Parameter	Meanings
P□001	H.□0□□
	Value set in P□408 is used as speed limit. (Internal speed limiting function)
	H.□1□□
	V-REF is used as external speed limit input.

(2) Internal speed limiting function

P□408	Speed Limit During Torque Control			Torque
	Setting range	Setting unit	Factory setting	Power reboot
	0 ~ 6000	1r/min	1500	Not required
<p>This parameter set the limit speed under torque control. When P□001=H. □0□□, the setting in this parameter take effect. The servomotor's maximum speed will be used when the setting in this parameter exceeds the maximum speed of the servomotor used.</p>				

(3) External speed limiting function

Name	Signal	Pin No. of connector		Name
		A axis	B axis	
Input	V-REF	CN3-5	CN3-30	External speed limit input
	GND	CN3-6	CN3-31	Signal ground

Motor speed limit in case the torque limit is input under analog voltage reference.
When P□001=H. □1□□, the smaller one of V-REF speed limit input and P□408 (speed limit under torque control) is the valid value.
The setting in Pn300 determines the voltage level to be input as the limit value and it is not related to polarity.

P□300	Speed reference input gain			Speed	Position	Torque
	Setting range	Setting unit	Factory setting	Power reboot		
	0 ~ 3000	(r/min) /V	150	Not required		
<p>Under torque control, voltage level is set for the rotation speed for external speed limiting. When P□300=150 (factory setting), if the voltage input to the V-REF is 6 V, the actual speed limit is 900 r/min.</p>						

Note: Principle of speed limit.

If the speed is out of the range of speed limit, it may return to the range of speed limit through negative feedback of torque proportional to the speed difference with the limited speed. Therefore, actual motor speed limit will fluctuate based on loading conditions.

5.8 Speed Control (Internal Speed Selection) Operation

·Meaning of internal set speed selection

This function allows speed control operation by externally selecting an input signal from among three servomotor speed settings made in advance with parameters in the servodrive.

There is no need to provide a speed generator or pulse generator externally.

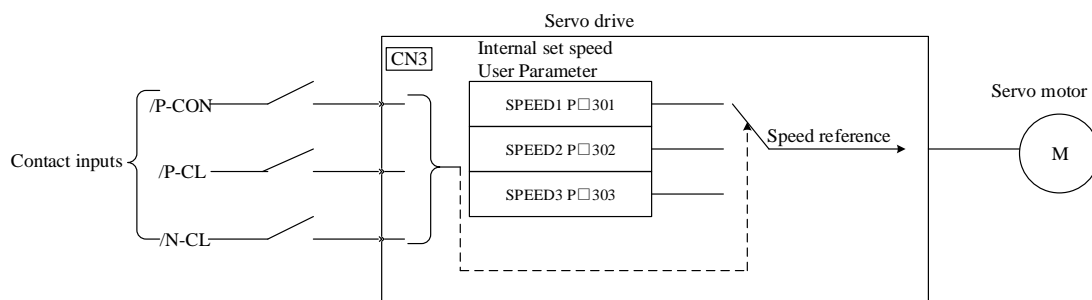

5.8.1 User Parameter Settings for speed control with an internally set speed

User Parameter		Meanings
P□000	H.□□3□	Selection of control manner: internal set speed control (contact reference)

P□301	Internal set speed 1			Speed
	Setting range	Setting unit	Factory setting	Power reboot
	0 ~ 6000	1r/min	100	Not required
P□302	Internal set speed 2			Speed
	Setting range	Setting unit	Factory setting	Power reboot
	0 ~ 6000	1r/min	200	Not required
P□303	Internal set speed 3			Speed
	Setting range	Setting unit	Factory setting	Power reboot
	0 ~ 6000	1r/min	300	Not required

Note:

Even through the value set in P□301~P□303 is larger than the maximum speed of the used servo motor, the actual value is still limited to the maximum speed of the servo motor.

5.8.2 Setting of Input Signal

Name	Signal	Pin No. of connector		Name
		A axis	B axis	
Input	/P-CON	CN3-15	CN3-40	Shift of rotation direction of servo motor
	/PCL	Need to distribute		Selection of internal set speed
	/NCL	Need to distribute		Selection of internal set speed

■ As for input signal selection
 For single-axis drive: /PCL and /NCL are respectively distributed to CN3-41 and CN3-42 when leaving factory.
 For double-axis drive: /PCL and /NCL need to be distributed by parameter P□510.
 Operation modes of the three input signals /P-CON, /P-CL and /N-CL are utilized (they are distributed in factory settings).

5.8.3 Operation at Internal Set Speed

Operation is allowed through internal settings by ON/OFF combination of the following input signals.

Input signal			Rotation direction of motor	
/P-CON	/PCL	/NCL		
OFF(H)	OFF(H)	OFF(H)	Positive rotation	Stop by the internal speed reference 0
	OFF(H)	ON(L)		P□301: internal set speed 1 (SPEED1)
	ON(L)	ON(L)		P□302: internal set speed 2 (SPEED2)
	ON(L)	OFF(H)		P□303: internal set speed 3 (SPEED3)
ON(L)	OFF(H)	OFF(H)	Negative	Stop by the internal speed reference 0
	OFF(H)	ON(L)		P□301: internal set speed 1 (SPEED1)
	ON(L)	ON(L)		P□302: internal set speed 2 (SPEED2)
	ON(L)	OFF(H)		P□303: internal set speed 3 (SPEED3)

Note:

In case that the control mode is switching mode

When P□000.1 = 4, 5, 6, if the signal of either /PCL or /NCL is OFF (H level), then the control mode is shifted.

For example, P□000.1=5: when internal set speed is set to select position control (pulse train)

Input signal		Speed
/PCL	/NCL	
OFF(H)	OFF(H)	Stop by the internal speed reference 0
OFF(H)	ON(L)	P□301: internal set speed 1 (SPEED1)
ON(L)	ON(L)	P□302: internal set speed 2 (SPEED2)
ON(L)	OFF(H)	P□303: internal set speed 3 (SPEED3)

· Operation example based on internal speed setting selection

If soft start function is used, then the impact during speed shifting will decrease.

Please refer to "Soft start" for soft start.

Example: operation based on internal set speed + soft start

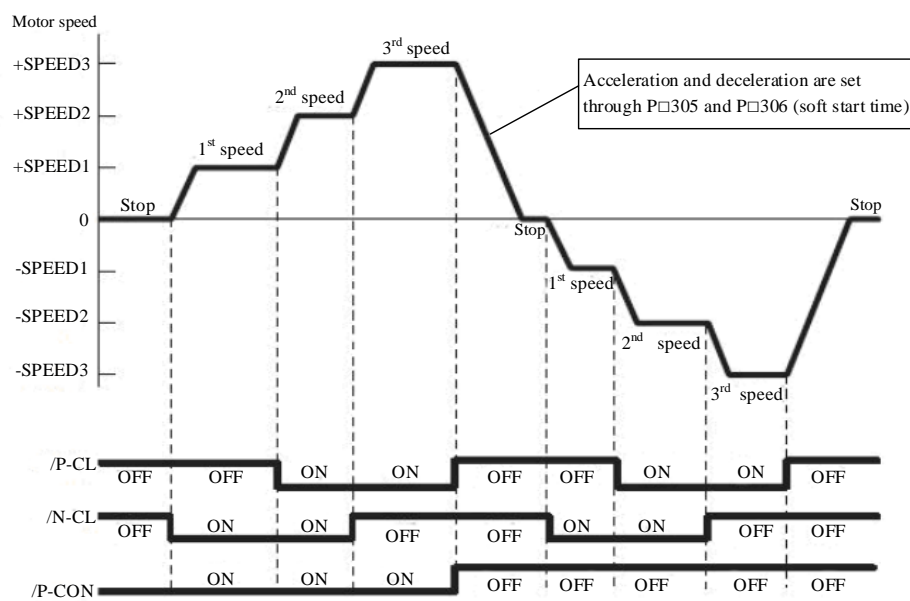

If "(P□000.1 = 5 internal set speed control" position control)" is set, the soft start function only works when the internal set speed is selected. The soft start function is not available when pulse reference is input. If it is shifted to pulse reference input during operation at any speed of speed 1-3, the servo drive will accept the pulse reference after output of positioning completion signal (/COIN). Please start output of pulse reference of user command controller only after output of positioning completion signal of servo drive. (Internal set speed + soft start) based <--> position control (operation example of pulse train reference)

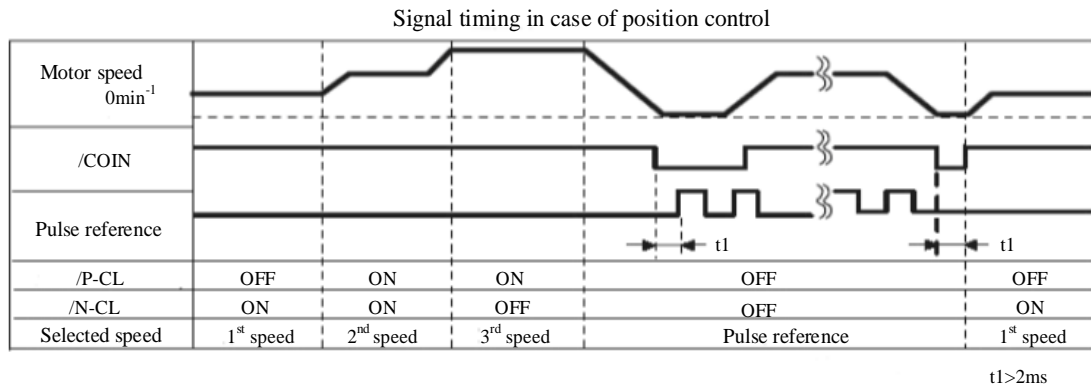
**Note:**

1. The soft start function is used in the figure above.
2. Value of $t1$ will not be affected by whether soft start function is used. Read-in of /PCL and /NCL may delay at most 2 ms.

5.9 Torque Limit

The servo driver provides the following four methods for limiting output torque to protect the machine.

Method	Way of limit	Reference
1	Internal torque limit	5.9.1
2	External torque limit	5.9.2
3	Torque limit by analog voltage reference	5.9.3
4	Torque limit by external torque limit + analog voltage reference	5.9.4

5.9.1 Internal Torque Limit (Limitation on Output Torque Maximum Value)

The function limits the maximum output torque through user parameters.

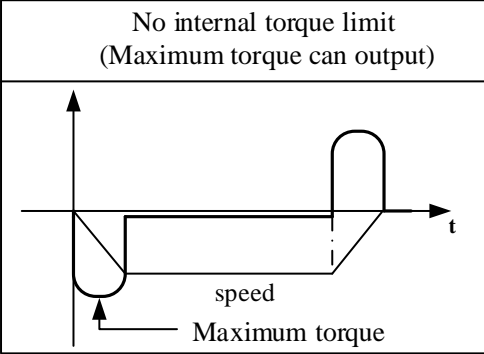
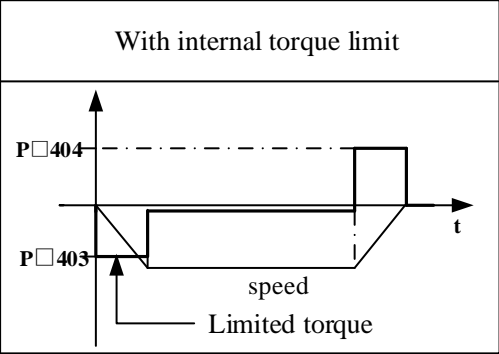
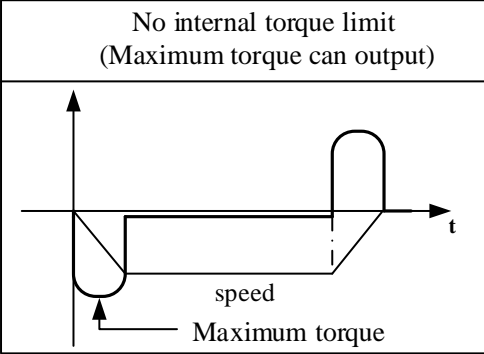
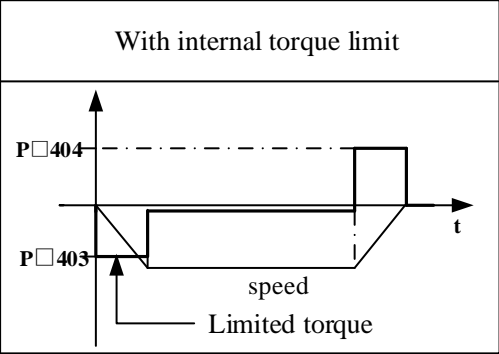
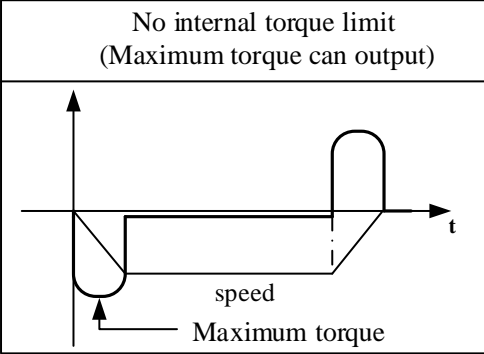
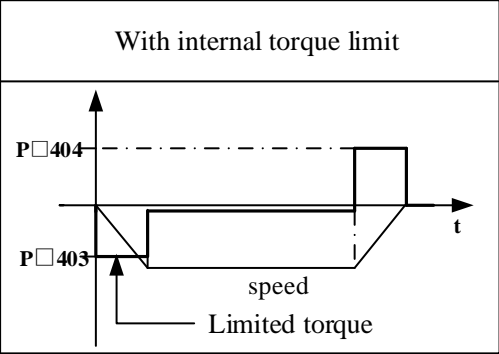
P□403	Positive torque limit			Speed	Position	Torque		
	Setting range	Setting unit	Factory setting	Power reboot				
	0 ~ 300	1%	300	Not required				
P□404	Negative torque limit			Speed	Position	Torque		
	Setting range	Setting unit	Factory setting	Power reboot				
	0 ~ 300	1%	300	Not required				
<p>Set value of this parameter is constantly valid. Set unit corresponds to a percent (%) of motor rated torque.</p> <p>Even through the value is set to exceed the maximum torque of the used servo motor, it will still be limited to be the actual maximum torque of the servo motor. Factory setting: equivalent to 300%.</p>								
<table border="1" style="width: 100%; text-align: center;"> <tr> <td style="width: 50%;"> <p>No internal torque limit (Maximum torque can output)</p>  </td> <td style="width: 50%;"> <p>With internal torque limit</p>  </td> </tr> </table>							<p>No internal torque limit (Maximum torque can output)</p> 	<p>With internal torque limit</p> 
<p>No internal torque limit (Maximum torque can output)</p> 	<p>With internal torque limit</p> 							
<p>■ Supplement</p> <p>Please note that if values of P□403 and P□404 are set to be too small, then torque may be insufficient during acceleration and deceleration of servo motor.</p>								

5.9.2 External Torque Limit (through Input Signal)

Use this function to limit torque by inputting a signal from the host controller at a specific times during machine operation, such as forced stop or hold operations for robot workpieces.

The torque limit value preset at the user parameter become valid through signal input.

(1) Related user parameter

P□405	Positive-side external torque limit			Speed	Position	Torque
	Setting range	Setting unit	Factory setting	Power reboot		
	0 ~ 300	1%	100	Not required		
P□406	Negative-side external torque limit			Speed	Position	Torque
	Setting range	Setting unit	Factory setting	Power reboot		
	0 ~ 300	1%	100	Not required		

Note: Setting unit corresponds to a percent (%) of the used servo motor rated torque. (Rated torque limits is 100%.)

(2) Input signal

Name	Signal	Pin No. of connector		Set	Meanings	Limit value
		A axis	B axis			

Input	/PCL	Different drives for single axis and double axis	ON = L Level	Positive-side external torque limit ON	The smaller value between Pn403 and Pn405
			OFF=H Level	Positive-side external torque limit OFF	Pn403
Input	/NCL	Different drives for single axis and double axis	ON = L Level	External torque limit at negative side OFF	The smaller value between Pn404 and Pn406
			OFF=H Level	Negative-side external torque limit OFF	Pn404

For single-axis drive: /PCL and /NCL are respectively distributed to CN3-41 and CN3-42 when leaving factory.
 For double-axis drive: /PCL and /NCL need to be distributed by parameter P□510.
 When using external torque limit, please confirm whether to distribute other signals to the same terminal of /P-CL and /N-CL.
 Since the logic becomes OR logic when several signals are distributed to a terminal, effects from ON/OFF of other signals distributed to the same terminal may be inevitable. Please refer to "Signal distribution of input circuit" for distribution of input signal.

(3) Changes in output torque during external torque limit

When external torque limit (P□403, P□404)=800%

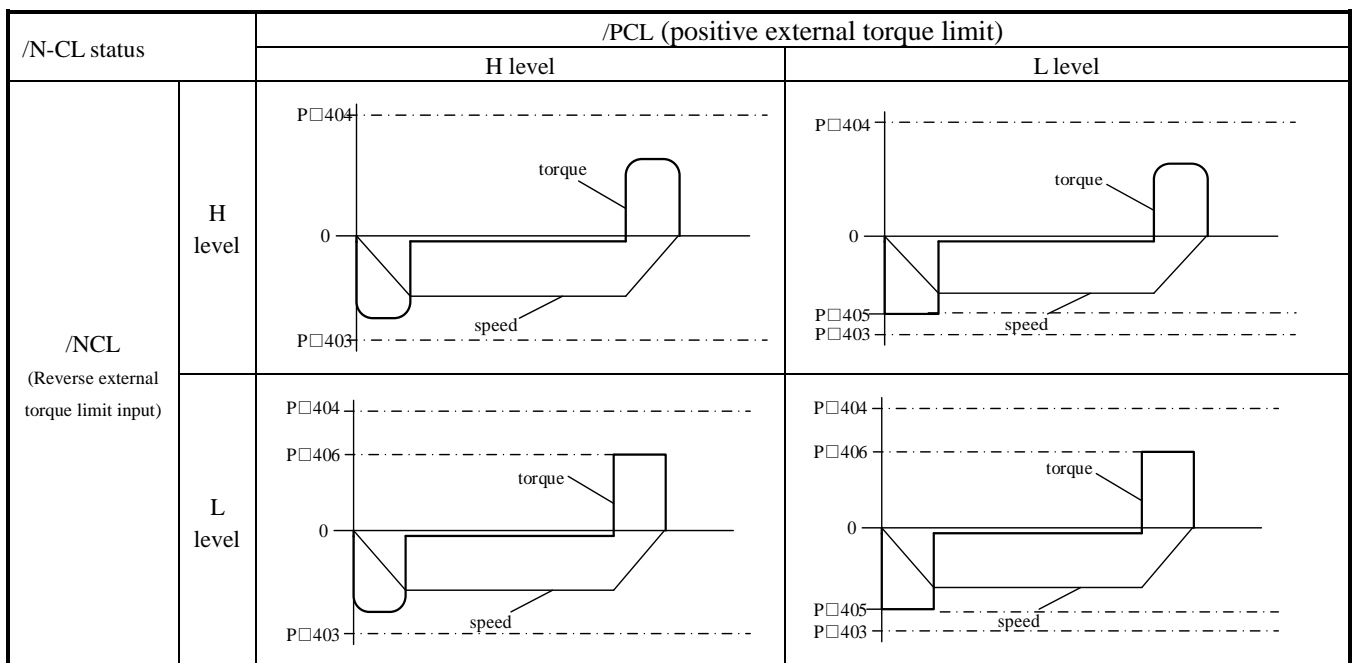

Note: Select motor rotation direction when setting P□000=H. □□□ 0 (standard setting [CCW as positive rotation direction]).

5.9.3 Torque Limit Based on Analog Voltage reference

Torque limiting by analog voltage reference limits torque by assigning a torque limit in an analog voltage to the T-REF terminals. This function can be used only during speed or position control, not during torque control.

Under speed control, the block diagram in the case of "torque limit based on analog voltage reference" is shown as below.

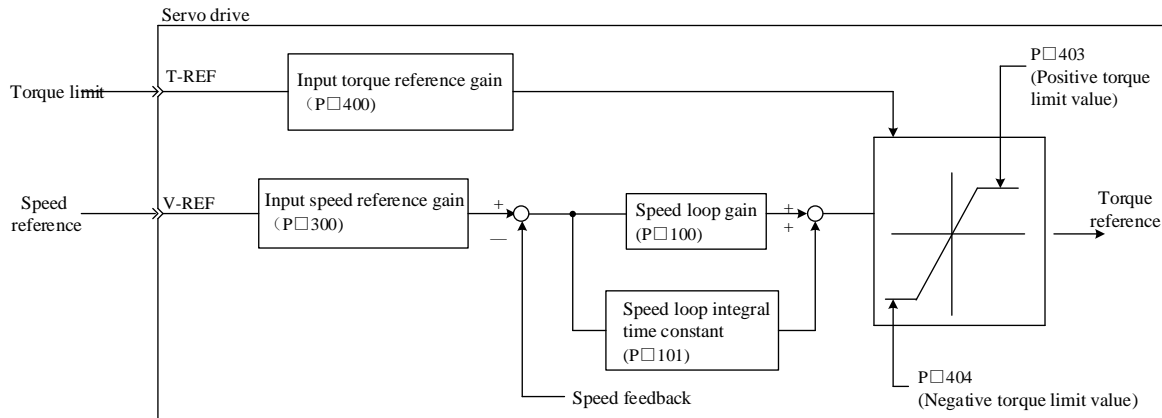

Note:

Input voltage for analog voltage reference of torque limit does not have polarity. The value is absolute value, no matter it is positive or negative, and the torque limit based on the absolute value is applicable to both positive and negative directions.

(1) Relevant user parameter

User Parameter	Meanings
P□001 H. □□1□	Speed control option: T-REF terminal is used as the external torque limit input.
If H. □□2□ is set, then T-REF terminal may also be used as the torque feed-forward input. However, please note that it cannot serve for these two input functions simultaneously.	

(2) Input signal

Name	Signal	Pin No. of connector		Name
		A axis	B axis	
Input	T-REF	CN3-18	CN3-30	Torque reference input
	GND	CN3-25	CN3-50	Signal ground

P□400 is used to set torque reference input gain. Please refer to "Setting of user parameter".

5.9.4 Torque Limit Based on External Torque Limit + Analog Voltage Reference

Torque limit based on external input signal and torque limit based on analog voltage reference can be used simultaneously.

For torque limit based on analog voltage reference, T-REF is used for input. Hence, it cannot work under torque control. For torque limit based on external input signal, /P-CL or /N-CL is used.

If signal of /P-CL (or /N-CL) is set to be ON, torque limit relies on the smaller one of torque limit based on analog voltage reference and the set value of P□405(or P□406).

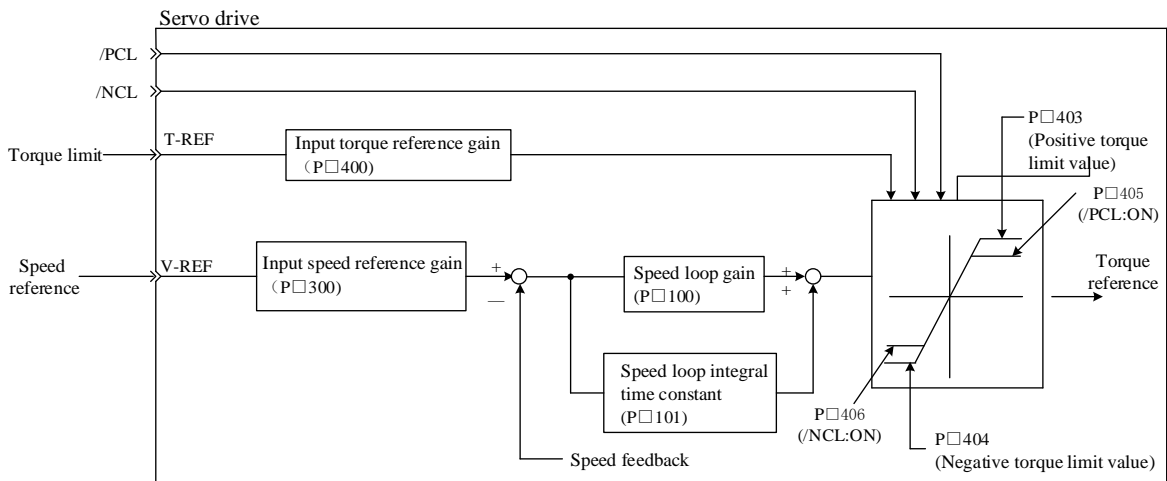

(1) Relevant user parameter

User Parameter		Meanings
P□001	H. □□3□	Speed control option: If /P-CL or /N-CL is valid, T-REF terminal is used as the external torque limit input.
If H. □□2□ is set, then T-REF terminal may also be used as the torque feed-forward input. However, please note that it cannot serve for these two input functions simultaneously.		

P□405	Positive-side external torque limit	<input type="checkbox"/> Speed	<input type="checkbox"/> Position	<input type="checkbox"/> Torque
	Setting range	Setting unit	Factory setting	Power reboot
	0 ~ 300	1%	100	Not required
P□406	External torque limit at negative side	<input type="checkbox"/> Speed	<input type="checkbox"/> Position	<input type="checkbox"/> Torque
	Setting range	Setting unit	Factory setting	Power reboot
	0 ~ 300	1%	100	Not required

(2) Input signal

Name	Signal	Pin No. of connector		Name
		A axis	B axis	
Input	T-REF	CN3-18	CN3-30	Torque reference input
	GND	CN3-25	CN3-50	Signal ground

P□400 is used to set torque reference input gain. Please refer to "Setting of user parameter".

Name	Signal	Pin No. of connector		Set	Meanings	Limit value
		A axis	B axis			
Input	/PCL	Different drives for single axis and double axis		ON = L Level	Positive-side external torque limit ON	The smaller value at Pn403 and Pn405
				OFF=H Level	Positive-side external torque limit OFF	Pn403
Input	/NCL	Different drives for single axis and double axis		ON = L Level	External torque limit at negative side OFF	The smaller value in Pn404 and Pn406
				OFF=H Level	Negative-side external torque limit OFF	Pn404

For single-axis drive: /PCL and /NCL are respectively distributed to CN3-41 and CN3-42 when leaving factory.
 For double-axis drive: /PCL and /NCL need to be distributed by parameter P□510.

When using external torque limit + torque limit based on analog voltage reference, please confirm whether to distribute other signals to the terminal same to /P-CL and /N-CL.

Since the logic becomes OR logic when several signals are distributed to a terminal, affect from ON/OFF of other signals distributed to the same terminal may be inevitable. Please refer to "Signal distribution of input circuit" for distribution of input signal.

5.9.5 Confirmation under Input Torque Limit

Name	Signal	Pin No. of connector (factory)		Set	Meanings
		A axis	B axis		
Output	/CLT	Need to distribute		ON = L Level	Motor input torque is under limiting
				OFF = H Level	Not torque limit status

To use the signal in case of motor output torque limit, it is necessary to distribute output terminal through user parameter P□514. Please refer to "Signal distribution of output circuit".

5.10 Control Mode Selection

The servo drive can be used with various control modes for shifting. The shifting method and conditions are described as follows.

5.10.1 User Parameter Setting

Control mode can be any of the following combination. Please select based on customers' usage.

User Parameter		Meanings
P□000	H. □□4□	Internal set speed control (contact reference) ↔ Speed control (analog reference)
	H. □□5□	Internal set speed control (contact reference) ↔ Position control (pulse train reference)
	H. □□6□	Internal set speed control (contact reference) ↔ Torque control (analog reference)
	H. □□7□	Position control (pulse train reference) ↔ Speed control (analog reference)
	H. □□8□	Position control (pulse train reference) ↔ Torque control (analog reference)
	H. □□9□	Torque control (analog reference) ↔ Speed control (analog reference)
	H. □□A□	Speed control (analog reference) ↔ Zero clamping
H. □□B□	Position control (pulse train reference) ↔ Position control (pulse prohibited)	

5.10.2 Shift of Control Mode

(1) Shift between internal set speed control (P□00.1 = 4, 5, 6)

Name	Signal	Pin No. of connector		Set	Meanings
		A axis	B axis		
Input	/PCL	Different drives for single axis and double axis		OFF = H Level	Shift of control mode
Input	/NCL	Different drives for single axis and double axis		OFF = H Level	

For single-axis drive: /PCL and /NCL are respectively distributed to CN3-41 and CN3-42 when leaving factory.
For double-axis drive: /PCL and /NCL need to be distributed by parameter P□510.

(2) Shift beyond internal speed control (P□000.1=7, 8, 9, A, B)

Please use the following signal shift control mode. Conduct the following control mode shift based on signal status.

Name	Signal	Pin No. of connector		Set	Setting of P□000				
		A axis	B axis		H.□□7□	H.□□8□	H.□□9□	H.□□A□	H.□□B□
Input	/PCON	CN3-15	CN3-40	ON = L Level	Speed	Torque	Speed	Zero clamping	Prohibited
				OFF = H Level	Position	Position	Torque	Speed	Position

5.11 Other Output Signal

Describe other signals that can be output, although they have no direct relationship with various control manners.

5.11.1 Servo Alarm Output (ALM)

(1) Servo alarm output (ALM)

Refer to signals output when the servo drive detects any abnormalities.

Name	Signal	Pin No. of connector (factory)		Set	Meanings
		A axis	B axis		
Output	ALM	CN3-7	CN3-32	ON = L Level	Normal status of servo drive
		CN3-8	CN3-33	OFF = H Level	Alarm status of servo drive
■Attentions If constituting an external circuit, it is necessary to ensure the main circuit power supply of servo drive is set to be OFF when the alarm is output.					

(2) Reset alarm

Name	Signal	Pin No. of connector (factory)		Name
		A axis	B axis	
Input	/ALM-RST	Different drives for single axis and double axis		
For single-axis drive: /PCL and /NCL are respectively distributed to CN3-41 and CN3-42 when leaving factory. For double-axis drive: /PCL and /NCL need to be distributed by parameter P□510. This signal may be distributed to other pin number through user parameter P□510. Please refer to "Signal distribution of input circuit" for detailed procedures. /ALM-RST signal is set based on distribution of external input signal, so it cannot be set to be "constantly valid". Please use the action of setting level from H to L to reset alarm. In case of "servo alarm (ALM)", finish troubleshooting and set this signal (/ALM-RST) from OFF (H level) to ON (L level) to reset to alarm status. In addition, alarm reset can also be done through panel operator or digital operator. Please refer to "Name and function of key".				

Note:

1. Sometimes alarms related encoder cannot reset after /ARM-RST signal input. In such cases, please cut down control power supply to reset.
2. In case of alarm, please reset only after troubleshooting.
 Troubleshooting methods for alarms are described in the "Alarm displays and treatment measures".

5.11.2 Rotation Detection Output (/TGON)

Name	Signal	Pin No. of connector (factory)		Set	Meanings
		A axis	B axis		
Output	/TGON	CN3-11	CN3-36	ON = L Level	Servo motor is rotating (motor speed is larger than the set value of P□502)
		CN3-12	CN3-37	OFF = H Level	Servo motor stops rotating (motor speed is larger than the set value of P□502)
■Attentions When brake signal (/BK) and rotation detection signal (/TGON) are distributed to the same output terminal, /TGON signal is changed to L level, but /BK signal may cannot change to H level. (The reason is that OR logic prevails for output when several output signals are distributed to the same output terminal) Please distribute (/TGON) signal and (/BK) signal to other terminals.					

5.11.3 Servo Ready Output (/S-RDY)

Name	Signal	Pin No. of connector (factory)		Set	Meanings
		A axis	B axis		
Output	/S-RDY	Need P□513 for distribution		ON = L Level	Servo ready status
				OFF = H Level	Servo not ready status
Indicate that servo unit is under the status ready for servo ON signal reception.					
Output when the main circuit power supply is ON and under the status of no servo alarm.					

5.12 Mode Motion Sequence Manner

The Product supports 15 data sets that can set parameters in the parameter manner, 32 data sets that can set parameters in the communication manner. These data sets can start up independently or in sequence.

Data sets that can set parameters contain the setting about data set types and the setting of related goal value and subsequent data sets.

The following motion types are available in motion type:

- Invalid motion (null data)
- Absolute motion
- Relative motion

Data sets can start up through 2 different manners.

- Start up a single data set

For startup of a single data set, only the selected data set starts up. No other data sets will start up upon successful execution of the data set. Time coordination among several data sets is then completed through main control system (e.g. PLC).

- Start up a data set sequence (several data sets in sequence)

For startup of a sequence, the selected data set will start up first. When a data set is executed successfully and the transitional conditions are fulfilled, subsequent data sets will then start up. Time coordination among several data sets is then completed through the product.

5.12.1 Single Data Set Manner

In the single data set manner, 15 sets of internal motion tasks are available. Mode of motion can be incremental or absolute.

(1) Setting of user parameter

User Parameter		Meanings
P□000	H.□□C□	Selection of control mode: mode motion sequence manner
P□764	H.□□□0	Selection of data set startup manner: single data set manner

P□700	Type of data set 0			Position
	Setting range	Setting unit	Factory setting	Power reboot
	0 ~ 2	---	0	Required
0: Data set is invalid. 1: The data set is an absolute movement. 2: The data set for the relative movement.				
P□701	Low position of data set 0			Position
	Setting range	Setting unit	Factory setting	Power reboot
	-9999 ~ +9999	1-reference pulse	0	Required
P□702	High position of data set 0			Position
	Setting range	Setting unit	Factory setting	Power reboot
	-9999 ~ +9999	10000-reference pulse	0	Required
P□703	Speed of data set 0			Position
	Setting range	Setting unit	Factory setting	Power reboot
	0 ~ 6000	1r/min	0	Required
1、Data set 1 parameters P□708 ~ P□711; Data set 2 parameters P□716 ~ P□719; Data set 3 parameters P□724 ~ P□727; Data set 4 parameters P□732 ~ P□735; Data set 5 parameters P□740 ~ P□743; Data set 5 parameters P□748 ~ P□751; Data set 7 parameters P□756 ~ P□759。				

P□765	Acceleration of data set			Position
	Setting range	Setting unit	Factory setting	Power reboot
	1 ~ 60000	10r/min/s	10000	Required
P□766	Deceleration of data set			Position
	Setting range	Setting unit	Factory setting	Power reboot
	1 ~ 60000	10r/min/s	10000	Required
P□767	Emergency deceleration of data set			Position
	Setting range	Setting unit	Factory setting	Power reboot
	1 ~ 60000	10r/min/s	60000	Required
P□768	Electronic gear of data set (numerator)			Position
	Setting range	Setting unit	Factory setting	Power reboot
	1 ~ 65535	---	2	Required
P□769	Electronic gear of data set (denominator)			Position
	Setting range	Setting unit	Factory setting	Power reboot
	1 ~ 65535	---	1	Required

(2) Setting of input signal

Name	Signal	Pin No. of connector		Name
		A axis	B axis	
Input	/POS-START	Need P□512 for distribution		Startup signal of mode motion sequence
Input	/POS-STEP	Need P□512 for distribution		Step change signal of mode motion sequence
Input	/POS0	Need P□511 for distribution		Option switch 0 signal of data sets in mode motion sequence
Input	/POS1	Need P□511 for distribution		Option switch 1 signal of data sets in mode motion sequence
Input	/POS2	Need P□511 for distribution		Option switch 2 signal of data sets in mode motion sequence
Input	/PCON	Need P□509 for distribution		Option switch 3 signal of data sets in mode motion sequence

In the single data set manner, when /POS-START signal is ON, the motor is allowed to operate; when it is OFF, the motor stops operation.

For input signals (/POS-START, /POS-STEP, /POS0, /POS1, /POS2, /PCON), any of the 15 data sets are available for selection as the current data set to be executed. The data sets are as follows:

Data set	/POS2	/POS1	/POS0	/POS-START	/POS-STEP	Corresponding parameter
P0	OFF	OFF	OFF	ON	↑	P□700 ~ P□703
P1	OFF	OFF	ON	ON	↑	P□708 ~ P□711
P2	OFF	ON	OFF	ON	↑	P□716 ~ P□719
P3	OFF	ON	ON	ON	↑	P□724 ~ P□727
P4	ON	OFF	OFF	ON	↑	P□732 ~ P□735
P5	ON	OFF	ON	ON	↑	P□740 ~ P□743
P6	ON	ON	OFF	ON	↑	P□748 ~ P□751
P7	ON	ON	ON	ON	↑	P□756 ~ P□759

Sequence diagram of input signals and data sets is as below:

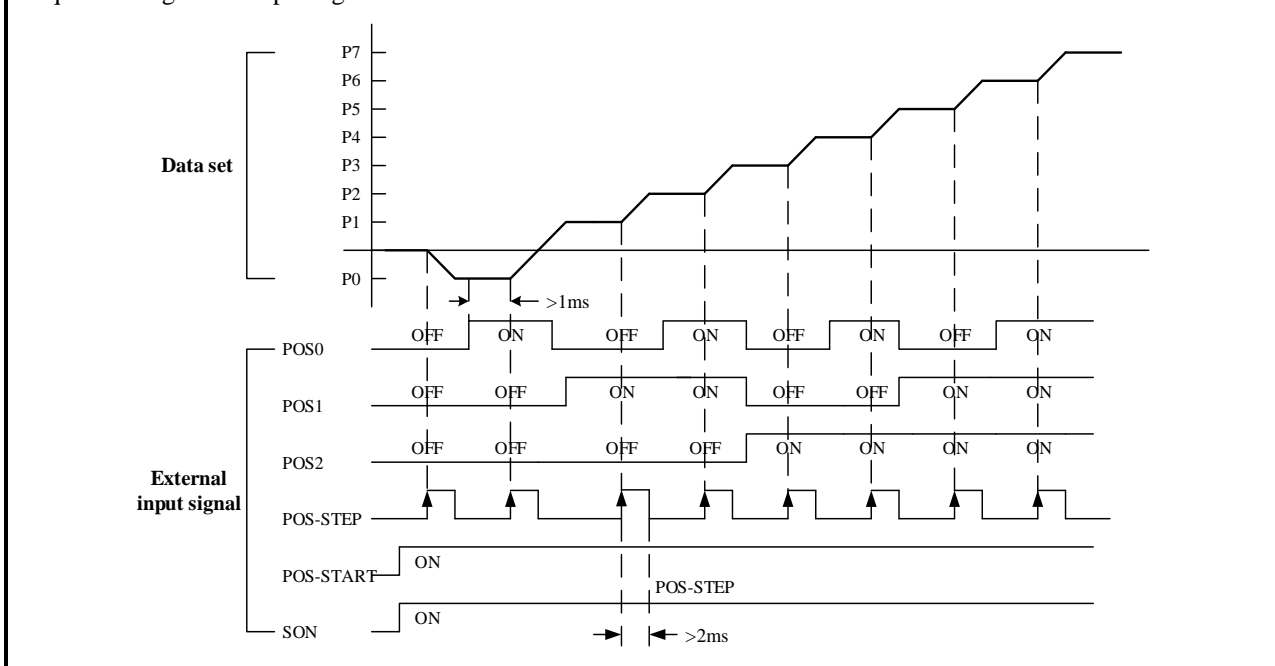

5.12.2 Data Set Sequence Mode

The data set sequence manner supports 8 data sets in the parameter manner and 32 data sets in the communication manner. Mode of motion can be incremental or absolute.

(1) Setting of user parameter

User Parameter		Meanings
P□000	H.□□C□	Selection of control mode: mode motion sequence manner
P□764	H.□□□0	Selection of data set startup manner: single data set manner

P□700	Type of data set 0			Position
	Setting range	Setting unit	Factory setting	Power reboot
	0 ~ 2	---	0	Required

0: data set is invalid
1: data set is in absolute motion
2: data set is in relative motion

User Parameter		Meanings
P□704	H.□□□0	No step change condition, directly start up subsequent data sets; 2nd step change condition invalid.
	H.□□□1	Delay step change, with delay time as "step change condition value 1" in the data set
	H.□□□2	Pulse edge step change, with "step change condition value 1" in the data set determining validity of rising edge or falling edge.
	H.□□□3	Level step change, with "step change condition value 1" in the data set determining validity of rising edge or falling edge.

User Parameter		Meanings
P□704	H.□□0□	No step change condition, directly start up subsequent data sets.
	H.□□1□	No step change condition, directly start up subsequent data sets.
	H.□□2□	Pulse edge step change, with "step change condition value 2" in the data set determining validity of rising edge or falling edge.
	H.□□3□	Level step change, with "step change condition value 2" in the data set determining validity of rising edge or falling edge.

P□705	Step change condition value of data set 0			Position
	Set range	Set unit	Factory setting	Power reboot
	0 ~ 65535	---	0	Required

The parameter significance depends on the types of data set step change condition 1, as below:

- No step change condition
 - Insignificant
- Delay step change
 - Delay time 0 ~ 65535, unit: ms
- Pulse edge step change
 - Value 0: rising edge step change
 - Value 1: falling edge step change
 - Value 2: rising edge or falling edge step change
 - Other value: invalid
- Pulse edge step change
 - Value 3: H level step change
 - Value 4: L level step change
 - Other value: invalid

P□706	Step change condition value of data set 2			Position
	Set range	Set unit	Factory setting	Power reboot
	0 ~ 65535	---	0	Required

The parameter significance depends on the types of data set step change condition 2, as below:

- No step change condition
 - Insignificant
- Delay step change
 - Delay time 0 ~ 65535, unit: ms
- Pulse edge step change
 - Value 0: rising edge step change
 - Value 1: falling edge step change
 - Value 2: rising edge or falling edge step change
 - Other value: invalid
- Pulse edge step change
 - Value 3: H level step change
 - Value 4: L level step change
 - Other value: invalid

User Parameter	Meanings	
P□704	H.□0□□	No conjunction, step change condition 2 invalid
	H.□1□□	"And" conjunction between condition 1 and 2.
	H.□2□□	"Or" conjunction between condition 1 and 2.

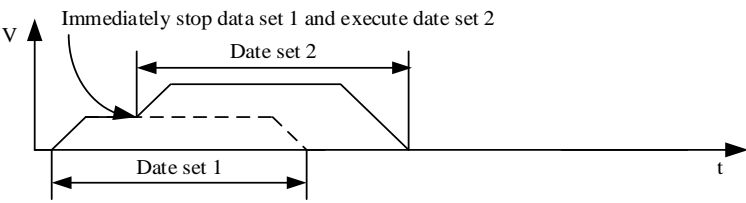
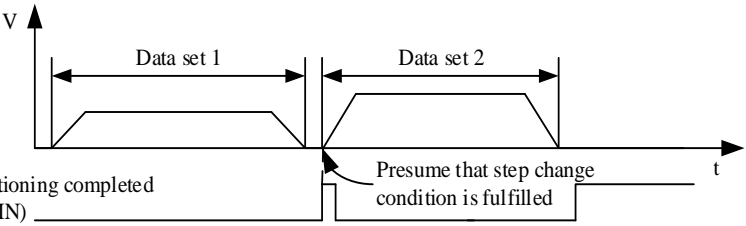
User Parameter	Meanings	
P□705	H.0□□□	<p>Aborting: neglect step change condition, immediately interrupt motion, and start up subsequent data sets.</p>  <p>The graph shows velocity (V) on the y-axis and time (t) on the x-axis. Data set 1 is a trapezoidal pulse. At its end, the velocity drops to zero. Data set 2 starts immediately after the stop of Data set 1. A dashed line shows the original path of Data set 1.</p>
	H.1□□□	<p>Standard: when the current motion is in place and the step change condition is fulfilled, start up subsequent data sets.</p>  <p>The graph shows velocity (V) on the y-axis and time (t) on the x-axis. Data set 1 is a trapezoidal pulse. After it is completed (COIN), the velocity remains at zero. Data set 2 starts after a delay. A signal labeled 'Presume that step change condition is fulfilled' is shown as a pulse during this delay.</p>
	H.2□□□	<p>Standard: after reaching the goal position and if the step change condition is fulfilled, start up subsequent data sets.</p>

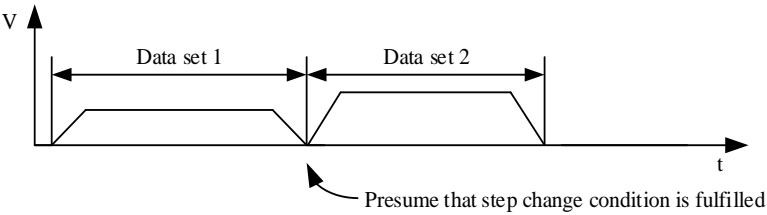
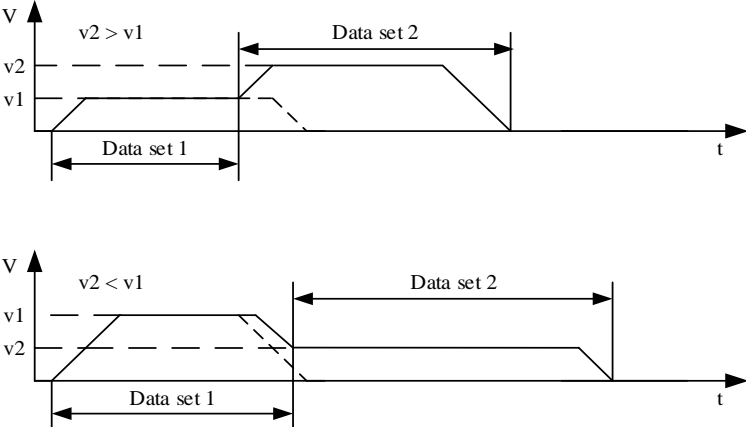
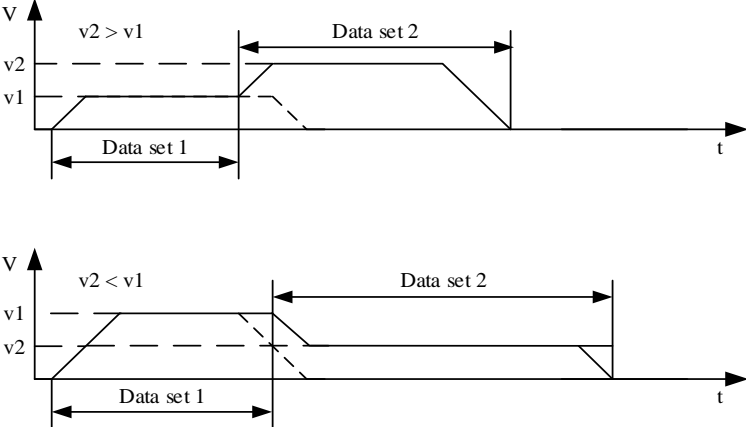
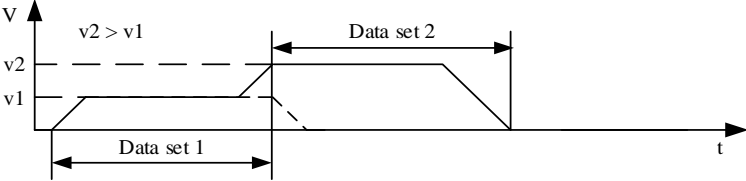
		 <p>Presume that step change condition is fulfilled</p>
<p>H.3□□□</p>	<p>BlendingLow: neglect step change condition, and after reaching the goal position, adjust speed based on the speed of subsequent data set.</p>	
<p>H.4□□□</p>	<p>BlendingPrevious: neglect step change condition, and after reaching the goal position, adjust speed based on the speed of subsequent data set.</p>	
<p>H.5□□□</p>	<p>BlendingNext: neglect step change condition, and after reaching the goal position, adjust speed based on the speed of subsequent data set.</p>	

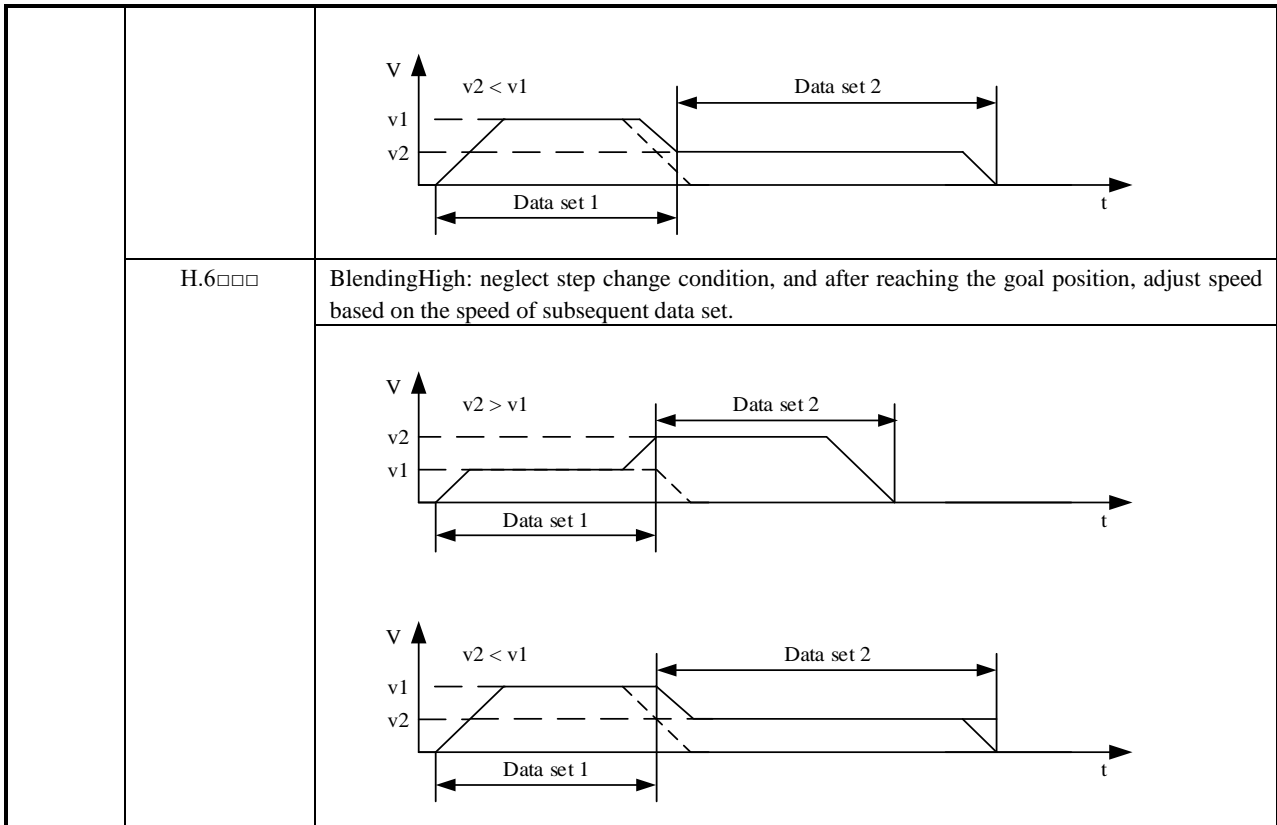

H.6□□□

BlendingHigh: neglect step change condition, and after reaching the goal position, adjust speed based on the speed of subsequent data set.

P□707	Subsequent data set number after data set 0			Position
	Setting range	Setting unit	Factory setting	Power reboot
	0 ~ 7	1r/min	0	Required
1、 Data set 1 parameters P□708 ~ P□715; Data set 3 parameters P□724 ~ P□731; Data set 5 parameters P□740 ~ P□747; Data set 7 parameters P□756 ~ P□763。		Data set 2 parameters P□716 ~ P□713; Data set 4 parameters P□732 ~ P□739; Data set 6 parameters P□748 ~ P□755;		

P□765	Acceleration of data set			Position
	Setting range	Setting unit	Factory setting	Power reboot
	1 ~ 60000	10r/min/s	10000	Required
P□766	Deceleration of data set			Position
	Setting range	Setting unit	Factory setting	Power reboot
	1 ~ 60000	10r/min/s	10000	Required
P□767	Emergency deceleration of data set			Position
	Setting range	Setting unit	Factory setting	Power reboot
	1 ~ 60000	10r/min/s	60000	Required
P□768	Electronic gear of data set (numerator)			Position
	Setting range	Setting unit	Factory setting	Power reboot
	1 ~ 65535	---	2	Required
P□769	Electronic gear of data set (denominator)			Position
	Setting range	Setting unit	Factory setting	Power reboot
	1 ~ 65535	---	1	Required

(2) Setting of input signal

Name	Signal	Pin No. of connector		Name
		A axis	B axis	
Input	/POS-START	Need P□512 for distribution		Startup signal of mode motion sequence
Input	/POS-STEP	Need P□512 for distribution		Step change signal of mode motion sequence
When /POS-START signal is from OFF → ON, the motor is allowed to operate; when it is OFF, the motor stops operation.				
■Attentions Every time after servo is OFF (or alarm is solved) and before data set sequence is rerun, it is necessary to set /POS-START signal from ON to OFF and then ON so as to start up load data set.				

5.12.3 Operation of Seeking Reference Point (Return to Zero)

Zero point can also be determined through reference point and it is the reference point in the absolute motion in mode motion sequence manner.

(1) Setting of user parameter

User Parameter		Meanings
P□770	H.□□□0	Current position is zero point
	H.□□□1	For on-off operation of seeking NOT in the negative direction, C pulse is required

H.□□□2	For on-off operation of seeking POT in the negative direction, C pulse is required	
H.□□□3	For on-off operation of seeking reference point in the negative direction, C pulse is required	
H.□□□4	For on-off operation of seeking reference point in the positive direction, C pulse is required	
H.□□□5	For on-off operation of seeking NOT in the negative direction, C pulse is not required	
H.□□□6	For on-off operation of seeking POT in the negative direction, C pulse is not required	

	H.0007	<p>For on-off operation of seeking reference point in the negative direction, C pulse is not required</p>
	H.0008	<p>For on-off operation of seeking reference point in the positive direction, C pulse is not required</p>
P0770	H.0000	Not return to zero automatically after power-on.
	H.1000	After power-on, return to zero automatically after 1st servo is enabled, with the return to zero manner determined by P0770.0.

P0771	On-off speed to meet reference point			Position
	Setting range	Setting unit	Factory setting	Power reboot
	0 ~ 6000	1r/min	100	Required
P0772	On-off speed to leave reference point			Position
	Setting range	Setting unit	Factory setting	Power reboot
	0 ~ 6000	1r/min	30	Required

(2) Setting of input signal

Name	Signal	Pin No. of connector		Name
		A axis	B axis	
Input	/POS-START	Need P0512 for distribution		Startup signal of mode motion sequence
Input	/HOME-REF	Need P0512 for distribution		Zero reference on-off
Input	/POS-START-HOME	Need P0512 for		Start return to zero operation and seek for zero point as per

		distribution	P□770.0 setting.
When /POS-START signal is ON, the motor is allowed to operate (return to zero allowed); when it is OFF, the motor suspends operation (return to zero suspended).			

Chapter VI Communication

ZSD-K servo drives are equipped with standard MODBUS communication of RS485 interface and optional CANopen of CAN interface (conforming to DS301 and DS402 standard protocols). The Chapter mainly describes MODBUS communication.

6.1 Communication Wiring

Signal name and functions of communication connector are as follows:

Terminal No.		1	2	3	4	5	6	7	8
Name	CN4	CANH-	CANL	GND	GND	RS485+	RS485-	Reserved	Reserved
	CN5	CANH-	CANL	GND	GND	RS485+	RS485-	Built-in 120 ohm resistance	

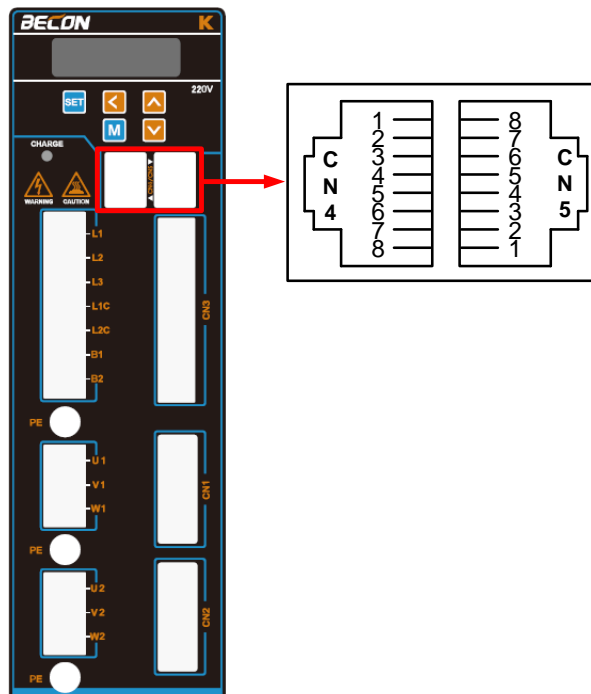

Servo drive CN4 always acts as communication cable input terminal and CN5 always as communication cable output terminal. Wiring diagram of several servo drives are as follows:

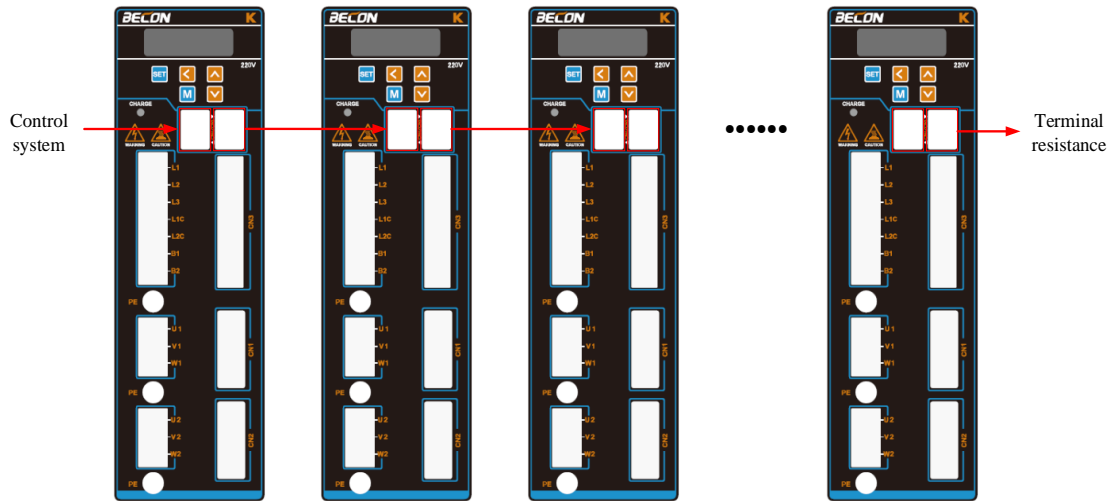

6.2 User Parameter

User Parameter		Meanings
P□600	H.□□□0	RS485 communication baud rate: 4800 bps
	H.□□□1	RS485 communication baud rate: 9600 bps
	H.□□□2	RS485 communication baud rate: 19200 bps
	H.□□□3	RS485 communication baud rate: 38460 bps
	H.□□□4	RS485 communication baud rate: 57600 bps
P□600	H.□□0□	ASCII, 7 data bits, no parity, 2 stop bits
	H.□□1□	ASCII, 7 data bits, even parity bit, 2 stop bits
	H.□□2□	ASCII, 7 data bits, odd parity bit, 2 stop bits
	H.□□3□	ASCII, 8 data bits, no parity, 1 stop bits
	H.□□4□	ASCII, 8 data bits, even parity bit, 1 stop bits
	H.□□5□	ASCII, 8 data bits, odd parity bit, 1 stop bits
	H.□□6□	RTU, 8 data bits, no parity, 1 stop bit
	H.□□7□	RTU, 8 data bits, even parity bit, 1 stop bit
	H.□□8□	RTU, 8 data bits, odd parity bit, 1 stop bit

P□601	RS-485 communication axis address			Speed	Position	Torque
	Setting range	Setting unit	Factory setting	Power reboot		
	1 ~ 127	---	1 (A axis),2 (b axis)	Required		
P□602	RS-485 communication timeout			Speed	Position	Torque
	Setting range	Setting unit	Factory setting	Power reboot		
	0 ~ 1000	100ms	0	Not required		
<ul style="list-style-type: none"> When P□602 is set to be zero, shut down communication timeout detection; When P□602 is set to be larger than zero, indicate that communication shall be done within a set time, or else communication error will appear. For example, if P□602 is set to be 50, indicate that one time of communication with servo drive every 5 seconds is necessary. 						

6.3 MODBUS Communication Protocol

In case of RS-485 communication, every servo drive must have parameters P□600 ~ P□601 preset. In case of MODBUS protocol for communication, the following two modes are available:

ASCII mode

RTU mode.

The following is the description of MODBUS communication.

■ Code meaning

ASCII mode:

Every 8-bit datum consists of two ASCII characters. For example, one 1-byte datum 64_H (sexadecimal notation). ASCII code "64" indicates it includes ASCII code (36_H) of '6' and ASCII code (34_H) of '4'. ASCII codes of digits 0-9 and alphabets A-F are as shown in the table below:

Character symbol	'0'	'1'	'2'	'3'	'4'	'5'	'6'	'7'
Corresponding ASCII code	30 _H	31 _H	32 _H	33 _H	34 _H	35 _H	36 _H	37 _H
Character symbol	'8'	'9'	'A'	'B'	'C'	'D'	'E'	'F'
Corresponding ASCII code	38 _H	39 _H	41 _H	42 _H	43 _H	44 _H	45 _H	46 _H

RTU mode:

Every 8-bit datum consists of two 4-bit sexadecimal data. For instance, decimal 100 presents to be 64_H when using 1-byte RTU data.

■ Character structure

10 bit character format (for 7-bit data)

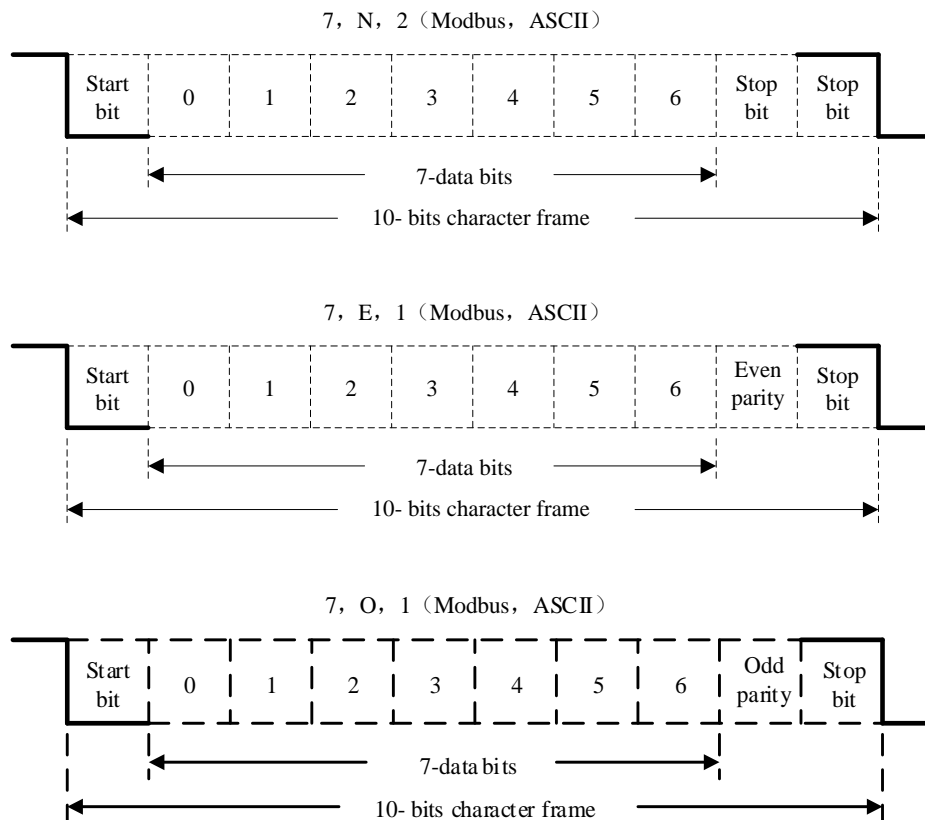

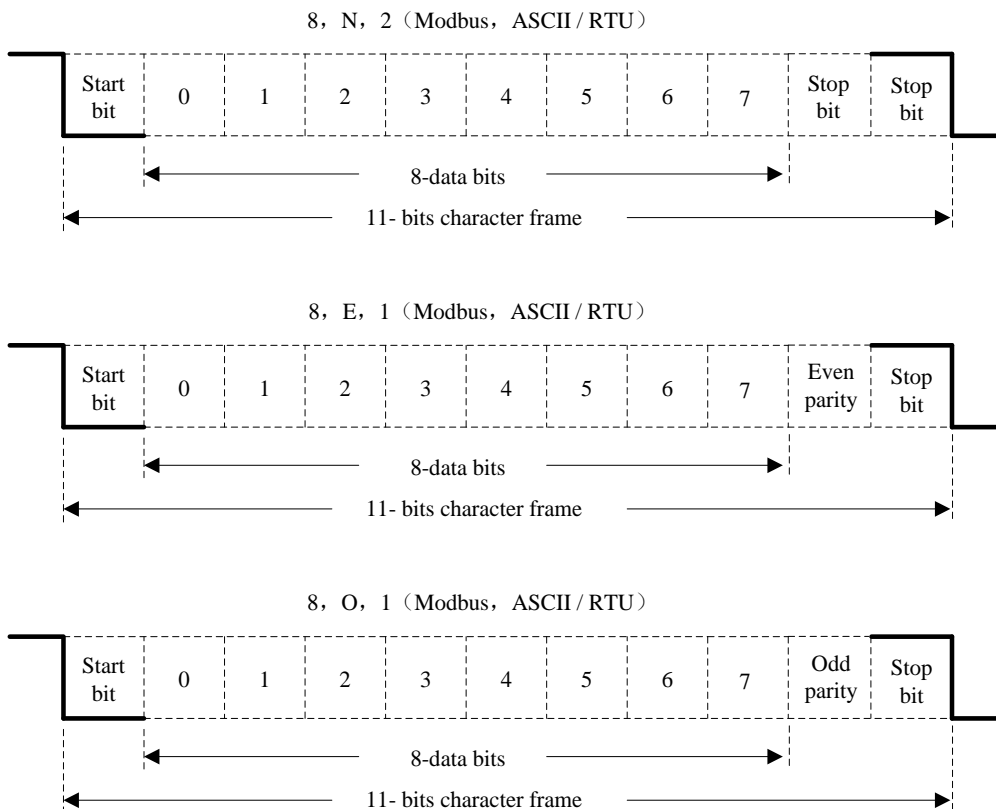
11 bit character format (for 8-bit data)

- Communication data structure

ASCII mode:

STX	Beginning character ':' =>(3A _H)
ADR	Communication address => 1-byte includes 2 ASCII codes
CMD	Command code => 1-byte includes 2 ASCII codes
DATA(n-1)	Data content => n-word=2n-byte includes 4n ASCII codes (n ≤ 12)
...	
DATA(0)	
LRC	Check code => 1-byte includes 2 ASCII codes
End 1	End code 1 => (0D _H) (CR)
End 0	End code 0 => (0A _H) (LF)

RTU mode:

STX	Rest time of at least four-byte transmission time
ADR	Communication address => 1-byte
CMD	Command code => 1-byte
DATA(n-1)	Data content => n-word=2n-byte, n ≤ 12
...	
DATA(0)	
CRC	CRC code => 1-byte
End 1	Rest time of at least four-byte transmission time

Data format of communication protocol is described as follows:

STX (Communication starting)

ASCII mode: ':' character.

RTU mode: rest time of communication time (automatically changed based on different communication speed) for more than 4 bytes.

ADR (Communication address)

Legal communication address ranges from 1 to 254.

For example, communication for servo with address of 32 (sexadecimal 20):

ASCII mode: ADR='2', '0'=>'2'=32_H, '0'=30_H

RTU mode: ADR=20_H

CMD (Command) and DATA (Data)

Data format is determined based on command code. Common command codes are as follows:

Command code: 03_H, read N word (maximum of N is 20).

For example: Read 2 words from the starting address 0200_H in the servo with address of 01_H.

ASCII mode:

Command information

STX	':'
ADR	'0'
	'1'
CMD	'0'
	'3'
Starting data position	'0'
	'2'
	'0'
	'0'
Number of data	'0'
	'0'
	'0'
	'2'
LCR Check	'F'
	'8'
End 1	(0DH)(CR)
End 0	(0AH)(LF)

Respond information

STX	':'
ADR	'0'
	'1'
CMD	'0'
	'3'
Number of data (calculated by byte)	'0'
	'4'
Content of starting data address (0200H)	'0'
	'B'
	'1'
Content of second data address (0201H)	'1'
	'F'
	'4'
LCR Check	'0'
	'E'
LCR Check	'8'
End 1	(0DH)(CR)
End 0	(0AH)(LF)

RTU mode:**Command information**

ADR	01H
CMD	03H
Starting data position	02H(high byte)
	00H(low byte)
Number of data (calculated by word)	00H
	02H
CRC Check Low	C5H(low byte)
CRC Check High	B3H(high byte)

Respond information

ADR	01H
CMD	03H
Number of data (calculated by byte)	04H
Content of starting data address (0200H)	00H(high byte)
	B1H(low byte)
Content of second data address (0201H)	1FH(high byte)
	40H(low byte)
CRC Check Low	A3H(low byte)
CRC Check High	D4H(high byte)

Command code: 06_H, write in 1 word

For example: write 100(0064_H) in address 0200_H of servo with office number 01_H.

ASCII mode:**Command information**

STX	‘.’
ADR	‘0’
	‘1’
CMD	‘0’
	‘6’
Starting data position	‘0’
	‘2’
	‘0’
	‘0’
Content of data	‘0’
	‘0’
	‘6’
	‘4’
LCR Check	‘9’
	‘3’
End 1	(0DH)(CR)
End 0	(0AH)(LF)

Respond information

STX	‘.’
ADR	‘0’
	‘1’
CMD	‘0’
	‘6’
Starting data position	‘0’
	‘2’
	‘0’
	‘0’
Content of data	‘0’
	‘0’
	‘6’
	‘4’
LCR Check	‘9’
	‘3’
End 1	(0DH)(CR)
End 0	(0AH)(LF)

RTU mode:**Command information**

ADR	01H
CMD	06H
Starting data position	02H(high byte)
	00H(low byte)
Content of data	00H(high byte)
	64H(low byte)
CRC Check Low	89H(low byte)
CRC Check High	99H(high byte)

Respond information

ADR	01H
CMD	06H
Starting data position	02H(high byte)
	00H(low byte)
Content of data	00H(high byte)
	64H(low byte)
CRC Check Low	89H(low byte)
CRC Check High	99H(high byte)

Calculation of detection error values of LRC (ASCII mode) and CRC (RTU mode):

LRC calculation of ASCII mode:

ASCII mode adopts LRC (Longitudinal Redunancy Check) detection error value. LRC detection error value is the sum of contents from ADR to the last data and the result is in the unit of 256 and removes exceeding part (for example, the result after totaling is hexadecimal 128_H and 28_H is then obtained), and then calculates its complement; thus the obtained results is the LRC detection error value.

For example, read 1 word from 0201 address of servo with official number 01_H.

STX	‘:’
ADR	‘0’
	‘1’
CMD	‘0’
	‘3’
Starting data position	‘0’
	‘2’
	‘0’
	‘1’
Number of data	‘0’
	‘0’
	‘0’
	‘1’
LCR Check	‘F’
	‘8’
End 1	(0DH)(CR)
End 0	(0AH)(LF)

Add from ADR data to the last data:

$01_{\text{H}} + 03_{\text{H}} + 02_{\text{H}} + 01_{\text{H}} + 00_{\text{H}} + 01_{\text{H}} = 08_{\text{H}}$, 08_{H} becomes $F8_{\text{H}}$ after applying complement of 2, so LRC is ‘F’, ‘8’.

CRC calculation of RTU mode:

RTU mode adopts CRC (Cyclical Redundancy Check) detection error value.

Steps for calculation of CRC detection error value are as follows:

Step 1: download a 16-bit register with content of FFFF_H (called as "CRC" register).

Step 2: conduct XOR operation on the first bit (bit0) of command message and the low order bit (LSB) of 16-bit CRC register, and save the result to CRC register;

Step 3: check the lowest order (LSB) of CRC register; if it is 0, right shift CRC register value a bit; if it is 1, right shift CRC register value a bit and then conduct XOR operation with A001_H;

Step 4: return to Step 3, until 8 times of execution of Step 3, and then move to Step 5;

Step 5: repeat Step 2-4 for the next bit of the command message, until all bits are processed; the content of CRC register now is CRC detection error value.

Note: after CRC detection error value is calculated, it is necessary to fill the CRC low order in the command message and then CRC high order. Please refer to the following example.

For example: read 2 words from 0101_H address of servo with official number of 01_H. The final content of CRC register calculated from ADR to the last bit of the data number is 3794_H, and then its command message is as shown below. Note that 94_H is transmitted prior to 37_H.

ADR	01 _H
CMD	03 _H
Starting data address	01 _H (address high order)
	01 _H (address low order)
Data number (Calculated based on word)	00 _H (high order)
	02 _H (low order)
CRC check low order	94 _H (check low order)
CRC check high order	37 _H (check high order)

End1, End0 (communication detection completed)

ASCII mode:

(0D_H) (i.e. character '\r' [carriage return]) and (0A_H) (i.e. '\n' [new line]) indicate end of communication.

RTU mode:

Exceeding the rest time of 4-byte communication time at the current communication rate indicates the end of communication.

Example:

The following uses C programming language to generate CRC value. The function needs two parameters:

```
unsigned char * data;
```

```
unsigned char length;
```

```
/*The function will pass back the CRC value in unsigned integer type.*/
```

```
unsigned int crc_chk(unsigned char * data,unsigned char length){
```

```
    int i,j;
```

```
    unsigned int crc_reg = 0xFFFF;
```

```
    while(length- -){
```

```
        crc_reg ^=*data++;
```

```
        for(j=0;j<8;j++){
```

```

        if(crc_reg & 0x01){
            crc_reg=( crc_reg >>1)^0xA001;
        }
        Else
        {
            crc_reg=crc_reg >>1;
        }
    }
}
return crc_reg;
}

```

■ Communication error

During communication, errors are possible, and common error sources are as follows:

- During parameters reading and writing, data address is wrong;
- During writing of a parameter, the data exceed the maximum of the parameter or are smaller than the parameter;
- Communication is interrupted, data transmission is wrong or check code is wrong.

In case of the first two communication errors, operation of servo drive will not be affected and meanwhile the servo drive will feedback an error frame. In case of the third error, transmitted data will be considered to be invalid and abandoned, without feedback of frame.

Error frame format is as follows:

Upper computer data frame:

start	Slave station address	Command	Data address, data, etc.	Check
		Command		

Servo drive feedbacks error frame:

start	Slave station address	Response code	Error code	Check
		Command + 80 _H		

Where the error frame response code = command + 80_H;

Error code = 00_H; communication is normal;

= 01_H: servo drive fails to identify the requested function;

= 02_H: data address given in request does not exist in servo drive;

= 03_H: data address given in request is not allowed in servo drive (due to exceeding the maximum or minimum value of parameter);

= 04_H: servo drive has started to execute request, but fails to complete the request;

For example: the axis number of servo drive is 03_H and datum 06_H is written in parameter Pn100; since the range of parameter Pn100 is 0-6, the written data will not be allowed and the servo drive will return a error frame, with error code of 03_H (exceeding the maximum or minimum value of parameter) and the structure as below:

Upper computer data frame:

start	Slave station address	Command	Data address, data, etc.	Check
	03 _H	06 _H	0002 _H 0006 _H	

Servo drive feedbacks error frame:

start	Slave station address	Response code	Error code	Check
	03 _H	86 _H	03 _H	

In addition, if the slave station address in data frame sent by upper computer is 00_H, indicate that the data of the frame are broadcast data and the servo drive will not return any frame.

6.4 MODBUS Communication Address

Communication data address	Meaning	Instruction	Operation
Hexadecimal system			
0000 _h ~ 03FF _h	Parameter area	Correspond to parameters in parameter table	Read and write
0400 _h ~ 0409 _h	Alarm information storage area	10 history alarms	Read only
0410 _h	Speed reference zero offset		Read only
0411 _h	Torque reference zero offset		Read only
0412 _h	Iu zero offset		Read only
0413 _h	Iv zero offset		Read only
0420 _h ~ 0437 _h	Monitoring data		Read only
0420 _h	Motor speed	Unit: 1 r/min	Read only
0422 _h	Rotation angle (electric angle)	Unit: 1deg	Read only
0424 _h	Input reference pulse speed	Unit: 1kHz	Read only
0426 _h	Bus voltage	Unit: 1 V	Read only
0428 _h	Speed reference value of analogue input	Unit: 1 r/min	Read only
042A _h	Analog input torque reference percent	Unit: 1%	Read only
042C _h	Internal torque reference percent	Unit: 1% or 0.1A	Read only
042E _h	Input signal monitoring	—	Read only
0430 _h	Output signal monitoring	—	Read only
0432 _h	Encoder signal monitoring	—	Read only
0434 _h	Input reference pulse counter	Unit: 1 reference pulse	Read only
0436 _h	Feedback pulse counter	Unit: 1 reference pulse	Read only
0438 _h	Position error counter	Unit: 1 reference pulse	Read only
043A _h	Accumulated load	Unit: 1%	Read only

Communication data address	Meaning	Instruction	Operation
Hexadecimal system			
043C _h	Rotational inertia percent	Unit: 1%	Read only
043E _h	Actual angle of encoder	Unit: 1 reference pulse	Read only
0440 _h	Encoder multi-circle position	Unit: 1 circle	Read only
044A _h	Current alarm		Read only
0451 _h	Communication IO signal *1	Power failure not saved	Read and write
0452 _h	Communication output port reverse	Power failure not saved	Read and write
0457 _h	Servo operation status *2		Read only
045E _h	Software version		Read only
045F _h	FPGA version number		Read only
0520 _h	Clear history alarm	1: Clear history alarm	Read and write
0521 _h	Clear current alarm	1: Clear current alarm	Read and write
0522 _h	Clear bus encoder alarm	1: Clear bus encoder alarm	Read and write
0523 _h	Clear bus encoder multi-circle data	1: Clear bus encoder multi-circle data	Read and write
0528 _h	Speed JOG (speed as set in P□304)	BIT15:1 JOG servo enable BIT01:1 JOG- (JOG positive) BIT00:1 JOG+ (JOG negative)	Read and write
0529 _h	Position JOG (speed as set in P□304)	BIT15:1 Enter position jog mode BIT01:1 JOG- BIT00:1 JOG+	Read and write
0540 _h	Factory reset	1: Factory reset	Writable
0541 _h	Reset	1: Reset	Writable
05F0 _h	Number of data set under operation		Read only
05F1 _h	Number of data set to be operated		Read only
05F2 _h	Actual position is 16 bits lower	Position contacts position after electronic gear	Read only
05F3 _h	Actual position is 16 bits higher		Read only
05F4 _h	Position node manner	0: Task 1: External	Read only
05F5 _h	Acceleration	10rpm/s/s	Read and write
05F6 _h	Deceleration	10rpm/s/s	Read and write
05F7 _h	Emergency deceleration	10rpm/s/s	Read and write

Communication data address	Meaning	Instruction	Operation
Hexadecimal system			
05F8_h	Position contact electronic gear numerator		Read and write
05F9_h	Position contact electronic gear denominator		Read and write
05FA_h	Reference point seeking manner		Read and write
05FB_h	Reference point seeking on-off speed	0~6000 rpm	Read and write
05FC_h	On-off speed to leave reference point	0~6000 rpm	Read and write
05FD_h	Demonstration position low byte		Read and write
05FE_h	Demonstration position high byte		Read and write
Data set 0 parameter:			
0600 h	Destination position low byte		Read and write
0601 h	Destination position high byte		Read and write
0602 h	Target speed	rpm	Read and write
0603 h	Step change attribute *3		Read and write
0604 h	Step change condition 1 value		Read and write
0605 h	Step change condition 2 value		Read and write
0606 h	Subsequent data set number		Read and write
0607 h	Data set type	0: NULL; 1: Absolute; 2: Relative	Read and write
Data set 1 parameter:			
0608_h	Destination position low byte		Read and write
0609_h	Destination position high byte		Read and write
060A_h	Target speed	rpm	Read and write
060B_h	Step change condition attribute		Read and write
060C_h	Step change condition 1 value		Read and write
060D_h	Step change condition 2 value		Read and write
060E_h	Subsequent data set number		Read and write
060F_h	Data set type	0: NULL; 1: Absolute; 2: Relative	Read and write
Data set 2 parameter:			
0610 h	Destination position low byte		Read and write
0611 h	Destination position high byte		Read and write
0612 h	Target speed	rpm	Read and write
0613 h	Step change condition attribute		Read and write

Communication data address	Meaning	Instruction	Operation
Hexadecimal system			
0614 h	Step change condition 1 value		Read and write
0615 h	Step change condition 2 value		Read and write
0616 h	Subsequent data set number		Read and write
0617 h	Data set type	0: NULL; 1: Absolute; 2: Relative	Read and write
Data set 3 parameter:			
0618h	Destination position low byte		Read and write
0619h	Destination position high byte		Read and write
061Ah	Target speed	rpm	Read and write
061Bh	Step change condition attribute		Read and write
061Ch	Step change condition 1 value		Read and write
061Dh	Step change condition 2 value		Read and write
061Eh	Subsequent data set number		Read and write
061Fh	Data set type	0: NULL; 1: Absolute; 2: Relative	Read and write
Data set 4 parameter:			
0620h	Destination position low byte		Read and write
0621h	Destination position high byte		Read and write
0622h	Target speed	rpm	Read and write
0623h	Step change condition attribute		Read and write
0624h	Step change condition 1 value		Read and write
0625h	Step change condition 2 value		Read and write
0626h	Subsequent data set number		Read and write
0627h	Data set type	0: NULL; 1: Absolute; 2: Relative	Read and write
Data set 5 parameter:			
0628h	Destination position low byte		Read and write
0629h	Destination position high byte		Read and write
062Ah	Target speed	rpm	Read and write
062Bh	Step change condition attribute		Read and write
062Ch	Step change condition 1 value		Read and write
062Dh	Step change condition 2 value		Read and write
062Eh	Subsequent data set number		Read and write
062Fh	Data set type	0: NULL; 1: Absolute; 2: Relative	Read and write

Communication data address	Meaning	Instruction	Operation
Hexadecimal system			
Data set 6 parameter:			
0630_h	Destination position low byte		Read and write
0631_h	Destination position high byte		Read and write
0632_h	Target speed	rpm	Read and write
0633_h	Step change condition attribute		Read and write
0634_h	Step change condition 1 value		Read and write
0635_h	Step change condition 2 value		Read and write
0636_h	Subsequent data set number		Read and write
0637_h	Data set type	0: NULL; 1: Absolute; 2: Relative	Read and write
Data set 7 parameter:			
0638_h	Destination position low byte		Read and write
0639_h	Destination position high byte		Read and write
063A_h	Target speed	rpm	Read and write
063B_h	Step change condition attribute		Read and write
063C_h	Step change condition 1 value		Read and write
063D_h	Step change condition 2 value		Read and write
063E_h	Subsequent data set number		Read and write
063F_h	Data set type	0: NULL; 1: Absolute; 2: Relative	Read and write
Data set 8 parameter:			
0640_h	Destination position low byte		Read and write
0641_h	Destination position high byte		Read and write
0642_h	Target speed	rpm	Read and write
0643_h	Step change condition attribute		Read and write
0644_h	Step change condition 1 value		Read and write
0645_h	Step change condition 2 value		Read and write
0646_h	Subsequent data set number		Read and write
0647_h	Data set type	0: NULL; 1: Absolute; 2: Relative	Read and write
Data set 9 parameter:			
0648_h	Destination position low byte		Read and write
0649_h	Destination position high byte		Read and write
064A_h	Target speed	rpm	Read and write
064B_h	Step change condition attribute		Read and write
064C_h	Step change condition 1 value		Read and write

Communication data address	Meaning	Instruction	Operation
Hexadecimal system			
064D_h	Step change condition 2 value		Read and write
064E_h	Subsequent data set number		Read and write
064F_h	Data set type	0: NULL; 1: Absolute; 2: Relative	Read and write
Data set 10 parameter:			
0650_h	Destination position low byte		Read and write
0651_h	Destination position high byte		Read and write
0652_h	Target speed	rpm	Read and write
0653_h	Step change condition attribute		Read and write
0654_h	Step change condition 1 value		Read and write
0655_h	Step change condition 2 value		Read and write
0656_h	Subsequent data set number		Read and write
0657_h	Data set type	0: NULL; 1: Absolute; 2: Relative	Read and write
Data set 11 parameter:			
0658_h	Destination position low byte		Read and write
0659_h	Destination position high byte		Read and write
065A_h	Target speed	rpm	Read and write
065B_h	Step change condition attribute		Read and write
065C_h	Step change condition 1 value		Read and write
065D_h	Step change condition 2 value		Read and write
065E_h	Subsequent data set number		Read and write
065F_h	Data set type	0: NULL; 1: Absolute; 2: Relative	Read and write
Data set 12 parameter:			
0660_h	Destination position low byte		Read and write
0661_h	Destination position high byte		Read and write
0662_h	Target speed	rpm	Read and write
0663_h	Step change condition attribute		Read and write
0664_h	Step change condition 1 value		Read and write
0665_h	Step change condition 2 value		Read and write
0666_h	Subsequent data set number		Read and write
0667_h	Data set type	0: NULL; 1: Absolute; 2: Relative	Read and write
Data set 13 parameter:			

Communication data address	Meaning	Instruction	Operation
Hexadecimal system			
0668h	Destination position low byte		Read and write
0669h	Destination position high byte		Read and write
066Ah	Target speed	rpm	Read and write
066Bh	Step change condition attribute		Read and write
066Ch	Step change condition 1 value		Read and write
066Dh	Step change condition 2 value		Read and write
066Eh	Subsequent data set number		Read and write
066Fh	Data set type	0: NULL; 1: Absolute; 2: Relative	Read and write
Data set 14 parameter:			
0670h	Destination position low byte		Read and write
0671h	Destination position high byte		Read and write
0672h	Target speed	rpm	Read and write
0673h	Step change condition attribute		Read and write
0674h	Step change condition 1 value		Read and write
0675h	Step change condition 2 value		Read and write
0676h	Subsequent data set number		Read and write
0677h	Data set type	0: NULL; 1: Absolute; 2: Relative	Read and write
Data set 15 parameter:			
0678h	Destination position low byte		Read and write
0679h	Destination position high byte		Read and write
067Ah	Target speed	rpm	Read and write
067Bh	Step change condition attribute		Read and write
067Ch	Step change condition 1 value		Read and write
067Dh	Step change condition 2 value		Read and write
067Eh	Subsequent data set number		Read and write
067Fh	Data set type	0: NULL; 1: Absolute; 2: Relative	Read and write
Data set 16 parameter:			
0680h	Destination position low byte		Read and write
0681h	Destination position high byte		Read and write
0682h	Target speed	rpm	Read and write
0683h	Step change condition attribute		Read and write
0684h	Step change condition 1 value		Read and write
0685h	Step change condition 2 value		Read and write

Communication data address	Meaning	Instruction	Operation
Hexadecimal system			
0686_h	Subsequent data set number		Read and write
0687_h	Data set type	0: NULL; 1: Absolute; 2: Relative	Read and write
Data set 17 parameter:			
0688_h	Destination position low byte		Read and write
0689_h	Destination position high byte		Read and write
068A_h	Target speed	rpm	Read and write
068B_h	Step change condition attribute		Read and write
068C_h	Step change condition 1 value		Read and write
068D_h	Step change condition 2 value		Read and write
068E_h	Subsequent data set number		Read and write
068F_h	Data set type	0: NULL; 1: Absolute; 2: Relative	Read and write
Data set 18 parameter:			
0690_h	Destination position low byte		Read and write
0691_h	Destination position high byte		Read and write
0692_h	Target speed	rpm	Read and write
0693_h	Step change condition attribute		Read and write
0694_h	Step change condition 1 value		Read and write
0695_h	Step change condition 2 value		Read and write
0696_h	Subsequent data set number		Read and write
0697_h	Data set type	0: NULL; 1: Absolute; 2: Relative	Read and write
Data set 19 parameter:			
0698_h	Destination position low byte		Read and write
0699_h	Destination position high byte		Read and write
069A_h	Target speed	rpm	Read and write
069B_h	Step change condition attribute		Read and write
069C_h	Step change condition 1 value		Read and write
069D_h	Step change condition 2 value		Read and write
069E_h	Subsequent data set number		Read and write
069F_h	Data set type	0: NULL; 1: Absolute; 2: Relative	Read and write
Data set 20 parameter:			
06A0_h	Destination position low byte		Read and write

Communication data address	Meaning	Instruction	Operation
Hexadecimal system			
06A1_h	Destination position high byte		Read and write
06A2_h	Target speed	rpm	Read and write
06A3_h	Step change condition attribute		Read and write
06A4_h	Step change condition 1 value		Read and write
06A5_h	Step change condition 2 value		Read and write
06A6_h	Subsequent data set number		Read and write
06A7_h	Data set type	0: NULL; 1: Absolute; 2: Relative	Read and write
Data set 21 parameter:			
06A8_h	Destination position low byte		Read and write
06A9_h	Destination position high byte		Read and write
06AA_h	Target speed	rpm	Read and write
06AB_h	Step change condition attribute		Read and write
06AC_h	Step change condition 1 value		Read and write
06AD_h	Step change condition 2 value		Read and write
06AE_h	Subsequent data set number		Read and write
06AF_h	Data set type	0: NULL; 1: Absolute; 2: Relative	Read and write
Data set 22 parameter:			
06B0_h	Destination position low byte		Read and write
06B1_h	Destination position high byte		Read and write
06B2_h	Target speed	rpm	Read and write
06B3_h	Step change condition attribute		Read and write
06B4_h	Step change condition 1 value		Read and write
06B5_h	Step change condition 2 value		Read and write
06B6_h	Subsequent data set number		Read and write
06B7_h	Data set type	0: NULL; 1: Absolute; 2: Relative	Read and write
Data set 23 parameter:			
06B8_h	Destination position low byte		Read and write
06B9_h	Destination position high byte		Read and write
06BA_h	Target speed	rpm	Read and write
06BB_h	Step change condition attribute		Read and write
06BC_h	Step change condition 1 value		Read and write
06BD_h	Step change condition 2 value		Read and write
06BE_h	Subsequent data set number		Read and write

Communication data address	Meaning	Instruction	Operation
Hexadecimal system			
06BF_h	Data set type	0: NULL; 1: Absolute; 2: Relative	Read and write
Data set 24 parameter:			
06C0_h	Destination position low byte		Read and write
06C1_h	Destination position high byte		Read and write
06C2_h	Target speed	rpm	Read and write
06C3_h	Step change condition attribute		Read and write
06C4_h	Step change condition 1 value		Read and write
06C5_h	Step change condition 2 value		Read and write
06C6_h	Subsequent data set number		Read and write
06C7_h	Data set type	0: NULL; 1: Absolute; 2: Relative	Read and write
Data set 25 parameter:			
06C8_h	Destination position low byte		Read and write
06C9_h	Destination position high byte		Read and write
06CA_h	Target speed	rpm	Read and write
06CB_h	Step change condition attribute		Read and write
06CC_h	Step change condition 1 value		Read and write
06CD_h	Step change condition 2 value		Read and write
06CE_h	Subsequent data set number		Read and write
06CF_h	Data set type	0: NULL; 1: Absolute; 2: Relative	Read and write
Data set 26 parameter:			
06D0_h	Destination position low byte		Read and write
06D1_h	Destination position high byte		Read and write
06D2_h	Target speed	rpm	Read and write
06D3_h	Step change condition attribute		Read and write
06D4_h	Step change condition 1 value		Read and write
06D5_h	Step change condition 2 value		Read and write
06D6_h	Subsequent data set number		Read and write
06D7_h	Data set type	0: NULL; 1: Absolute; 2: Relative	Read and write
Data set 27 parameter:			
06D8_h	Destination position low byte		Read and write
06D9_h	Destination position high byte		Read and write

Communication data address	Meaning	Instruction	Operation
Hexadecimal system			
06DA_h	Target speed	rpm	Read and write
06DB_h	Step change condition attribute		Read and write
06DC_h	Step change condition 1 value		Read and write
06DD_h	Step change condition 2 value		Read and write
06DE_h	Subsequent data set number		Read and write
06DF_h	Data set type	0: NULL; 1: Absolute; 2: Relative	Read and write
Data set 28 parameter:			
06E0_h	Destination position low byte		Read and write
06E1_h	Destination position high byte		Read and write
06E2_h	Target speed	rpm	Read and write
06E3_h	Step change condition attribute		Read and write
06E4_h	Step change condition 1 value		Read and write
06E5_h	Step change condition 2 value		Read and write
06E6_h	Subsequent data set number		Read and write
06E7_h	Data set type	0: NULL; 1: Absolute; 2: Relative	Read and write
Data set 29 parameter:			
06E8_h	Destination position low byte		Read and write
06E9_h	Destination position high byte		Read and write
06EA_h	Target speed	rpm	Read and write
06EB_h	Step change condition attribute		Read and write
06EC_h	Step change condition 1 value		Read and write
06ED_h	Step change condition 2 value		Read and write
06EE_h	Subsequent data set number		Read and write
06EF_h	Data set type	0: NULL; 1: Absolute; 2: Relative	Read and write
Data set 30 parameter:			
06F0_h	Destination position low byte		Read and write
06F1_h	Destination position high byte		Read and write
06F2_h	Target speed	rpm	Read and write
06F3_h	Step change condition attribute		Read and write
06F4_h	Step change condition 1 value		Read and write
06F5_h	Step change condition 2 value		Read and write
06F6_h	Subsequent data set number		Read and write
06F7_h	Data set type	0: NULL; 1: Absolute; 2: Relative	Read and write

Communication data address	Meaning	Instruction	Operation
Hexadecimal system			
		Relative	
Data set 31 parameter:			
06F8_h	Destination position low byte		Read and write
06F9_h	Destination position high byte		Read and write
06FA_h	Target speed	rpm	Read and write
06FB_h	Step change condition attribute		Read and write
06FC_h	Step change condition 1 value		Read and write
06FD_h	Step change condition 2 value		Read and write
06FE_h	Subsequent data set number		Read and write
06FF_h	Data set type	0: NULL; 1: Absolute; 2: Relative	Read and write
Data set 32 parameter (next data set of operating data set):			
0700_h	Destination position low byte		Read and write
0701_h	Destination position high byte		Read and write
0702_h	Target speed	rpm	Read and write
0703_h	Step change condition attribute		Read and write
0704_h	Step change condition 1 value		Read and write
0705_h	Step change condition 2 value		Read and write
0706_h	Subsequent data set number		Read and write
0707_h	Data set type	0: NULL; 1: Absolute; 2: Relative	Read and write

Address description:

*1. Communication IO input (0451_h)

Input signal can be given through communication IO input (0451h) register of MODBUS communication. The definition of the register is as follows:

bit15	bit14	bit13	bit12	bit11	bit10	bit9	bit8
/START-HOME	/POS-STEP	/POS-START	/POS-REF	/POS2	/POS1	/POS0	/G-SEL
bit7	bit6	bit5	bit4	bit3	bit2	bit1	bit0
/N-CL	/P-CL	/CLR	/ALM-RST	N-OT	P-OT	/P-CON	/SON

Signal input in the register is valid only when the signal is not input from CN3 (signal distribution parameter is set to be "Null").

For example: to input /POS-START through communication IO input register, it is necessary to set P□512.1=0 first, and then modify bit13 of communication IO input (0451h) register valid.

*2. Servo operation status (0456_h)

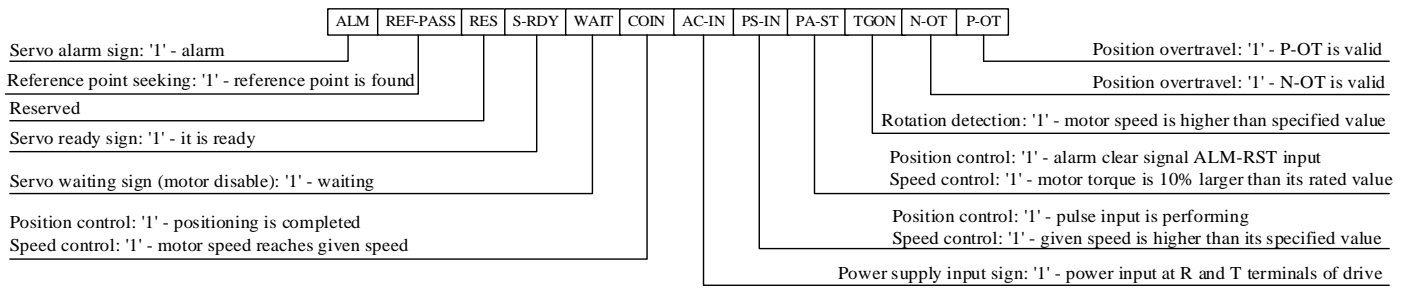

*3. Step change condition attribute

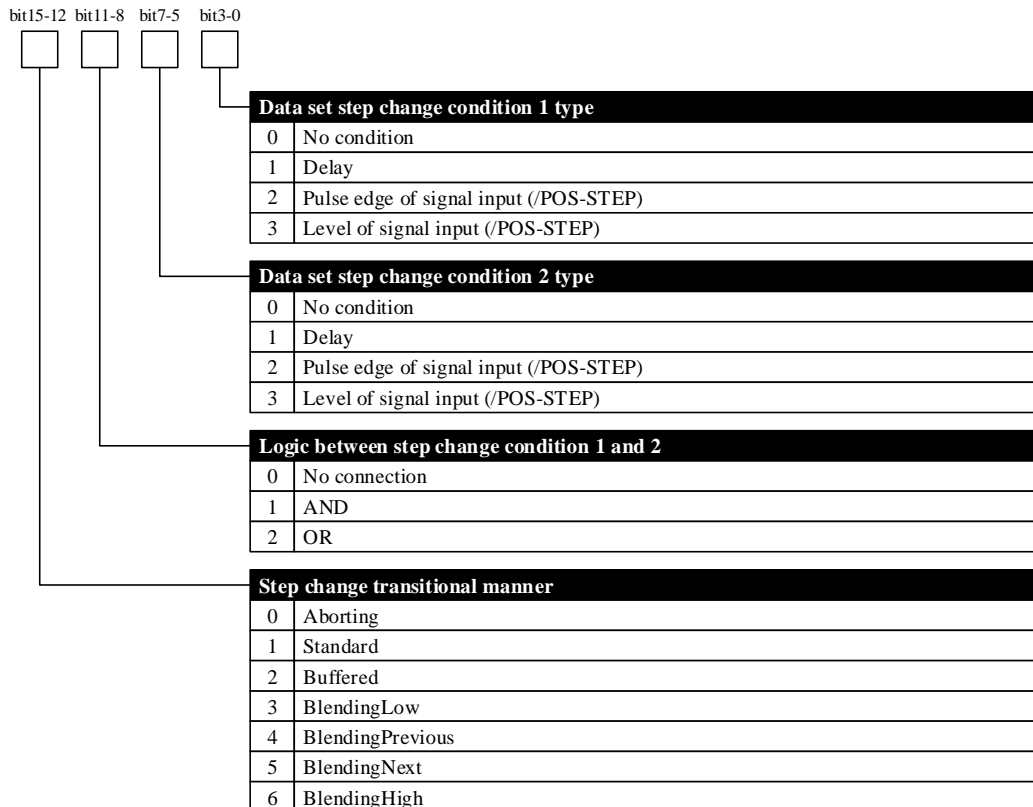

P□503	Width of same-speed detection signal			Speed
	Setting range	Setting unit	Factory setting	Power reboot
	0 ~ 100	1r/min	10	Not required

If the difference between motor speed and reference speed is smaller than the set value of P□503, then "/V-CMP" signal is output.

■For example,
At P□503=100 and reference speed of 2000 r/min, if motor speed ranges from 1900 to 2100r/min, "/V-CMP" is set to be ON.

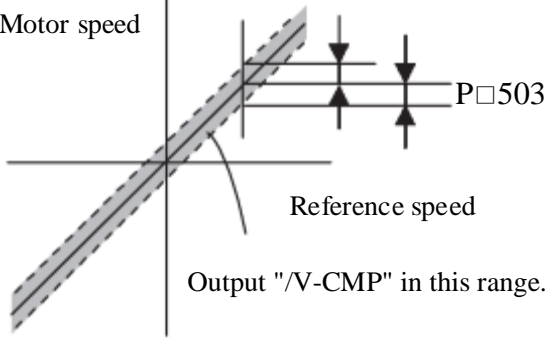

■Supplement
"/V-CMP" is the output signal under speed control. In case of position control, then the function will automatically change to "/COIN"; in case of torque control, it will automatically change to "OFF(H level)".

Chapter VII Maintenance and Inspection

7.1 Abnormality Diagnosis and Treatment Methods

7.1.1 Overview of Alarm Display

Relationship between alarm display and alarm code output ON/OFF is as shown in the table below. The method to stop motor in case of alarm: free-running stop: without braking, natural stop by friction resistance at the time of motor rotation.

Alarm display	ALM output	Alarms	Alarm contents	Clear or not
□01	H	Encoder PA, PB, PC disconnection	Encoder disconnection or cable welding problem.	Clear
□02	H	Encoder PU, PV, PW disconnection	Encoder disconnection or cable welding problem.	Clear
□03	H	Overload	Continuous running at a certain torque exceeding the rated value	Clear
□04	H	A/D switch channel abnormal	A/D switch channel abnormal	Clear
□05	H	PU, PV, PW false code	PU, PV, PW signals are all high or low	Clear
□06	H	PU, PV, PW phases incorrect	PU, PV, PW signals are all high or low	Clear
□10	H	Overcurrent	Servo drive IPM module current is overlarge.	Clear
□11	H	Overvoltage	Servo drive main circuit voltage is too high.	No
□12	H	Undervoltage	Servo drive main circuit voltage is too low.	No
□13	H	Parameter damage	EEROM data in servo drive is abnormal.	Clear
□14	H	Over-speed	Servo motor speed is extremely high	Clear
□15	H	Deviation counter overflow	Internal position deviation counter overflow	Clear
□16	H	Position deviation is overlarge	Position deviation pulse exceeds the set value of parameter P□504.	Clear
□17	H	Electronic gear fault	Electronic gear is unreasonably set or pulse frequency is too high	Clear
□18	H	1st channel of current detection is abnormal	Current detection abnormal	Clear
□19	H	2nd channel of current detection is abnormal	Current detection abnormal	Clear
□22	H	Motor model is incorrect	Servo drive parameters do not match with those of motor	Clear
□23	H	Servo drive does not match with motor	Servo drive does not match with motor	Clear
□25	H	Bus encoder multi-circle information error	Multi- circle information error	Clear
□26	H	Bus encoder multi-circle information overflow	Multi- circle information overflow	Clear
□27	H	Bus encoder battery alarm 1	Battery voltage is lower than 2.5 V, multi-circle information is lost	Clear
□28	H	Bus encoder battery alarm 2	Battery voltage is lower than 3.1 V, battery voltage is relatively low	Clear

Alarm display	ALM output	Alarms	Alarm contents	Clear or not
□30	H	Bleeder resistor disconnection alarm	Braking resistor damage.	Clear
□31	H	Regeneration overload	Regeneration processing circuit is abnormal.	No
□33	H	Momentary outage alarm.	There is outage of over one power cycle under AC current.	Clear
□34	H	Rotary transformer is abnormal	Rotary transformer communication is abnormal.	Clear
□40	H	Bus encoder communication is abnormal	Servo drive and encoder cannot realize communication.	Clear
□41	H	Bus encoder overspeed	When power is ON, encoder rotates at high speed	Clear
□42	H	Bus encoder absolute status error	Encoder damage or encoder decoding circuit damage	Clear
□43	H	Bus encoder counting error	Encoder damage or encoder decoding circuit damage	Clear
□44	H	Check error in bus encoder control field	Encoder signal is interrupted or encoder decoding circuit damage	Clear
□45	H	Check error in bus encoder communication data	Encoder signal is interrupted or encoder decoding circuit damage	Clear
□46	H	Stop bit error in bus encoder status field	Encoder signal is interrupted or encoder decoding circuit damage	Clear
□47	H	Stop bit error in bus encoder SFOME	Encoder signal is interrupted or encoder decoding circuit damage	Clear
□48	H	Bus encoder data are not initialized	Bus encoder SFOME data are null	Clear
□49	H	Sum check error in bus encoder data	Sum check in bus encoder EEPROM data is abnormal	Clear
□60	H	MODBUS communication timeout	Drive fails to accept data normally at the set time in P□602	Clear
□61	H	CANopen master station heartbeat timeout	Drive fails to accept master station heartbeat message normally at the set time	Clear
□70	H	Drive overheat alarm	Drive internal IPM module temperature is too high	Clear
□90	H	Software does not match with hardware	Parameter is wrongly set or software does not match with hardware	No
□--	L	No error display	Display normal action status	Clear

Note:

1. "□" in alarm display may be "A" or "b", referring to A axis alarm or b axis alarm respectively.
2. Alarms of □25, □26, □27, □41 can be reset only after alarms in encoder is cleared through auxiliary function mode.

7.1.2 Alarm Displays and Their Causes and Treatment Measures

In case of abnormalities of the servo drive, the panel operator will display alarm information of A□□ or b□□. Alarm displays and their treatment measures are as follows:

If the abnormal condition still exists after treatment, please contact with service department of our company.

(1) List of alarm displays

Alarm	Alarm contents	Circumstance	Cause	Treatment measures
□01	Incremental encoder ABC disconnects	When power supply is on or during operation	Wiring of encoder is wrong	Correct wiring of encoder
			Encoder cables are interfered due to different specifications	Change cable specifications to stranded wire or stranded shielded wire with core wire over 0.12 mm ² and stranded wire made of tinned soft copper
			Encoder cables are interfered due to overlength	The max. wiring distance should be 20 m.
			Signal lines are interfered due to engaging-in and damage in sheath of encoder cables	Correct layout of encoder cables
			Encoder cables are bound with high current line or their distance is too close	Lay encoder cables at places free from surge voltage
			Change in FG potential due to influence by motor side equipment (welding machine, etc.)	Connect equipment ground wire to prevent shunting to FG at PG side
			Signal line of encoder is interfered	Take anti-interference measures for encoder wiring.
			Encoder failure	Replace servo motor
			Servo drive circuit board develops fault	Replace the servo drive
□02	Incremental encoder UVW disconnects	When power supply is on or during operation	Wiring of encoder is wrong	Correct wiring of encoder
			Encoder cables are interfered due to different specifications	Change cable specifications to stranded wire or stranded shielded wire
			Encoder cables are interfered due to overlength	The max. wiring distance should be 20 m.
			Signal lines are interfered due to engaging-in and damage in sheath of encoder cables	Correct layout of encoder cables
			Encoder cables are bound with high current line or their distance is too close	Lay encoder cables at places free from surge voltage
			Change in FG potential due to influence by motor side equipment (welding machine, etc.)	Connect equipment ground wire to prevent shunting to FG at PG side
			Signal line of encoder is interfered	Take anti-interference measures for encoder wiring.
			Encoder failure	Replace servo motor
			Servo drive circuit board develops fault	Replace the servo drive
□03	Overload	When control power supply is on	Servo drive circuit board develops fault	Replace the servo drive
		During servo ON	Motor wiring is abnormal (poor condition in wiring and connection)	Revise motor wiring
			Encoder wiring is abnormal (poor wiring and connection)	Correct wiring of encoder

Alarm	Alarm contents	Circumstance	Cause	Treatment measures
		When the servo motor fails to rotate during inputting of commands	Servo drive circuit board develops fault	Replace the servo drive
			Motor wiring is abnormal (poor condition in wiring and connection)	Revise motor wiring
			Encoder wiring is abnormal (poor wiring and connection)	Correct wiring of encoder
			Starting torque exceeds the max. torque	Review loading condition, operation condition or motor capacity
			Servo drive circuit board develops fault	Replace the servo drive
		Normally during operation	Effective torque exceeds rated torque or starting torque exceeds rated torque substantially	Review loading condition, operation condition or motor capacity
			Temperature within storage tray of the servo drive is high	Reduce the temperature within storage tray below 55°
			Servo drive circuit board develops fault	Replace the servo drive
		□05	Incremental encoder UVW signal is abnormal	When control power supply is on
Encoder failure	Replace servo motor			
Servo drive circuit board develops fault	Replace the servo drive			
□10	Overcurrent	When control power supply is on	Overload alarm reset for several times due to power off	Change reset method of alarms
			Servo drive circuit board develops fault	Replace the servo drive
		When main power circuit is on or overcurrent during motor operation	A faulty connection occurs between U, V, W and ground wire.	Check wiring and connect correctly.
			Ground wire wraps around other terminals	
			A short circuit occurs between U, V, W used by main circuit of motor and ground wire	Revise or replace the cables used by main circuit of motor
			A short circuit occurs between U, V, and W used by main circuit of motor	
			An error occurs to regenerative resistor wiring.	Check wiring and connect correctly.
			A short circuit occurs between U, V, W of the servo drive and ground wire	Replace the servo drive
			Servo drive develops fault (current feedback circuit, power transistor or circuit board fault)	
			A short circuit occurs between U, V, W used by main circuit of motor and ground wire	Replace servo motor
			A short circuit occurs between U, V, and W used by main circuit of motor	
			Overload alarm reset for several times due to power off	Change reset method of alarms
Position speed reference changes violently	Re-evaluate reference value.			
Whether the load is too much and whether	Review loading condition and			

Alarm	Alarm contents	Circumstance	Cause	Treatment measures
			regeneration handling capacity is exceeded	operation condition (check specifications of inertia of load)
			The installation (direction, interval with other parts) of servo drive is improper (whether there is storage disk is releasing heat while the surrounding is heating)	Reduce ambient temperature of the servo drive to below 55 °C
			Encoder slips	Replace servo motor
			Servo unit fan stops rotating	Replace the servo drive
			Servo drive circuit board develops fault	
□11	Overvoltage * Detect when main circuit power is on	When control power supply is on	Servo drive circuit board develops fault	Replace the servo drive
		When main circuit power is on	AC supply voltage is too high	Adjust AC supply voltage to normal range
			Servo drive circuit board develops fault	Replace the servo drive
		Normally during operation	Check AC supply voltage (whether voltage changes substantially)	Adjust AC supply voltage to normal range
			Number of turns is high and moment of inertia of load is too large (insufficient regeneration capacity)	Review loading condition and operation condition (check specifications of inertia of load)
		Servo drive circuit board develops fault	Replace the servo drive	
When the servo motor decelerates Occurrence	Number of turns is high and moment of inertia of load is too large	Review loading condition and operation condition		
□12	Undervoltage * Detect when main circuit power is on	When control power supply is on	Servo drive circuit board develops fault	Replace the servo drive
		When main circuit power is on	AC supply voltage is too low	Adjust AC supply voltage to normal range
			Servo unit fuse burns out	Replace the servo drive
			Limiting resistor of surge current disconnects (whether power voltage is abnormal and whether limiting resistor of surge current is overload)	Replace servo unit (confirm power voltage and reduce frequency of main circuit ON/OFF)
			Servo drive circuit board develops fault	Replace the servo drive
		Normally during operation	AC supply voltage is low (whether there is oversized voltage drop)	Adjust AC supply voltage to normal range
			Power failure occurs instantaneously.	Restart operation through reset
			Cable short circuit of motor main circuit	Revise or replace the cables used by main circuit of motor
			Servo motor short circuit	Replace servo motor
			Servo drive circuit board develops fault	Replace the servo drive
□13	Parameter damage	When control power supply is on	Power is turned off when parameters are being set	Execute user parameters initialization (F□011)

Alarm	Alarm contents	Circumstance	Cause	Treatment measures
			Power is turned off when alarm is being entered	
			Servo drive circuit board develops fault	Replace the servo drive
□14	Over-speed	When control power supply is on	Servo drive circuit board develops fault	Replace the servo drive
		During servo ON	The phase sequence of U, V and M of motor wiring is at fault	Correct motor wiring
			Wiring of encoder is wrong	Correct wiring of encoder
			Encoder wiring is malfunctioned due to interference	Take anti-interference measures for encoder wiring.
			Servo drive circuit board develops fault	Replace the servo drive
		When the servo motor starts operation or during high-speed rotation	The phase sequence of U, V and M of motor wiring is at fault	Correct motor wiring
			Wiring of encoder is wrong	Correct wiring of encoder
			Encoder wiring is malfunctioned due to interference	Take anti-interference measures for encoder wiring.
			Input value of position/speed reference is too much	Lower reference value
			Speed reference input gain setting is wrong	Correct reference input gain
			Servo drive circuit board develops fault	Replace the servo drive
		□15	Position counter overflow	When the servo motor starts operation or during high-speed rotation
Input reference frequency is abnormal	Reduce frequency of command computer			
Wiring is wrong	Correct wiring			
□16	Position error is too large (position error with servo ON exceeds user parameter overflow level P□504 setting)	When control power supply is on	Excessive position offset alarm level (P□504) is incorrect	Set value of user parameter P□504 to any value other than 0
			Servo drive circuit board develops fault	Replace the servo drive
		During high-speed rotation	Wiring of U, V and W of the servo motor is abnormal (incomplete connection)	Correct motor wiring Correct wiring of encoder
			Servo drive circuit board develops fault	Replace the servo drive
		When the servo motor fails to rotate after sending position reference	Wiring of U, V and W of the servo motor is poor	Revise motor wiring
			Servo drive circuit board develops fault	Replace the servo drive
		During long reference with normal action	Gain adjustment of servo drive is poor	Increase speed loop gain (P□100) and position loop gain (P□102)
			Position reference pulse frequency is too high	Slow reduce position reference frequency
				Add smoothing function Reassess electronic gear ratio
			Excessive position offset alarm level (P□504)	Set user parameter P□504 to

Alarm	Alarm contents	Circumstance	Cause	Treatment measures
			is incorrect	correct value
			Load conditions (torque and moment of inertia) inconsistent with motor specifications	Review reassessed load or motor capacity
□17	Electronic gear fault	When control power supply is on When the servo motor starts operation	Setting of electronic gear is incorrect	Reset P□202 and P□203
□18	1st channel of current detection is abnormal	When control power supply is on When the servo motor starts operation	Servo drive circuit board develops fault	Replace the servo drive
□19	1st channel of current detection is abnormal	When control power supply is on When the servo motor starts operation	Servo drive circuit board develops fault	Replace the servo drive
□22	Motor model is incorrect	When control power supply is on	Drive motor parameter setting is abnormal	Replace the servo drive
			Parameters written into encoder are abnormal	Replace the servo motor (encoder)
			Servo drive circuit board develops fault	Replace the servo drive
□23	Drive does not match with motor	When control power supply is on	Servo unit capacity and motor capacity are not suitable for motor capacity	Match servo unit capacity with servo motor capacity
			Parameters written into encoder are abnormal	Replace the servo motor (encoder)
			Drive motor parameter setting is abnormal	Replace the servo drive
			Servo drive circuit board develops fault	Replace the servo drive
□25	Multi-circle data of bus encoder goes wrong	When control power supply is on	Multi-circle data of absolute encoder is abnormal	Execute bus encoder multi-coil position cleanout (F□09) and bus encoder alarm register cleanout (F□010)
		During operation of servo motor		
□26	Bus encoder multi-circle data overflow	When control power supply is on	Multi-circle data of absolute encoder is abnormal	Execute bus encoder multi-coil position cleanout (F□09) and bus encoder alarm register cleanout (F□010)
		During operation of servo motor		
□27	Bus encoder battery alarm 1	When control power supply is on		
□28	Bus encoder battery alarm 2	When control power supply is on		
□30	Regeneration is abnormal	When control power supply is on	Servo drive circuit board develops fault	Replace the servo drive
		When main circuit power is on	Circumscribed regenerative resistor is not connected	Connect circumscribed regenerative resistor
			Check whether the wiring of regenerative	Revise the wiring of

Alarm	Alarm contents	Circumstance	Cause	Treatment measures
			resistor is in good condition or broken	circumscribed regenerative resistor
			Jumper wire between B2 and B3 comes off (when using built-in regenerative resistor)	Correct wiring
		Normally during operation	Check whether the wiring of regenerative resistor is in good condition or comes off	Revise the wiring of circumscribed regenerative resistor
			Regenerative resistor disconnects (whether regeneration energy is too much)	Replace regenerative resistor or servo drive (review load and operation conditions)
			Servo drive develops fault (fault in regenerative transistor and voltage detecting part)	Replace the servo drive
□31	Regeneration overload	When control power supply is on	Servo drive circuit board develops fault	Replace the servo drive
		When main circuit power is on	Power supply voltage exceeds 270 V	Correct voltage
		Normally during operation (regenerative resistor temperature increases significantly)	Regenerative energy is too much	Reselect regenerative resistor capacity or review load and operation conditions.
			Under continuous regeneration status	
		Normally during operation (regenerative resistor temperature increases slightly)	Servo drive circuit board develops fault	Replace the servo drive
		When the servo motor decelerates	Regenerative energy is too much	Reselect regenerative resistor capacity or review load and operation conditions.
□32	Power supply has open phase (When main power supply is ON, any of L1, L2 and L3 phases is under low voltage for over 1 s) * Detect when main circuit power is on	When control power supply is on	Servo drive circuit board develops fault	Replace the servo drive
		When main power supply is on	Three-phase electric wire has poor wiring	Correct wiring
			Three-phase electric wire is unbalanced	Correct unbalance of power supply (exchange of phase position)
			Servo drive circuit board develops fault	Replace the servo drive
		When the servo motor is actuated	Three-phase electric wire has poor wiring	Correct wiring
			Three-phase electric wire is unbalanced	Correct unbalance of power supply (exchange of phase position)
			Servo drive circuit board develops fault	Replace the servo drive
□33	Momentary outage alarm.	Normally during operation	There is outage of over one power cycle under AC current	Check supply circuit
□40	Bus encoder is	When control power	Wiring of encoder is wrong	Correct wiring of encoder

Alarm	Alarm contents	Circumstance	Cause	Treatment measures
	abnormal	supply is on	Encoder failure	Replace servo motor
			Servo drive circuit board develops fault	Replace the servo drive
		During operation	Wiring of encoder is wrong	Correct wiring of encoder
			Encoder cables are interfered due to different specifications	Change cable specifications to stranded wire or stranded shielded wire with core wire over 0.12 mm ² and stranded wire made of tined soft copper
			Encoder cables are interfered due to overlength	The max. wiring distance should be 20 m.
			Signal lines are interfered due to engaging-in and damage in sheath of encoder cables	Correct layout of encoder cables
			Encoder cables are bound with high current line or their distance is too close	Lay encoder cables at places free from surge voltage
			Change in FG potential due to influence by motor side equipment (welding machine, etc.)	Connect equipment ground wire to prevent shunting to FG at PG side
			Signal line of encoder is interfered	Take anti-interference measures for encoder wiring.
			Encoder failure	Replace servo motor
Servo drive circuit board develops fault	Replace the servo drive			
□41	Bus encoder overspeed	When control power supply is on	Servo motor rotates at a speed of over 100 r/min when PG power is on	PG power is set ON when servo rotating speed is less than 100 r/min
			Encoder failure	Replace servo motor
			Servo drive circuit board develops fault	Replace the servo drive
		During operation	Encoder failure	Replace servo motor
			Servo drive circuit board develops fault	Replace the servo drive
□42	Bus encoder FS status is wrong	Normally during operation	Encoder failure	Replace servo motor
			Servo drive circuit board develops fault	Replace the servo drive
□43	Bus encoder counter goes wrong	Normally during operation	Servo drive circuit board develops fault	Replace the servo drive
□44	Checkout in bus encoder control field is wrong	When control power supply is on or during operation	Encoder cables are interfered due to different specifications	Change cable specifications to stranded wire or stranded shielded wire with core wire over 12 mm ² and stranded wire made of tined soft copper
			Encoder cables are interfered due to overlength	The max. wiring distance should be 20 m.
			Signal lines are interfered due to engaging-in and damage in sheath of encoder cables	Correct layout of encoder cables
			Encoder cables are bound with high current	Lay encoder cables at places

Alarm	Alarm contents	Circumstance	Cause	Treatment measures
			line or their distance is too close	free from surge voltage
			Change in FG potential due to influence by motor side equipment (welding machine, etc.)	Connect equipment ground wire to prevent shunting to FG at PG side
			Signal line of encoder is interfered	Take anti-interference measures for encoder wiring.
□45	Bus encoder communication data checkout is wrong	When control power supply is on or during operation	Wiring of encoder is wrong	Correct wiring of encoder
			Encoder cables are interfered due to different specifications	Change cable specifications to stranded wire or stranded shielded wire with core wire over 12 mm ² and stranded wire made of tined soft copper
			Encoder cables are interfered due to overlength	The max. wiring distance should be 20 m.
			Signal lines are interfered due to engaging-in and damage in sheath of encoder cables	Correct layout of encoder cables
			Encoder cables are bound with high current line or their distance is too close	Lay encoder cables at places free from surge voltage
			Change in FG potential due to influence by motor side equipment (welding machine, etc.)	Connect equipment ground wire to prevent shunting to FG at PG side
			Signal line of encoder is interfered	Take anti-interference measures for encoder wiring.
			Encoder failure	Replace servo motor
			Servo drive circuit board develops fault	Replace the servo drive
□46	Cut-off position in bus encoder status field is wrong	When control power supply is on or during operation	Wiring of encoder is wrong	Correct wiring of encoder
			Encoder cables are interfered due to different specifications	Change cable specifications to stranded wire or stranded shielded wire with core wire over 12 mm ² and stranded wire made of tined soft copper
			Encoder cables are interfered due to overlength	The max. wiring distance should be 20 m.
			Signal lines are interfered due to engaging-in and damage in sheath of encoder cables	Correct layout of encoder cables
			Encoder cables are bound with high current line or their distance is too close	Lay encoder cables at places free from surge voltage
			Change in FG potential due to influence by motor side equipment (welding machine, etc.)	Connect equipment ground wire to prevent shunting to FG at PG side
			Signal line of encoder is interfered	Take anti-interference measures for encoder wiring.
			Encoder failure	Replace servo motor

Alarm	Alarm contents	Circumstance	Cause	Treatment measures
			Servo drive circuit board develops fault	Replace the servo drive
□47	When control power supply is on or during operation	When control power supply is on or during operation	Wiring of encoder is wrong	Correct wiring of encoder
			Encoder cables are interfered due to different specifications	Change cable specifications to stranded wire or stranded shielded wire with core wire over 12 mm ² and stranded wire made of tined soft copper
			Encoder cables are interfered due to overlength	The max. wiring distance should be 20 m.
			Signal lines are interfered due to engaging-in and damage in sheath of encoder cables	Correct layout of encoder cables
			Encoder cables are bound with high current line or their distance is too close	Lay encoder cables at places free from surge voltage
			Change in FG potential due to influence by motor side equipment (welding machine, etc.)	Connect equipment ground wire to prevent shunting to FG at PG side
			Signal line of encoder is interfered	Take anti-interference measures for encoder wiring.
			Encoder failure	Replace servo motor
			Servo drive circuit board develops fault	Replace the servo drive
□48	Bus encoder data is not initialized	When control power supply is on or during operation	Encoder EEROM is not initialized	Replace servo motor
□49	Sum check of bus encoder data is wrong	When control power supply is on or during operation	Wiring of encoder is wrong	Correct wiring of encoder
			Encoder cables are interfered due to different specifications	Change cable specifications to stranded wire or stranded shielded wire with core wire over 12 mm ² and stranded wire made of tined soft copper
			Encoder cables are interfered due to overlength	The max. wiring distance should be 20 m.
			Signal lines are interfered due to engaging-in and damage in sheath of encoder cables	Correct layout of encoder cables
			Encoder cables are bound with high current line or their distance is too close	Lay encoder cables at places free from surge voltage
			Change in FG potential due to influence by motor side equipment (welding machine, etc.)	Connect equipment ground wire to prevent shunting to FG at PG side
			Signal line of encoder is interfered	Take anti-interference measures for encoder wiring.
			Encoder failure	Replace servo motor
			Servo drive circuit board develops fault	Replace the servo drive
□70	Overheating	When control power	Servo drive circuit board develops fault	Replace the servo drive

Alarm	Alarm contents	Circumstance	Cause	Treatment measures
		supply is on	Overload alarm reset for several times due to power off	Change reset method of alarms
		Cooling fin is overheated when main power supply is ON or during motor operation	Load exceeds rated load.	Review loading condition, operation condition or motor capacity
			Ambient temperature of the servo drive exceeds 55 °C	Reduce ambient temperature of the servo drive to below 55 °C
			Servo drive circuit board develops fault	Replace the servo drive
□90	Software does not match with hardware	When control power supply is on	Servo drive circuit board develops fault	Replace the servo drive

7.1.3 Causes and Treatment Measures of Other Abnormalities

See the following table for causes and proper treatment measures of other abnormalities without alarm display. In case such abnormalities cannot be resolved after treatment, please contact agents or service technicians of the Company.

Abnormalities	Cause	Check method	Treatment measures
		Note: Checking and treatment should only be made after power supply of servo system is set to OFF.	
Servo motor fails to start	Control power supply is not connected	Check voltage between control power supply terminals	Correct control power supply ON circuit
	Main circuit power is not connected	Check voltage between main circuit power terminals	Correct main circuit power ON circuit
	Input/Output (CN3 connector) wiring is wrong or comes off	Check installation and wiring of CN3 connector	Correctly wire CN3 connector
	Wiring of servo motor and encoder comes off	Inspect wiring	Connect wiring
	Overload occurs	Conduct no-load trial operation	Reduce load or replace with servo motor with larger capacity
	Speed/position reference is not input	Check input pin	Correctly input speed/position reference
	Setting of input signal selection P□509 - P□512 is wrong	Check setting of input signal selection P□509 - P□512	Correctly set input signal selection P□509 - P□512
	Servo ON (/S-ON) input remains OFF	Confirm set value of user parameter P□50A.0	Correctly set user and set servo ON (/S-ON) input to ON
	SEN input remains OFF	Check SEN signal input (when using absolute encoder)	Set SEN signal input to ON
	Mode selection for reference pulse is wrong	Check use parameters setting and reference pulse shape	Correctly set user parameter P□200.1
	Speed reference input is improper during speed control	Confirm control method and input are consistent or check between V-REF and GND	Correctly set or input control parameter
Torque reference input is	Confirm control method and input	Correctly set or input control parameter	

Abnormalities	Cause	Check method	Treatment measures
		Note: Checking and treatment should only be made after power supply of servo system is set to OFF.	
	improper during torque control	are consistent or check between T-REF and GND	
	Position reference input is improper during position control	Check P□200.1 reference pulse signal shape or sign or sign+ pulse signal	Correctly set or input control parameter
	Shift pulse cleanout input (CLR) remains ON	Check CLR input	Set CLR input signal to OFF
	Positive rotation drive prohibited (P-OT) and negative rotation drive prohibited (N-OT) input signal remains OFF	Check POT or NOT input signal	Set POT or NOT input signal to ON
	Servo drive fault	Servo drive circuit board develops fault	Replace the servo drive
Servo motor stops after surge	Motor wiring is wrong	Check motor wiring	Correctly wire motor
	Encoder wiring is wrong	Check encoder wiring	Correctly wire encoder
Motor stops suddenly during operation and becomes motionless	Alarm reset (ALM-RST) signal remains ON and alarm goes off	Check alarm reset signal	Remove cause of alarm and set alarm reset signal from ON to OFF
Motor rotates unstably	Servo motor wiring is in bad contact	Power line (U, V and W phases) and encoder connector are in unstable connection	Tighten loose fastening part between treatment terminal and connector
Motor rotates when no reference has been sent	Speed reference input is improper during speed control	Confirm control method and input are consistent or check between V-REF and GND	Correctly set or input control parameter
	Torque reference input is improper during torque control	Confirm control method and input are consistent or check between T-REF and GND	Correctly set or input control parameter
	Speed reference offset	Offset adjustment of servo drive is poor	Adjust offset of servo drive
	Position reference input is improper during position control	Check P□200.1 reference pulse signal shape or sign or sign+ pulse signal	Correctly set or input control parameter
	Servo drive fault	Servo drive circuit board develops fault	Replace the servo drive
Motor sounds abnormally	Machines are improperly installed	Whether mounting screws of servo motor are loosed?	Tighten mounting screws
		Whether coupling core is aligned?	Align coupling core
		Whether coupling is unbalanced?	Restore coupling to balance
	Bearing is abnormal inside	Check sounds and vibration near	Please contact service technicians of the

Abnormalities	Cause	Check method	Treatment measures
		Note: Checking and treatment should only be made after power supply of servo system is set to OFF.	
		bearing	Company in case of any abnormality
	Supporting machines have vibration source	Whether any moving part at machine side has foreign objects or is damaged or deformed?	Please inquire relevant manufacturers
	Input signal lines are interfered due to different specifications	Whether stranded wire or stranded shielded wire has core wire over 0.12 mm ² and is made of tined soft copper?	Enable input signal line meet relevant specifications
	Input signal line is interfered due to length beyond range of application	Confirm that the max. wiring length is 3 m and its impedance is less than 100 Ω	Enable length of input signal line meet relevant specifications
	Encoder cables are interfered due to different specifications	Whether stranded wire or stranded shielded wire has core wire over 0.12 mm ² and is made of tined soft copper?	Enable encoder cables meet relevant specifications
	Encoder cables are interfered due to length beyond range of application	The max. wiring distance should be 20 m.	Enable encoder cables meet relevant specifications
	Encoder cables are interfered due to damages	Signal lines are interfered due to engaging-in and damage in sheath of encoder cables	Correct layout of encoder cables
	Interference to encoder cable is too great	Whether encoder cables are too close with high current line?	Lay encoder cables at places free from surge voltage
	Change in FG potential due to influence by servo motor side equipment (welding machine, etc.)	What is grounding state (not grounded or incomplete grounding) of welding machine, etc. at servo motor side?	Connect equipment ground wire to prevent shunting to FG at PG side
	Servo drive pulse counter goes wrong due to interference	Whether signal line of encoder is interfered?	Take anti-interference measures for encoder wiring.
	Encoder is affected by excessive vibration shock)	Mechanical vibration or motor installation is not in condition (Accuracy, fastening and core shift of mounting surface)	Reduce mechanical vibration or properly install servo motor
	Encoder failure	Encoder failure	Replace servo motor
Motor with frequency around 200 - 400 Hz vibrates	Speed gain P□100 is set too high	Factory setting: Kv = 40.0 Hz	Correctly set speed loop gain P□100
	Position loop gain P□102 is set too high	Factory setting: Kp = 40.0/s	Correctly set position loop gain P□102
	Speed loop integral time constant P□101 is improperly set	Factory setting: Ti = 20.00 ms	Correctly set speed loop integral time parameter P□101
	Machine stiffness is improperly set during autotune	Reassess selection of machine stiffness setting	Correctly select machine stiffness setting

Abnormalities	Cause	Check method	Treatment measures
		Note: Checking and treatment should only be made after power supply of servo system is set to OFF.	
	Ratio of moment of inertia is inappropriate when not using autotune	Check ratio of moment of inertia P□103	Correct ratio of moment of inertia P□103
Starting and stopping rotating overtravel is too large	Speed gain P□100 is set too high	Factory setting: $K_v = 40.0 \text{ Hz}$	Correctly set speed loop gain P□100
	Position loop gain P□102 is set too high	Factory setting: $K_p = 40.0/s$	Correctly set position loop gain P□102
	Speed loop integral time parameter P□101 is improperly set	Factory setting: $T_i = 20.00 \text{ ms}$	Correctly set speed loop integral time parameter P□101
	Machine stiffness is improperly set during autotune	Reassess selection of machine stiffness setting	Correctly select machine stiffness setting
	Ratio of moment of inertia is inappropriate when not using autotune	Check ratio of moment of inertia P□103	Correct ratio of moment of inertia P□103 Use module switch function
Position offset of absolute encoder is wrong (Position saved by command controller during outage is different from position when the power supply is on next time)	Encoder cables are interfered due to different specifications	stranded wire or stranded shielded wire has core wire over 0.12 mm^2 and is made of tinned soft copper	Enable encoder cables meet relevant specifications
	Encoder cables are interfered due to length beyond range of application	The max. wiring distance should be 20 m.	Enable encoder cables meet relevant specifications
	Encoder cables are interfered due to damages	Signal lines are interfered due to engaging-in and damage in sheath of encoder cables	Correct layout of encoder cables
	Interference to encoder cable is too great	Whether encoder cables are bound with high current line or their distance is too close?	Lay encoder cables at places free from surge voltage
	Fluctuation of FG potential due to interference by motor side equipment (welding machine, etc.)	What is grounding state (not grounded or incomplete grounding) of welding machine, etc. at servo motor side?	Connect equipment ground wire to prevent shunting to FG at PG side
	Servo drive pulse counter goes wrong due to interference	Whether signal line of encoder is interfered?	Take anti-interference measures for encoder wiring.
	Encoder is affected by excessive vibration shock	Mechanical vibration or motor installation is not in condition (Accuracy, fastening and core shift of mounting surface)	Reduce mechanical vibration or properly install servo motor
	Encoder failure	Encoder failure (no change in pulse)	Replace servo motor
	Servo drive fault	Servo drive fails to send multi-turn data	Replace the servo drive
Command controller multi-turn	Check error detection of command	Restore error detection function of	

Abnormalities	Cause	Check method	Treatment measures
		Note: Checking and treatment should only be made after power supply of servo system is set to OFF.	
	data read error	controller	command controller
		Whether data (odd-even) check is executed on command controller?	Execute odd-even check of multi-turn data
		Signal line between servo drive and command controller is interfered	Interference effect occurs when no checkout is done (above)
Overtravel (OT) (Exceeding scope specified by command controller)	Positive/negative rotation drive prohibited input signal reaches (POT or NOT is at H level)	Whether external power supply (+24 V) of input signal is correct?	Correct external power supply of +24 V
		Whether action state of overtravel limit SW is correct?	Correct state of overtravel limit SW
		Whether wiring of overtravel limit SW is correct?	Correct wiring of overtravel limit SW
	Positive/negative rotation drive prohibited input signal is malfunctioning (POT or NOT changes constantly)	Whether external power supply (+24 V) of input signal changes?	Remove cause of change in external power supply of +24 V
		Whether action of overtravel limit SW is unstable?	Make action of overtravel limit SW unstable
		Whether wiring of overtravel limit SW is correct? (Cable damage and screw fastening)	Correct wiring of overtravel limit SW
	Positive/negative rotation drive prohibited input signal P-OT/N-OT signal selection is wrong	Check POT signal selection P□510.2	Correct POT signal selection P□510.2
		Check NOT signal selection P□510.3	Correct NOT signal selection P□510.3
	Motor stop method selection is wrong	What is the selection for inertial operation stop when servo is OFF?	Check P□000.2 and P□000.3
		What is the setting for inertial operation during torque control?	Check P□000.2 and P□000.3
	Overtravel position is not proper	OT position is shorter than operation distance	Properly set Ot position
	Encoder cables are interfered due to different specifications	Whether stranded wire or stranded shielded wire has core wire over 0.12 mm ² and is made of tined soft copper?	Enable encoder cables meet relevant specifications
	Encoder cables are interfered due to length beyond range of application	The max. wiring distance should be 20 m.	Enable encoder cables meet relevant specifications
Encoder cables are interfered due to damages	Signal lines are interfered due to engaging-in and damage in sheath of encoder cables	Correct layout of encoder cables	
Interference to encoder cable is too great	Whether encoder cables are bound with high current line or their	Lay encoder cables at places free from surge voltage	

Abnormalities	Cause	Check method	Treatment measures
		Note: Checking and treatment should only be made after power supply of servo system is set to OFF.	
		distance is too close?	
	Change in FG potential due to influence by servo motor side equipment (welding machine, etc.)	What is grounding state (not grounded or incomplete grounding) of welding machine, etc. at servo motor side?	Connect equipment ground wire to prevent shunting to FG at PG side
	Servo unit pulse counter goes wrong due to interference	Whether signal line of encoder is interfered?	Take anti-interference measures for encoder wiring.
	Encoder is affected by excessive vibration shock	Mechanical vibration or motor installation is not in condition (accuracy, fastening and core shift of mounting surface)	Reduce mechanical vibration or properly install servo motor
	Encoder failure	Encoder failure (no change in pulse)	Replace servo motor
	Servo drive fault	Servo drive fails to send multi-turn data	Replace the servo drive
Position offset (alarm fails and causes position offset)	Coupling between machine and servo motor is abnormal	Whether coupling between machine and servo motor has offset?	Correctly connect coupling between machine and servo motor
	Input signal lines are interfered due to different specifications	Whether stranded wire or stranded shielded wire has core wire over 0.12 mm ² and is made of tinned soft copper?	Enable input signal line meet relevant specifications
	Input signal line is interfered due to length beyond range of application	Confirm that the max. wiring length is 3 m and its impedance is less than 100 Ω	Enable length of input signal line meet relevant specifications
	Encoder failure (no change in pulse)	Encoder failure (no change in pulse)	Replace servo motor

7.2 Maintenance and Check of Servo Drive

7.2.1 Check of Servo Motor

Since AC servo motor is not equipped with electric brush, only simple daily check is required. The table lists general standards of checking period which should be properly determined based on actual using conditions and environment.

Check item	Check period	Tips for check and maintenance	Remarks
Confirmation of vibration and sound	Everyday	Determine based on feeling and hearing	Compare with normal condition to detect any increase
Appearance	Based on contamination	Clean up with brush or air	—

inspection		gun	
Measurement of insulation resistance	Once every year	Disconnect from servo unit and measure insulation resistance with 500 V megameter. Resistance over 10 MΩ is considered as normal.	Please contact local dealer in case the resistance is less than 10 MΩ.
Replacement of oil seal	Once at least every 5000 h	Please contact local dealer.	Only for servo motor with oil seal
Comprehensive check	Once every five years or at least every 20000 h	Please contact local dealer.	—

7.2.2 Check of Servo Drive

Daily check is not required, but more than one check is needed every year.

Check item	Check period	Tips for check and maintenance	Remarks
Cleaning of main body and circuit board	Once every year	Please contact local dealer.	
Loosening of screws		Mounting screws of terminal board and connector should be firmly secured without loosening.	Please further secure screws.

7.2.3 General Standards of Replacement of Internal Parts of Servo Drive

Mechanical abrasion and aging will occur to electric and electronic parts. Therefore, regular check is required for safety purpose. In need of replacement of parts, local dealer should be contacted. Use parameters of servo drives overhauled by the Company will be restored to factory setting and user parameters for using should be set before operation.

Part Name	Years of revision of standards	Use conditions
Cooling fan	4-5 years	Ambient temperature: annual average of 30 °C Load rate: below 80% Operating ratio: less than 20 h every day
Smoothing capacitor	7 - 8 years	
Relays	—	
Fuse	10 years	
Aluminium electrolytic capacitor on PCB	5 years	

Appendix A Summary of User Parameters

Parameter No.	Name	Setting range	Setting unit	Factory setting	Power reboot	Remarks																																								
P□000	Basic function selection switch	—	—	0010	Y																																									
	<p>Rotation direction selection</p> <table border="1"> <tr> <td>0</td> <td>CCW (counter clockwise) is the positive rotation direction</td> </tr> <tr> <td>1</td> <td>CW (clockwise) is the positive rotation direction (in reserve mode)</td> </tr> </table> <p>Control mode selection</p> <table border="1"> <tr> <td>0</td> <td>Speed control (analog reference)</td> </tr> <tr> <td>1</td> <td>Position control (pulse train reference)</td> </tr> <tr> <td>2</td> <td>Torque control (analog reference)</td> </tr> <tr> <td>3</td> <td>Internal set speed control (contact reference)</td> </tr> <tr> <td>4</td> <td>Internal set speed control (contact reference) ↔ Speed control (analog reference)</td> </tr> <tr> <td>5</td> <td>Internal set speed control (contact reference) ↔ Position control (pulse train reference)</td> </tr> <tr> <td>6</td> <td>Internal set speed control (contact reference) ↔ Torque control (analog reference)</td> </tr> <tr> <td>7</td> <td>Position control (pulse train reference) ↔ Speed control (analog reference)</td> </tr> <tr> <td>8</td> <td>Position control (pulse train reference) ↔ Speed control (analog reference)</td> </tr> <tr> <td>9</td> <td>Torque control (analog reference) ↔ Speed control (analog reference)</td> </tr> <tr> <td>A</td> <td>Speed control (analog reference) ↔ Zero clamping</td> </tr> <tr> <td>B</td> <td>Position control (pulse train reference) ↔ Position control (pulse prohibited)</td> </tr> <tr> <td>C</td> <td>Internal position control</td> </tr> </table> <p>Stop method when servo is OFF</p> <table border="1"> <tr> <td>0</td> <td>Reverse braking the motor decelerates to a stop, then Set it to free-running status</td> </tr> <tr> <td>1</td> <td>Set motor to inertial operation state</td> </tr> </table> <p>Stop method during overtravel (OT)</p> <table border="1"> <tr> <td>0</td> <td>Reverse braking the motor decelerates to a stop, then Set it to free-running status</td> </tr> <tr> <td>1</td> <td>Reverse braking the motor decelerates to a stop, then Set it to free-running status</td> </tr> <tr> <td>2</td> <td>Set motor to inertial operation state</td> </tr> </table>						0	CCW (counter clockwise) is the positive rotation direction	1	CW (clockwise) is the positive rotation direction (in reserve mode)	0	Speed control (analog reference)	1	Position control (pulse train reference)	2	Torque control (analog reference)	3	Internal set speed control (contact reference)	4	Internal set speed control (contact reference) ↔ Speed control (analog reference)	5	Internal set speed control (contact reference) ↔ Position control (pulse train reference)	6	Internal set speed control (contact reference) ↔ Torque control (analog reference)	7	Position control (pulse train reference) ↔ Speed control (analog reference)	8	Position control (pulse train reference) ↔ Speed control (analog reference)	9	Torque control (analog reference) ↔ Speed control (analog reference)	A	Speed control (analog reference) ↔ Zero clamping	B	Position control (pulse train reference) ↔ Position control (pulse prohibited)	C	Internal position control	0	Reverse braking the motor decelerates to a stop, then Set it to free-running status	1	Set motor to inertial operation state	0	Reverse braking the motor decelerates to a stop, then Set it to free-running status	1	Reverse braking the motor decelerates to a stop, then Set it to free-running status	2	Set motor to inertial operation state
0	CCW (counter clockwise) is the positive rotation direction																																													
1	CW (clockwise) is the positive rotation direction (in reserve mode)																																													
0	Speed control (analog reference)																																													
1	Position control (pulse train reference)																																													
2	Torque control (analog reference)																																													
3	Internal set speed control (contact reference)																																													
4	Internal set speed control (contact reference) ↔ Speed control (analog reference)																																													
5	Internal set speed control (contact reference) ↔ Position control (pulse train reference)																																													
6	Internal set speed control (contact reference) ↔ Torque control (analog reference)																																													
7	Position control (pulse train reference) ↔ Speed control (analog reference)																																													
8	Position control (pulse train reference) ↔ Speed control (analog reference)																																													
9	Torque control (analog reference) ↔ Speed control (analog reference)																																													
A	Speed control (analog reference) ↔ Zero clamping																																													
B	Position control (pulse train reference) ↔ Position control (pulse prohibited)																																													
C	Internal position control																																													
0	Reverse braking the motor decelerates to a stop, then Set it to free-running status																																													
1	Set motor to inertial operation state																																													
0	Reverse braking the motor decelerates to a stop, then Set it to free-running status																																													
1	Reverse braking the motor decelerates to a stop, then Set it to free-running status																																													
2	Set motor to inertial operation state																																													
P□001	Basic function selection switch 1	—	—	0001	Y																																									

Parameter No.	Name	Setting range	Setting unit	Factory setting	Power reboot	Remarks																							
	<div style="display: flex; align-items: center;"> <div style="margin-right: 10px;"> H </div> <div style="display: flex; gap: 10px;"> <div style="text-align: center;">Bit 3 <input type="checkbox"/></div> <div style="text-align: center;">Bit 2 <input type="checkbox"/></div> <div style="text-align: center;">Bit 1 <input type="checkbox"/></div> <div style="text-align: center;">Bit 0 <input type="checkbox"/></div> </div> </div> <div style="border: 1px solid black; padding: 5px;"> <p>Use method of encoder</p> <table border="1" style="width: 100%; border-collapse: collapse;"> <tr><td style="width: 30px; text-align: center;">0</td><td>Use absolute encoder as absolute encoder and enable serial output of absolute data (PG frequency dividing PAO□)</td></tr> <tr><td style="text-align: center;">1</td><td>Use absolute encoder as incremental encoder</td></tr> <tr><td style="text-align: center;">2</td><td>Use absolute encoder as absolute encoder and disable serial output of absolute data</td></tr> </table> </div> <div style="border: 1px solid black; padding: 5px;"> <p>Speed control option (T-REF distribution)</p> <table border="1" style="width: 100%; border-collapse: collapse;"> <tr><td style="width: 30px; text-align: center;">0</td><td>N A</td></tr> <tr><td style="text-align: center;">1</td><td>Use T-REF as external torque limit input</td></tr> <tr><td style="text-align: center;">2</td><td>Use T-REF as torque feedforward input</td></tr> <tr><td style="text-align: center;">3</td><td>Use T-REF as external torque limit input when P-CL and N-CL are enabled</td></tr> </table> </div> <div style="border: 1px solid black; padding: 5px;"> <p>Torque control option (V-REF distribution)</p> <table border="1" style="width: 100%; border-collapse: collapse;"> <tr><td style="width: 30px; text-align: center;">0</td><td>N A</td></tr> <tr><td style="text-align: center;">1</td><td>Use V-REF as external torque limit input</td></tr> </table> </div> <div style="border: 1px solid black; padding: 5px;"> <p>Accelerated speed feedforward mode selection</p> <table border="1" style="width: 100%; border-collapse: collapse;"> <tr><td style="width: 30px; text-align: center;">0</td><td>Accelerated speed feedforward type 1 (filtering calculation)</td></tr> <tr><td style="text-align: center;">1</td><td>Accelerated speed feedforward type 2 (rapid calculation)</td></tr> </table> </div>	0	Use absolute encoder as absolute encoder and enable serial output of absolute data (PG frequency dividing PAO□)	1	Use absolute encoder as incremental encoder	2	Use absolute encoder as absolute encoder and disable serial output of absolute data	0	N A	1	Use T-REF as external torque limit input	2	Use T-REF as torque feedforward input	3	Use T-REF as external torque limit input when P-CL and N-CL are enabled	0	N A	1	Use V-REF as external torque limit input	0	Accelerated speed feedforward type 1 (filtering calculation)	1	Accelerated speed feedforward type 2 (rapid calculation)						
0	Use absolute encoder as absolute encoder and enable serial output of absolute data (PG frequency dividing PAO□)																												
1	Use absolute encoder as incremental encoder																												
2	Use absolute encoder as absolute encoder and disable serial output of absolute data																												
0	N A																												
1	Use T-REF as external torque limit input																												
2	Use T-REF as torque feedforward input																												
3	Use T-REF as external torque limit input when P-CL and N-CL are enabled																												
0	N A																												
1	Use V-REF as external torque limit input																												
0	Accelerated speed feedforward type 1 (filtering calculation)																												
1	Accelerated speed feedforward type 2 (rapid calculation)																												
P□002	Basic function selection switch 2	—	—	1100	Y																								
	<div style="display: flex; align-items: center;"> <div style="margin-right: 10px;"> H </div> <div style="display: flex; gap: 10px;"> <div style="text-align: center;">Bit 3 <input type="checkbox"/></div> <div style="text-align: center;">Bit 2 <input type="checkbox"/></div> <div style="text-align: center;">Bit 1 <input type="checkbox"/></div> <div style="text-align: center;">Bit 0 <input type="checkbox"/></div> </div> </div> <div style="border: 1px solid black; padding: 5px;"> <p>Second electronic gear enabled</p> <table border="1" style="width: 100%; border-collapse: collapse;"> <tr><td style="width: 30px; text-align: center;">0</td><td>Disable second electronic gear and use /P-CON signal as P/PI switch</td></tr> <tr><td style="text-align: center;">1</td><td>Enable second electronic gear and use /P-CON signal as second electronic gear switch</td></tr> </table> </div> <div style="border: 1px solid black; padding: 5px;"> <p>Preset constant (do not change)</p> <table border="1" style="width: 100%; border-collapse: collapse;"> <tr><td style="width: 30px; text-align: center;">0</td><td>Reserved</td></tr> <tr><td style="text-align: center;">1</td><td>Reserved</td></tr> </table> </div> <div style="border: 1px solid black; padding: 5px;"> <p>Preset constant (do not change)</p> <table border="1" style="width: 100%; border-collapse: collapse;"> <tr><td style="width: 30px; text-align: center;">0</td><td>Reserved</td></tr> <tr><td style="text-align: center;">1</td><td>Reserved</td></tr> </table> </div> <div style="border: 1px solid black; padding: 5px;"> <p>Preset constant (do not change)</p> <table border="1" style="width: 100%; border-collapse: collapse;"> <tr><td style="width: 30px; text-align: center;">0</td><td>Reserved</td></tr> <tr><td style="text-align: center;">1</td><td>Reserved</td></tr> </table> </div>	0	Disable second electronic gear and use /P-CON signal as P/PI switch	1	Enable second electronic gear and use /P-CON signal as second electronic gear switch	0	Reserved	1	Reserved	0	Reserved	1	Reserved	0	Reserved	1	Reserved												
0	Disable second electronic gear and use /P-CON signal as P/PI switch																												
1	Enable second electronic gear and use /P-CON signal as second electronic gear switch																												
0	Reserved																												
1	Reserved																												
0	Reserved																												
1	Reserved																												
0	Reserved																												
1	Reserved																												
P□003	Basic function selection switch 3	—	—	0000	Y																								

Parameter No.	Name	Setting range	Setting unit	Factory setting	Power reboot	Remarks																
	<p>Common encoder (non-serial encoder) alarm enable switch</p> <table border="1"> <tr><td>0</td><td>Disable A05 - A08 or b05 - b08 alarm detection</td></tr> <tr><td>1</td><td>Enable A05 - A08 or b05 - b08 alarm detection</td></tr> </table> <p>Preset constant (do not change)</p> <table border="1"> <tr><td>0</td><td>Reserved</td></tr> <tr><td>1</td><td>Reserved</td></tr> </table> <p>Momentary outage alarm enable switch</p> <table border="1"> <tr><td>0</td><td>No alarm for momentary outage of one cycle</td></tr> <tr><td>1</td><td>Alarm for momentary outage of one cycle</td></tr> </table> <p>Overload enhancement enable switch</p> <table border="1"> <tr><td>0</td><td>Disable overload enhancement function</td></tr> <tr><td>1</td><td>Enable overload enhancement function (enhance overload capacity, suitable for occasion with frequent start and stop)</td></tr> </table>	0	Disable A05 - A08 or b05 - b08 alarm detection	1	Enable A05 - A08 or b05 - b08 alarm detection	0	Reserved	1	Reserved	0	No alarm for momentary outage of one cycle	1	Alarm for momentary outage of one cycle	0	Disable overload enhancement function	1	Enable overload enhancement function (enhance overload capacity, suitable for occasion with frequent start and stop)					
0	Disable A05 - A08 or b05 - b08 alarm detection																					
1	Enable A05 - A08 or b05 - b08 alarm detection																					
0	Reserved																					
1	Reserved																					
0	No alarm for momentary outage of one cycle																					
1	Alarm for momentary outage of one cycle																					
0	Disable overload enhancement function																					
1	Enable overload enhancement function (enhance overload capacity, suitable for occasion with frequent start and stop)																					
P□004	Basic function selection switch 4	—	—	0100	Y																	
	<p>Preset constant (do not change)</p> <table border="1"> <tr><td>0</td><td>Reserved</td></tr> <tr><td>1</td><td>Reserved</td></tr> </table> <p>Preset constant (do not change)</p> <table border="1"> <tr><td>0</td><td>Reserved</td></tr> </table> <p>Low-frequency jitter suppression enable switch</p> <table border="1"> <tr><td>0</td><td>Disable low-frequency jitter suppression</td></tr> <tr><td>1</td><td>Enable low-frequency jitter suppression</td></tr> </table> <p>Out-of-tolerance alarm enable switch</p> <table border="1"> <tr><td>0</td><td>Disable out-of-tolerance alarm detection</td></tr> <tr><td>1</td><td>Enable out-of-tolerance alarm detection (alarm will be given when offset counter value exceeds P□504)</td></tr> </table>	0	Reserved	1	Reserved	0	Reserved	0	Disable low-frequency jitter suppression	1	Enable low-frequency jitter suppression	0	Disable out-of-tolerance alarm detection	1	Enable out-of-tolerance alarm detection (alarm will be given when offset counter value exceeds P□504)							
0	Reserved																					
1	Reserved																					
0	Reserved																					
0	Disable low-frequency jitter suppression																					
1	Enable low-frequency jitter suppression																					
0	Disable out-of-tolerance alarm detection																					
1	Enable out-of-tolerance alarm detection (alarm will be given when offset counter value exceeds P□504)																					
P□100	Speed loop gain	1 ~ 2500	0.1 Hz	400	N																	
P□101	Speed loop integral time constant	1 ~ 4000	0.01ms	2000	N																	
P□102	Position loop gain	1 ~ 2000	0.1/s	400	N																	
P□103	Moment of inertia ratio	0 ~ 20000	1 %	0	N																	
P□104	Second speed loop gain	1 ~ 2500	0.1 Hz	400	N																	
P□105	Second speed loop integral time constant	1 ~ 4000	0.01ms	2000	N																	
P□106	Second position loop gain	1 ~ 2000	0.1/s	400	N																	
P□107	Offset (speed offset)	0 ~ 450	1r/min	0	N																	
P□108	Scope of offset stack	0 ~ 5000	1-reference pulse	10	N																	
P□109	Feedforward gain	0 ~ 100	1 %	0	N																	
P□110	Feedforward filter time constant	0 ~ 640	0.1ms	0	N																	
P□111	Accelerated speed freeforward percentage	0 ~ 100	1 %	0	N																	

Parameter No.	Name	Setting range	Setting unit	Factory setting	Power reboot	Remarks																											
P□112	Accelerated speed feedforward filter time constant	0 ~ 640	0.1ms	0	N																												
P□113	Application function for gain select switch	0000 ~ 0064	—	0000	Y																												
	<table border="1" style="margin-left: 20px;"> <thead> <tr> <th colspan="2">Module switch selection</th> </tr> </thead> <tbody> <tr> <td>0</td> <td>Use internal torque reference as the condition (level setting: P□114)</td> </tr> <tr> <td>1</td> <td>Use speed as the condition (level setting: P□115)</td> </tr> <tr> <td>2</td> <td>Use acceleration as the condition (level setting: P□116)</td> </tr> <tr> <td>3</td> <td>Use position error pulse as the condition (level setting: P□117)</td> </tr> <tr> <td>4</td> <td>No mode switch function</td> </tr> </tbody> </table> <table border="1" style="margin-left: 20px;"> <thead> <tr> <th colspan="2">Selection of auto gain switch conditions</th> </tr> </thead> <tbody> <tr> <td>0</td> <td>Non-auto gain switch (fixed to first group gain)</td> </tr> <tr> <td>1</td> <td>External switch gain switch (G-SEL signal)</td> </tr> <tr> <td>2</td> <td>Torque percentage switch</td> </tr> <tr> <td>3</td> <td>Switch only under position offset</td> </tr> <tr> <td>4</td> <td>Given accelerated speed value (10 r/min/s)</td> </tr> <tr> <td>5</td> <td>Given speed value</td> </tr> <tr> <td>6</td> <td>With position reference input</td> </tr> </tbody> </table> <p style="margin-left: 20px;">Reserved</p> <p style="margin-left: 20px;">Reserved</p>						Module switch selection		0	Use internal torque reference as the condition (level setting: P□114)	1	Use speed as the condition (level setting: P□115)	2	Use acceleration as the condition (level setting: P□116)	3	Use position error pulse as the condition (level setting: P□117)	4	No mode switch function	Selection of auto gain switch conditions		0	Non-auto gain switch (fixed to first group gain)	1	External switch gain switch (G-SEL signal)	2	Torque percentage switch	3	Switch only under position offset	4	Given accelerated speed value (10 r/min/s)	5	Given speed value	6
Module switch selection																																	
0	Use internal torque reference as the condition (level setting: P□114)																																
1	Use speed as the condition (level setting: P□115)																																
2	Use acceleration as the condition (level setting: P□116)																																
3	Use position error pulse as the condition (level setting: P□117)																																
4	No mode switch function																																
Selection of auto gain switch conditions																																	
0	Non-auto gain switch (fixed to first group gain)																																
1	External switch gain switch (G-SEL signal)																																
2	Torque percentage switch																																
3	Switch only under position offset																																
4	Given accelerated speed value (10 r/min/s)																																
5	Given speed value																																
6	With position reference input																																
P□114	Mode switch (torque reference)	0 ~ 300	1 %	200	N																												
P□115	Mode switch (speed reference)	0 ~ 10000	1r/min	0	N																												
P□116	Mode switch (accelerated speed reference)	0 ~ 3000	10 r/min/s	0	N																												
P□117	Mode switch (offset pulse)	0 ~ 10000	1-reference pulse	0	N																												
P□118	Gain switch delay time	0 ~ 20000	0.1 ms (single axis)	0	N	0.2 ms (double axis)																											
P□119	Gain switch range	0 ~ 20000	free	0	N																												
When P□113.1 = 2, the unit is 1% When P□113.1 = 3, the unit is 1 reference pulse When P□113.1 = 4, the unit is 10 r/min/s When P□113.1 = 5, the unit is 1 r/min When P□113.1 = 6, the unit is 1 reference pulse																																	
P□120	Position gain switch time	0 ~ 20000	0.1 ms (single axis)	0	N	0.2 ms (double axis)																											
P□121	Gain switch hysteresis	0 ~ 20000	1-reference pulse	0	N																												
P□122	Friction load	0 ~ 3000	1‰	0	N																												
P□123	Friction compensation speed hysteresis area	0 ~ 100	1r/min	0	Y																												
P□124	Viscous friction load	0 ~ 20000	1 ‰/1 krpm	0	N																												
P□125	Friction gain	0 ~ 30000		0	N																												

Parameter No.	Name	Setting range	Setting unit	Factory setting	Power reboot	Remarks																																																			
P□126	Speed observer period	0 ~ 100	0.1ms	0/35/70	N																																																				
P□127	Online autotune switches	—	—	1340	Y/N																																																				
<div style="display: flex; align-items: flex-start;"> <div style="margin-right: 20px;"> <p>H</p> <div style="display: flex; justify-content: space-around; width: 100px;"> <div style="text-align: center;">Bit 3 <input type="checkbox"/></div> <div style="text-align: center;">Bit 2 <input type="checkbox"/></div> <div style="text-align: center;">Bit 1 <input type="checkbox"/></div> <div style="text-align: center;">Bit 0 <input type="checkbox"/></div> </div> </div> <table border="1" style="width: 100%; border-collapse: collapse;"> <thead> <tr style="background-color: black; color: white;"> <th colspan="2">Real-time auto gain setting</th> <th>Power reboot</th> </tr> </thead> <tbody> <tr> <td style="text-align: center;">0</td> <td>Non-real-time auto gain adjustment</td> <td rowspan="7" style="text-align: center; vertical-align: middle;">Y</td> </tr> <tr> <td style="text-align: center;">1</td> <td>Normal mode (suitable for operations without change in load inertia)</td> </tr> <tr> <td style="text-align: center;">2</td> <td>Normal mode (suitable for operations with little change in load inertia)</td> </tr> <tr> <td style="text-align: center;">3</td> <td>Normal mode (suitable for operations with great change in load inertia)</td> </tr> <tr> <td style="text-align: center;">4</td> <td>Vertical load (suitable for operations without change in load inertia)</td> </tr> <tr> <td style="text-align: center;">5</td> <td>Vertical load (suitable for operations with little change in load inertia)</td> </tr> <tr> <td style="text-align: center;">6</td> <td>Vertical load (suitable for operations with great change in load inertia)</td> </tr> <tr style="background-color: black; color: white;"> <th colspan="2">Selection of machine stiffness for real-time auto gain</th> <th>Power reboot</th> </tr> <tr> <td style="text-align: center;">0</td> <td>Machine stiffness during real-time auto gain adjustment may be selected. The larger the parameter value is, the quicker the response will be.</td> <td rowspan="3" style="text-align: center; vertical-align: middle;">N</td> </tr> <tr> <td style="text-align: center;">...</td> <td>If this parameter is set very high all at once, system gain will change significantly, leading to great shock to machine.</td> </tr> <tr> <td style="text-align: center;">F</td> <td>It is recommended to set a small value and gradually select larger stiffness while monitoring operating status of machine.</td> </tr> <tr style="background-color: black; color: white;"> <th colspan="3">Reserved</th> </tr> <tr style="background-color: black; color: white;"> <th colspan="2">Normal auto adjustment mode setting</th> <th>Power reboot</th> </tr> <tr> <td style="text-align: center;">0</td> <td>Rotating circles: 1; direction: CCW → CW</td> <td rowspan="8" style="text-align: center; vertical-align: middle;">N</td> </tr> <tr> <td style="text-align: center;">1</td> <td>Rotating circles: 2; direction: CCW → CW</td> </tr> <tr> <td style="text-align: center;">2</td> <td>Rotating circles: 3; direction: CCW → CW</td> </tr> <tr> <td style="text-align: center;">3</td> <td>Rotating circles: 4; direction: CCW → CW</td> </tr> <tr> <td style="text-align: center;">4</td> <td>Rotating circles: 1; direction: CW → CCW</td> </tr> <tr> <td style="text-align: center;">5</td> <td>Rotating circles: 2; direction: CW → CCW</td> </tr> <tr> <td style="text-align: center;">6</td> <td>Rotating circles: 3; direction: CW → CCW</td> </tr> <tr> <td style="text-align: center;">7</td> <td>Rotating circles: 4; direction: CW → CCW</td> </tr> </tbody> </table> </div>							Real-time auto gain setting		Power reboot	0	Non-real-time auto gain adjustment	Y	1	Normal mode (suitable for operations without change in load inertia)	2	Normal mode (suitable for operations with little change in load inertia)	3	Normal mode (suitable for operations with great change in load inertia)	4	Vertical load (suitable for operations without change in load inertia)	5	Vertical load (suitable for operations with little change in load inertia)	6	Vertical load (suitable for operations with great change in load inertia)	Selection of machine stiffness for real-time auto gain		Power reboot	0	Machine stiffness during real-time auto gain adjustment may be selected. The larger the parameter value is, the quicker the response will be.	N	...	If this parameter is set very high all at once, system gain will change significantly, leading to great shock to machine.	F	It is recommended to set a small value and gradually select larger stiffness while monitoring operating status of machine.	Reserved			Normal auto adjustment mode setting		Power reboot	0	Rotating circles: 1; direction: CCW → CW	N	1	Rotating circles: 2; direction: CCW → CW	2	Rotating circles: 3; direction: CCW → CW	3	Rotating circles: 4; direction: CCW → CW	4	Rotating circles: 1; direction: CW → CCW	5	Rotating circles: 2; direction: CW → CCW	6	Rotating circles: 3; direction: CW → CCW	7	Rotating circles: 4; direction: CW → CCW
Real-time auto gain setting		Power reboot																																																							
0	Non-real-time auto gain adjustment	Y																																																							
1	Normal mode (suitable for operations without change in load inertia)																																																								
2	Normal mode (suitable for operations with little change in load inertia)																																																								
3	Normal mode (suitable for operations with great change in load inertia)																																																								
4	Vertical load (suitable for operations without change in load inertia)																																																								
5	Vertical load (suitable for operations with little change in load inertia)																																																								
6	Vertical load (suitable for operations with great change in load inertia)																																																								
Selection of machine stiffness for real-time auto gain		Power reboot																																																							
0	Machine stiffness during real-time auto gain adjustment may be selected. The larger the parameter value is, the quicker the response will be.	N																																																							
...	If this parameter is set very high all at once, system gain will change significantly, leading to great shock to machine.																																																								
F	It is recommended to set a small value and gradually select larger stiffness while monitoring operating status of machine.																																																								
Reserved																																																									
Normal auto adjustment mode setting		Power reboot																																																							
0	Rotating circles: 1; direction: CCW → CW	N																																																							
1	Rotating circles: 2; direction: CCW → CW																																																								
2	Rotating circles: 3; direction: CCW → CW																																																								
3	Rotating circles: 4; direction: CCW → CW																																																								
4	Rotating circles: 1; direction: CW → CCW																																																								
5	Rotating circles: 2; direction: CW → CCW																																																								
6	Rotating circles: 3; direction: CW → CCW																																																								
7	Rotating circles: 4; direction: CW → CCW																																																								
P□200	Position control reference form selection switch	—	—	0000	Y																																																				

Parameter No.	Name	Setting range	Setting unit	Factory setting	Power reboot	Remarks																																					
	<p>H <input type="checkbox"/> Bit 3 <input type="checkbox"/> Bit 2 <input type="checkbox"/> Bit 1 <input type="checkbox"/> Bit 0</p> <table border="1"> <thead> <tr> <th colspan="2">Offset pulse clearing method</th> </tr> </thead> <tbody> <tr> <td>0</td> <td>Clear error pulse(servo OFF); Does not clear error pulse(over travel)</td> </tr> <tr> <td>1</td> <td>Does not clear offset pulse(servo OFF or over travel)</td> </tr> <tr> <td>2</td> <td>Clear offset pulse (servo OFF or over travel ,except for zero clamping position)</td> </tr> </tbody> </table> <table border="1"> <thead> <tr> <th colspan="2">Reference pulse form</th> </tr> </thead> <tbody> <tr> <td>0</td> <td>Sign + pulse</td> </tr> <tr> <td>1</td> <td>CW+CCW</td> </tr> <tr> <td>2</td> <td>A phase + B phase (1x frequency)</td> </tr> <tr> <td>3</td> <td>A phase + B phase (2x frequency)</td> </tr> <tr> <td>4</td> <td>A phase + B phase (4x frequency)</td> </tr> </tbody> </table> <table border="1"> <thead> <tr> <th colspan="2">Reverse setting of reference pulse signal</th> </tr> </thead> <tbody> <tr> <td>0</td> <td>Does not reverse PULS and SIGN</td> </tr> <tr> <td>1</td> <td>Does not reverse PULS, reverse SIGN</td> </tr> <tr> <td>2</td> <td>Reverse PULS , does not reverse SIGN</td> </tr> <tr> <td>3</td> <td>Reverse PULS and SIGN</td> </tr> </tbody> </table> <table border="1"> <thead> <tr> <th colspan="2">Filter selection</th> </tr> </thead> <tbody> <tr> <td>0</td> <td>Bus driver signal reference input filter</td> </tr> <tr> <td>1</td> <td>Collector open-circuit signal reference input filter</td> </tr> </tbody> </table>	Offset pulse clearing method		0	Clear error pulse(servo OFF); Does not clear error pulse(over travel)	1	Does not clear offset pulse(servo OFF or over travel)	2	Clear offset pulse (servo OFF or over travel ,except for zero clamping position)	Reference pulse form		0	Sign + pulse	1	CW+CCW	2	A phase + B phase (1x frequency)	3	A phase + B phase (2x frequency)	4	A phase + B phase (4x frequency)	Reverse setting of reference pulse signal		0	Does not reverse PULS and SIGN	1	Does not reverse PULS, reverse SIGN	2	Reverse PULS , does not reverse SIGN	3	Reverse PULS and SIGN	Filter selection		0	Bus driver signal reference input filter	1	Collector open-circuit signal reference input filter						
Offset pulse clearing method																																											
0	Clear error pulse(servo OFF); Does not clear error pulse(over travel)																																										
1	Does not clear offset pulse(servo OFF or over travel)																																										
2	Clear offset pulse (servo OFF or over travel ,except for zero clamping position)																																										
Reference pulse form																																											
0	Sign + pulse																																										
1	CW+CCW																																										
2	A phase + B phase (1x frequency)																																										
3	A phase + B phase (2x frequency)																																										
4	A phase + B phase (4x frequency)																																										
Reverse setting of reference pulse signal																																											
0	Does not reverse PULS and SIGN																																										
1	Does not reverse PULS, reverse SIGN																																										
2	Reverse PULS , does not reverse SIGN																																										
3	Reverse PULS and SIGN																																										
Filter selection																																											
0	Bus driver signal reference input filter																																										
1	Collector open-circuit signal reference input filter																																										
P□201	PG frequency dividing	16 ~ 32768	1 P/rev	2500	Y																																						
P□202	First electronic gear ratio (numerator)	1 ~ 65535	—	1	Y																																						
P□203	First electronic gear ratio (denominator)	1 ~ 65535	—	1	Y																																						
P□204	Second electronic gear ratio (numerator)	1 ~ 65535	—	1	Y																																						
P□205	Position reference acceleration/deceleration time constant	0 ~ 6400	0.1ms	0	N																																						
P□206	Position reference filter form selection	0 ~ 1	—	0	Y																																						
P□300	Speed reference input gain	0 ~ 3000	(r/min)/V	150	N																																						
P□301	Internal set speed 1	0 ~ 6000	1r/min	100	N																																						
P□302	Internal set speed 2	0 ~ 6000	1r/min	200	N																																						
P□303	Internal set speed 3	0 ~ 6000	1r/min	300	N																																						
P□304	Jogging (JOG) speed	0 ~ 6000	1r/min	500	N																																						
P□305	Acceleration time of soft start	0 ~ 10000	1 ms	0	N																																						
P□306	Deceleration time of soft start	0 ~ 10000	1 ms	0	N																																						
P□307	Speed reference filter constant	0 ~ 10000	1 ms	0	N																																						
P□308	Rise time of S curve	0 ~ 10000	1 ms	0	N																																						
P□309	Speed reference curve form	—	—	0000	Y																																						

Parameter No.	Name	Setting range	Setting unit	Factory setting	Power reboot	Remarks																								
	<p>H <input type="checkbox"/> Bit 3 <input type="checkbox"/> Bit 2 <input type="checkbox"/> Bit 1 <input type="checkbox"/> Bit 0</p> <table border="1"> <thead> <tr> <th colspan="2">Soft start method</th> </tr> </thead> <tbody> <tr> <td>0</td> <td>Trapezoid</td> </tr> <tr> <td>1</td> <td>S curve</td> </tr> <tr> <td>2</td> <td>Acceleration and deceleration filter</td> </tr> </tbody> </table> <table border="1"> <thead> <tr> <th colspan="2">Acceleration and deceleration filter form</th> </tr> </thead> <tbody> <tr> <td>0</td> <td>First filter</td> </tr> <tr> <td>1</td> <td>Second filter</td> </tr> </tbody> </table> <table border="1"> <thead> <tr> <th colspan="2">Selection of S curve ratio</th> </tr> </thead> <tbody> <tr> <td>0</td> <td>Close to linearity</td> </tr> <tr> <td>1</td> <td>Low</td> </tr> <tr> <td>2</td> <td>Medium</td> </tr> <tr> <td>3</td> <td>High</td> </tr> </tbody> </table> <p>Reserved</p>	Soft start method		0	Trapezoid	1	S curve	2	Acceleration and deceleration filter	Acceleration and deceleration filter form		0	First filter	1	Second filter	Selection of S curve ratio		0	Close to linearity	1	Low	2	Medium	3	High					
Soft start method																														
0	Trapezoid																													
1	S curve																													
2	Acceleration and deceleration filter																													
Acceleration and deceleration filter form																														
0	First filter																													
1	Second filter																													
Selection of S curve ratio																														
0	Close to linearity																													
1	Low																													
2	Medium																													
3	High																													
P□400	Torque reference input gain	10 ~ 100	0.1V/rated torque	30	N																									
P□401	Torque reference filter time constant	0 ~ 250	0.1ms	4	N																									
P□402	Second torque reference filter time constant	0 ~ 250	0.1ms	4	N																									
P□403	Forward torque limit	0 ~ 300	1 %	300	N																									
P□404	Reverse torque limit	0 ~ 300	1 %	300	N																									
P□405	Forward external torque limit	0 ~ 300	1 %	100	N																									
P□406	Reverse external torque limit	0 ~ 300	1 %	100	N																									
P□407	Plug braking torque limit	0 ~ 300	1 %	300	N																									
P□408	Speed limit during torque control	0 ~ 6000	1r/min	1500	N																									
P□409	Frequency of notch filter section 1	50 ~ 5000	1Hz	5000	N																									
P□410	Depth of notch filter section 1	0 ~ 100	—	10	N																									
P□411	Frequency of notch filter section 2	50 ~ 5000	1 Hz	5000	N																									
P□412	Depth of notch filter section 2	0 ~ 100	—	10	N																									
P□413	Vibration frequency of B type	10 ~ 1000	0.1 Hz	1000	N																									
P□414	Vibration damping of B type	0 ~ 200	—	25	N																									
P□500	Positioning completion width	0 ~ 5000	1 reference unit	10	N																									
P□501	Zero clamping level	0 ~ 3000	1r/min	10	N																									
P□502	Rotation detection of electric level	0 ~ 3000	1r/min	20	N																									
P□503	Same-speed signal detection width	0 ~ 100	1r/min	10	N																									
P□504	Offset pulse overflow level	1 ~ 32767	256 reference unit	1024	N																									
P□505	Waiting time of servo ON	0 ~ 2000	ms	0	N																									
P□506	Brake command - delay time of servo OFF	0 ~ 500	10ms	0	N																									
P□507	Level for output speed of brake command	0 ~ 6000	1r/min	100	N																									

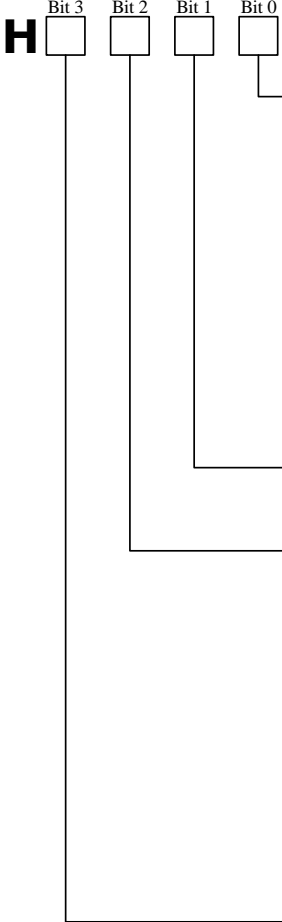
Parameter No.	Name	Setting range	Setting unit	Factory setting	Power reboot	Remarks																																																														
P□508	Brake command wait time when servo is OFF	10 ~ 100	10ms	50	N																																																															
P□509	Input signal selection 1	—	—	4321	Y	8765 (double axis/b)																																																														
 <p>/S-ON signal distribution</p> <table border="1"> <tr><td>0</td><td>Set signal fixed to be "inactive"</td></tr> <tr><td>1</td><td>Active when IN1 (CN3-14) input signal is ON</td></tr> <tr><td>2</td><td>Active when IN2 (CN3-15) input signal is ON</td></tr> <tr><td>3</td><td>Active when IN3 (CN3-16) input signal is ON</td></tr> <tr><td>4</td><td>Active when IN4 (CN3-17) input signal is ON</td></tr> <tr><td>5</td><td>Active when IN5 (CN3-39) input signal is ON</td></tr> <tr><td>6</td><td>Active when IN6 (CN3-40) input signal is ON</td></tr> <tr><td>7</td><td>Active when IN7 (CN3-41) input signal is ON</td></tr> <tr><td>8</td><td>Active when IN8 (CN3-42) input signal is ON</td></tr> <tr><td>9</td><td>Set signal fixed to be "active"</td></tr> </table> <p>/P-CON signal distribution (P control when input signal is ON)</p> <table border="1"> <tr><td>0-9</td><td>Ditto</td></tr> </table> <p>P-OT signal distribution (positive rotation drive prohibited when OFF)</p> <table border="1"> <tr><td>0</td><td>Set signal fixed to be "positive rotation drive prohibited"</td></tr> <tr><td>1</td><td>Active when IN1 (CN3-14) input signal is ON</td></tr> <tr><td>2</td><td>Active when IN2 (CN3-15) input signal is ON</td></tr> <tr><td>3</td><td>Active when IN3 (CN3-16) input signal is ON</td></tr> <tr><td>4</td><td>Active when IN4 (CN3-17) input signal is ON</td></tr> <tr><td>5</td><td>Active when IN5 (CN3-39) input signal is ON</td></tr> <tr><td>6</td><td>Active when IN6 (CN3-40) input signal is ON</td></tr> <tr><td>7</td><td>Active when IN7 (CN3-41) input signal is ON</td></tr> <tr><td>8</td><td>Active when IN8 (CN3-42) input signal is ON</td></tr> <tr><td>9</td><td>Set signal fixed to be "positive rotation drive allowed"</td></tr> </table> <p>N-OT signal distribution (negative drive prohibited when input signal is OFF)</p> <table border="1"> <tr><td>0</td><td>Set signal fixed to be "negative rotation side drive prohibited"</td></tr> <tr><td>1</td><td>Active when IN1 (CN3-14) input signal is ON</td></tr> <tr><td>2</td><td>Active when IN2 (CN3-15) input signal is ON</td></tr> <tr><td>3</td><td>Active when IN3 (CN3-16) input signal is ON</td></tr> <tr><td>4</td><td>Active when IN4 (CN3-17) input signal is ON</td></tr> <tr><td>5</td><td>Active when IN5 (CN3-39) input signal is ON</td></tr> <tr><td>6</td><td>Active when IN6 (CN3-40) input signal is ON</td></tr> <tr><td>7</td><td>Active when IN7 (CN3-41) input signal is ON</td></tr> <tr><td>8</td><td>Active when IN8 (CN3-42) input signal is ON</td></tr> <tr><td>9</td><td>Set signal fixed to be "negative rotation side drive allowed"</td></tr> </table>							0	Set signal fixed to be "inactive"	1	Active when IN1 (CN3-14) input signal is ON	2	Active when IN2 (CN3-15) input signal is ON	3	Active when IN3 (CN3-16) input signal is ON	4	Active when IN4 (CN3-17) input signal is ON	5	Active when IN5 (CN3-39) input signal is ON	6	Active when IN6 (CN3-40) input signal is ON	7	Active when IN7 (CN3-41) input signal is ON	8	Active when IN8 (CN3-42) input signal is ON	9	Set signal fixed to be "active"	0-9	Ditto	0	Set signal fixed to be "positive rotation drive prohibited"	1	Active when IN1 (CN3-14) input signal is ON	2	Active when IN2 (CN3-15) input signal is ON	3	Active when IN3 (CN3-16) input signal is ON	4	Active when IN4 (CN3-17) input signal is ON	5	Active when IN5 (CN3-39) input signal is ON	6	Active when IN6 (CN3-40) input signal is ON	7	Active when IN7 (CN3-41) input signal is ON	8	Active when IN8 (CN3-42) input signal is ON	9	Set signal fixed to be "positive rotation drive allowed"	0	Set signal fixed to be "negative rotation side drive prohibited"	1	Active when IN1 (CN3-14) input signal is ON	2	Active when IN2 (CN3-15) input signal is ON	3	Active when IN3 (CN3-16) input signal is ON	4	Active when IN4 (CN3-17) input signal is ON	5	Active when IN5 (CN3-39) input signal is ON	6	Active when IN6 (CN3-40) input signal is ON	7	Active when IN7 (CN3-41) input signal is ON	8	Active when IN8 (CN3-42) input signal is ON	9	Set signal fixed to be "negative rotation side drive allowed"
0	Set signal fixed to be "inactive"																																																																			
1	Active when IN1 (CN3-14) input signal is ON																																																																			
2	Active when IN2 (CN3-15) input signal is ON																																																																			
3	Active when IN3 (CN3-16) input signal is ON																																																																			
4	Active when IN4 (CN3-17) input signal is ON																																																																			
5	Active when IN5 (CN3-39) input signal is ON																																																																			
6	Active when IN6 (CN3-40) input signal is ON																																																																			
7	Active when IN7 (CN3-41) input signal is ON																																																																			
8	Active when IN8 (CN3-42) input signal is ON																																																																			
9	Set signal fixed to be "active"																																																																			
0-9	Ditto																																																																			
0	Set signal fixed to be "positive rotation drive prohibited"																																																																			
1	Active when IN1 (CN3-14) input signal is ON																																																																			
2	Active when IN2 (CN3-15) input signal is ON																																																																			
3	Active when IN3 (CN3-16) input signal is ON																																																																			
4	Active when IN4 (CN3-17) input signal is ON																																																																			
5	Active when IN5 (CN3-39) input signal is ON																																																																			
6	Active when IN6 (CN3-40) input signal is ON																																																																			
7	Active when IN7 (CN3-41) input signal is ON																																																																			
8	Active when IN8 (CN3-42) input signal is ON																																																																			
9	Set signal fixed to be "positive rotation drive allowed"																																																																			
0	Set signal fixed to be "negative rotation side drive prohibited"																																																																			
1	Active when IN1 (CN3-14) input signal is ON																																																																			
2	Active when IN2 (CN3-15) input signal is ON																																																																			
3	Active when IN3 (CN3-16) input signal is ON																																																																			
4	Active when IN4 (CN3-17) input signal is ON																																																																			
5	Active when IN5 (CN3-39) input signal is ON																																																																			
6	Active when IN6 (CN3-40) input signal is ON																																																																			
7	Active when IN7 (CN3-41) input signal is ON																																																																			
8	Active when IN8 (CN3-42) input signal is ON																																																																			
9	Set signal fixed to be "negative rotation side drive allowed"																																																																			

Parameter No.	Name	Setting range	Setting unit	Factory setting	Power reboot	Remarks																																	
P□510	Input signal selection 2	—	—	8765 (single axis)	Y	0000 (double axis)																																	
	<p>H Bit 3 Bit 2 Bit 1 Bit 0</p> <table border="1"> <tr><td colspan="2">/ALM-RST signal distribution (Clear alarm when turning from OFF to ON)</td></tr> <tr><td>0</td><td>Set signal fixed to be "OFF"</td></tr> <tr><td>1</td><td>Active when IN1 (CN3-14) input signal is ON</td></tr> <tr><td>2</td><td>Active when IN2 (CN3-15) input signal is ON</td></tr> <tr><td>3</td><td>Active when IN3 (CN3-16) input signal is ON</td></tr> <tr><td>4</td><td>Active when IN4 (CN3-17) input signal is ON</td></tr> <tr><td>5</td><td>Active when IN5 (CN3-39) input signal is ON</td></tr> <tr><td>6</td><td>Active when IN6 (CN3-40) input signal is ON</td></tr> <tr><td>7</td><td>Active when IN7 (CN3-41) input signal is ON</td></tr> <tr><td>8</td><td>Active when IN8 (CN3-42) input signal is ON</td></tr> <tr><td>9</td><td>Set signal fixed to be "ON"</td></tr> </table> <table border="1"> <tr><td colspan="2">/CLR signal distribution</td></tr> <tr><td>0-9</td><td>Same with /S-ON signal conversion</td></tr> </table> <table border="1"> <tr><td colspan="2">/P-CL signal distribution</td></tr> <tr><td>0-9</td><td>Ditto</td></tr> </table> <table border="1"> <tr><td colspan="2">/N-CL signal distribution</td></tr> <tr><td>0-9</td><td>Ditto</td></tr> </table>						/ALM-RST signal distribution (Clear alarm when turning from OFF to ON)		0	Set signal fixed to be "OFF"	1	Active when IN1 (CN3-14) input signal is ON	2	Active when IN2 (CN3-15) input signal is ON	3	Active when IN3 (CN3-16) input signal is ON	4	Active when IN4 (CN3-17) input signal is ON	5	Active when IN5 (CN3-39) input signal is ON	6	Active when IN6 (CN3-40) input signal is ON	7	Active when IN7 (CN3-41) input signal is ON	8	Active when IN8 (CN3-42) input signal is ON	9	Set signal fixed to be "ON"	/CLR signal distribution		0-9	Same with /S-ON signal conversion	/P-CL signal distribution		0-9	Ditto	/N-CL signal distribution		0-9
/ALM-RST signal distribution (Clear alarm when turning from OFF to ON)																																							
0	Set signal fixed to be "OFF"																																						
1	Active when IN1 (CN3-14) input signal is ON																																						
2	Active when IN2 (CN3-15) input signal is ON																																						
3	Active when IN3 (CN3-16) input signal is ON																																						
4	Active when IN4 (CN3-17) input signal is ON																																						
5	Active when IN5 (CN3-39) input signal is ON																																						
6	Active when IN6 (CN3-40) input signal is ON																																						
7	Active when IN7 (CN3-41) input signal is ON																																						
8	Active when IN8 (CN3-42) input signal is ON																																						
9	Set signal fixed to be "ON"																																						
/CLR signal distribution																																							
0-9	Same with /S-ON signal conversion																																						
/P-CL signal distribution																																							
0-9	Ditto																																						
/N-CL signal distribution																																							
0-9	Ditto																																						
P□511	Input signal selection 3	—	—	0000	Y																																		
	<p>H Bit 3 Bit 2 Bit 1 Bit 0</p> <table border="1"> <tr><td colspan="2">/G-SEL signal distribution</td></tr> <tr><td>0-9</td><td>Same with /S-ON signal conversion</td></tr> </table> <table border="1"> <tr><td colspan="2">/POS0 signal distribution</td></tr> <tr><td>0-9</td><td>Ditto</td></tr> </table> <table border="1"> <tr><td colspan="2">/POS1 signal distribution</td></tr> <tr><td>0-9</td><td>Ditto</td></tr> </table> <table border="1"> <tr><td colspan="2">/POS2 signal distribution</td></tr> <tr><td>0-9</td><td>Ditto</td></tr> </table>						/G-SEL signal distribution		0-9	Same with /S-ON signal conversion	/POS0 signal distribution		0-9	Ditto	/POS1 signal distribution		0-9	Ditto	/POS2 signal distribution		0-9	Ditto																	
/G-SEL signal distribution																																							
0-9	Same with /S-ON signal conversion																																						
/POS0 signal distribution																																							
0-9	Ditto																																						
/POS1 signal distribution																																							
0-9	Ditto																																						
/POS2 signal distribution																																							
0-9	Ditto																																						
P□512	Input signal selection 4	—	—	0000	Y																																		
	<p>H Bit 3 Bit 2 Bit 1 Bit 0</p> <table border="1"> <tr><td colspan="2">/HOME-REF</td></tr> <tr><td>0-9</td><td>Same with /S-ON signal conversion</td></tr> </table> <table border="1"> <tr><td colspan="2">/POS-START</td></tr> <tr><td>0-9</td><td>Same with /S-ON signal conversion</td></tr> </table> <table border="1"> <tr><td colspan="2">/POS-STEP</td></tr> <tr><td>0-9</td><td>Same with /S-ON signal conversion</td></tr> </table> <table border="1"> <tr><td colspan="2">/POS-START-HOME</td></tr> <tr><td>0-9</td><td>Same with /S-ON signal conversion</td></tr> </table>						/HOME-REF		0-9	Same with /S-ON signal conversion	/POS-START		0-9	Same with /S-ON signal conversion	/POS-STEP		0-9	Same with /S-ON signal conversion	/POS-START-HOME		0-9	Same with /S-ON signal conversion																	
/HOME-REF																																							
0-9	Same with /S-ON signal conversion																																						
/POS-START																																							
0-9	Same with /S-ON signal conversion																																						
/POS-STEP																																							
0-9	Same with /S-ON signal conversion																																						
/POS-START-HOME																																							
0-9	Same with /S-ON signal conversion																																						

Parameter No.	Name	Setting range	Setting unit	Factory setting	Power reboot	Remarks																											
P□513	Output signal selection 1	—	—	4321	Y	0321 (double axis/A) 0654 (double axis/b)																											
	<p>H Bit 3 Bit 2 Bit 1 Bit 0</p> <table border="1"> <thead> <tr> <th colspan="2">Servo alarm signal distribution (ALM)</th> </tr> </thead> <tbody> <tr><td>0</td><td>Inactive (not using the signal)</td></tr> <tr><td>1</td><td>Output such signal via OUT1 (CN3-7 and CN3-8)</td></tr> <tr><td>2</td><td>Output such signal via OUT2 (CN3-9 and CN3-10)</td></tr> <tr><td>3</td><td>Output such signal via OUT3 (CN3-11 and CN3-12)</td></tr> <tr><td>4</td><td>Output such signal via OUT4 (CN3-32 and CN3-33)</td></tr> <tr><td>5</td><td>Output such signal via OUT5 (CN3-34 and CN3-35)</td></tr> <tr><td>6</td><td>Output such signal via OUT6 (CN3-36 and CN3-37)</td></tr> </tbody> </table> <table border="1"> <thead> <tr> <th colspan="2">Positioning completion signal distribution (/COIN)/same-speed detection signal distribution (/V-CMP)</th> </tr> </thead> <tbody> <tr><td>0-6</td><td>Ditto</td></tr> </tbody> </table> <table border="1"> <thead> <tr> <th colspan="2">Motor rotation detection signal distribution (/TGON)</th> </tr> </thead> <tbody> <tr><td>0-6</td><td>Ditto</td></tr> </tbody> </table> <table border="1"> <thead> <tr> <th colspan="2">Servo ready signal distribution (/S-RDY)</th> </tr> </thead> <tbody> <tr><td>0-6</td><td>Ditto</td></tr> </tbody> </table>						Servo alarm signal distribution (ALM)		0	Inactive (not using the signal)	1	Output such signal via OUT1 (CN3-7 and CN3-8)	2	Output such signal via OUT2 (CN3-9 and CN3-10)	3	Output such signal via OUT3 (CN3-11 and CN3-12)	4	Output such signal via OUT4 (CN3-32 and CN3-33)	5	Output such signal via OUT5 (CN3-34 and CN3-35)	6	Output such signal via OUT6 (CN3-36 and CN3-37)	Positioning completion signal distribution (/COIN)/same-speed detection signal distribution (/V-CMP)		0-6	Ditto	Motor rotation detection signal distribution (/TGON)		0-6	Ditto	Servo ready signal distribution (/S-RDY)		0-6
Servo alarm signal distribution (ALM)																																	
0	Inactive (not using the signal)																																
1	Output such signal via OUT1 (CN3-7 and CN3-8)																																
2	Output such signal via OUT2 (CN3-9 and CN3-10)																																
3	Output such signal via OUT3 (CN3-11 and CN3-12)																																
4	Output such signal via OUT4 (CN3-32 and CN3-33)																																
5	Output such signal via OUT5 (CN3-34 and CN3-35)																																
6	Output such signal via OUT6 (CN3-36 and CN3-37)																																
Positioning completion signal distribution (/COIN)/same-speed detection signal distribution (/V-CMP)																																	
0-6	Ditto																																
Motor rotation detection signal distribution (/TGON)																																	
0-6	Ditto																																
Servo ready signal distribution (/S-RDY)																																	
0-6	Ditto																																
P□514	Output signal selection 2	—	—	0065	Y	0000 (double axis)																											
	<p>H Bit 3 Bit 2 Bit 1 Bit 0</p> <table border="1"> <thead> <tr> <th colspan="2">Torque limit output signal distribution (/CLT)</th> </tr> </thead> <tbody> <tr><td>0-6</td><td>Same with ALM signal conversion</td></tr> </tbody> </table> <table border="1"> <thead> <tr> <th colspan="2">Brake signal distribution (/BK)</th> </tr> </thead> <tbody> <tr><td>0-6</td><td>Ditto</td></tr> </tbody> </table> <table border="1"> <thead> <tr> <th colspan="2">Encoder origin signal distribution (/PGC)</th> </tr> </thead> <tbody> <tr><td>0-6</td><td>Ditto</td></tr> </tbody> </table> <table border="1"> <thead> <tr> <th colspan="2">Reserved</th> </tr> </thead> <tbody> <tr><td>0-6</td><td></td></tr> </tbody> </table>						Torque limit output signal distribution (/CLT)		0-6	Same with ALM signal conversion	Brake signal distribution (/BK)		0-6	Ditto	Encoder origin signal distribution (/PGC)		0-6	Ditto	Reserved		0-6												
Torque limit output signal distribution (/CLT)																																	
0-6	Same with ALM signal conversion																																
Brake signal distribution (/BK)																																	
0-6	Ditto																																
Encoder origin signal distribution (/PGC)																																	
0-6	Ditto																																
Reserved																																	
0-6																																	
P□515	Output signal selection 3	—	—	0000	Y																												

Parameter No.	Name	Setting range	Setting unit	Factory setting	Power reboot	Remarks
	<p>H Bit 3 Bit 2 Bit 1 Bit 0</p> <p>Current data set number bit 0 signal distribution when internal position control is in place (/InPosNum0) 0-6 Ditto</p> <p>Current data set number bit 1 signal distribution when internal position control is in place (/InPosNum1) 0-6 Ditto</p> <p>Current data set number bit 2 signal distribution when internal position control is in place (/InPosNum2) 0-6 Ditto</p> <p>Current data set number bit 3 signal distribution when internal position control is in place (/InPosNum3) 0-6 Ditto</p>					
P□516	Reserved	—	—	—	N	
P□517	Input port filter time constant	0 ~ 1000	0.1ms	1	N	
P□518	Alarm input filter time constant	0 ~ 3	0.1ms	1	N	
P□519	Active input port signal level selection 1	—	—	0000	N	
	<p>H Bit 3 Bit 2 Bit 1 Bit 0</p> <p>CN3-14 active input level selection 0 Active when input signal is ON (L level) 1 Active when input signal is OFF (H level)</p> <p>CN3-15 active input level selection 0-1 Ditto</p> <p>CN3-16 active input level selection 0-1 Ditto</p> <p>CN3-17 active input level selection 0-1 Ditto</p>					
P□520	Input port signal logic selection 2	—	—	0000	N	
	<p>H Bit 3 Bit 2 Bit 1 Bit 0</p> <p>CN3-39 active input level selection 0-1 Same with CN3-14 input level selection</p> <p>CN3-40 active input level selection 0-1 Ditto</p> <p>CN3-41 active input level selection 0-1 Ditto</p> <p>CN3-42 active input level selection 0-1 Ditto</p>					

Parameter No.	Name	Setting range	Setting unit	Factory setting	Power reboot	Remarks																																						
P□521	Output port signal reverse select 1	—	—	0000	N																																							
<p>H Bit 3 Bit 2 Bit 1 Bit 0</p> <table border="1"> <tr> <th colspan="2">OUT1 (CN3-7 and CN3-8) output reverse select</th> </tr> <tr> <td>0</td> <td>Does not invert</td> </tr> <tr> <td>1</td> <td>Invert</td> </tr> </table> <table border="1"> <tr> <th colspan="2">OUT2 (CN3-9 and CN3-10) output reverse select</th> </tr> <tr> <td>0-1</td> <td>Ditto</td> </tr> </table> <table border="1"> <tr> <th colspan="2">OUT3 (CN3-11 and CN3-12) output reverse select</th> </tr> <tr> <td>0-1</td> <td>Ditto</td> </tr> </table> <table border="1"> <tr> <th colspan="2">OUT4 (CN3-32 and CN3-33) output reverse select</th> </tr> <tr> <td>0-1</td> <td>Ditto</td> </tr> </table>							OUT1 (CN3-7 and CN3-8) output reverse select		0	Does not invert	1	Invert	OUT2 (CN3-9 and CN3-10) output reverse select		0-1	Ditto	OUT3 (CN3-11 and CN3-12) output reverse select		0-1	Ditto	OUT4 (CN3-32 and CN3-33) output reverse select		0-1	Ditto																				
OUT1 (CN3-7 and CN3-8) output reverse select																																												
0	Does not invert																																											
1	Invert																																											
OUT2 (CN3-9 and CN3-10) output reverse select																																												
0-1	Ditto																																											
OUT3 (CN3-11 and CN3-12) output reverse select																																												
0-1	Ditto																																											
OUT4 (CN3-32 and CN3-33) output reverse select																																												
0-1	Ditto																																											
P□522	Output port signal inverse select 2	—	—	0000	N																																							
<p>H Bit 3 Bit 2 Bit 1 Bit 0</p> <table border="1"> <tr> <th colspan="2">OUT5 (CN3-34 and CN3-35) output reverse select</th> </tr> <tr> <td>0-1</td> <td>Ditto</td> </tr> </table> <table border="1"> <tr> <th colspan="2">OUT6 (CN3-36 and CN3-37) output reverse select</th> </tr> <tr> <td>0-1</td> <td>Ditto</td> </tr> </table> <table border="1"> <tr> <th colspan="2">Reserved</th> </tr> </table>							OUT5 (CN3-34 and CN3-35) output reverse select		0-1	Ditto	OUT6 (CN3-36 and CN3-37) output reverse select		0-1	Ditto	Reserved																													
OUT5 (CN3-34 and CN3-35) output reverse select																																												
0-1	Ditto																																											
OUT6 (CN3-36 and CN3-37) output reverse select																																												
0-1	Ditto																																											
Reserved																																												
P□600	RS-485 communication parameter selection switch	—	—	0151	Y																																							
<p>H Bit 3 Bit 2 Bit 1 Bit 0</p> <table border="1"> <tr> <th colspan="2">Communication baud rate select</th> </tr> <tr> <td>0</td> <td>4800 bps</td> </tr> <tr> <td>1</td> <td>9600 bps</td> </tr> <tr> <td>2</td> <td>19200 bps</td> </tr> <tr> <td>3</td> <td>38400 bps</td> </tr> <tr> <td>4</td> <td>57600 bps</td> </tr> </table> <table border="1"> <tr> <th colspan="2">Communication protocol select</th> </tr> <tr> <td>0</td> <td>7, N, 2</td> <td rowspan="6">Modbus, ASCII</td> </tr> <tr> <td>1</td> <td>7, E, 1</td> </tr> <tr> <td>2</td> <td>7, O, 1</td> </tr> <tr> <td>3</td> <td>8, N, 2</td> </tr> <tr> <td>4</td> <td>8, E, 1</td> </tr> <tr> <td>5</td> <td>8, O, 1</td> </tr> <tr> <td>6</td> <td>8, N, 2</td> <td rowspan="2">Modbus, RTU</td> </tr> <tr> <td>7</td> <td>8, E, 1</td> </tr> <tr> <td>8</td> <td>8, O, 1</td> </tr> </table> <table border="1"> <tr> <th colspan="2">Reversed</th> </tr> </table> <table border="1"> <tr> <th colspan="2">Reversed</th> </tr> </table>							Communication baud rate select		0	4800 bps	1	9600 bps	2	19200 bps	3	38400 bps	4	57600 bps	Communication protocol select		0	7, N, 2	Modbus, ASCII	1	7, E, 1	2	7, O, 1	3	8, N, 2	4	8, E, 1	5	8, O, 1	6	8, N, 2	Modbus, RTU	7	8, E, 1	8	8, O, 1	Reversed		Reversed	
Communication baud rate select																																												
0	4800 bps																																											
1	9600 bps																																											
2	19200 bps																																											
3	38400 bps																																											
4	57600 bps																																											
Communication protocol select																																												
0	7, N, 2	Modbus, ASCII																																										
1	7, E, 1																																											
2	7, O, 1																																											
3	8, N, 2																																											
4	8, E, 1																																											
5	8, O, 1																																											
6	8, N, 2	Modbus, RTU																																										
7	8, E, 1																																											
8	8, O, 1																																											
Reversed																																												
Reversed																																												
P□601	RS-485 communication axis address	1 ~ 127	—	1 (A axis)	Y	2 (b axis)																																						
P□602	RS-485 communication timeout	0 ~ 1000	100 ms	0	N																																							

Parameter No.	Name	Setting range	Setting unit	Factory setting	Power reboot	Remarks																																				
	parameter																																									
P□603	Reserved	—	—	0000	N																																					
P□604	Reserved	—	—	0000	N																																					
P□605	Reserved	—	—	0000	N																																					
P□606	Reserved	—	—	0000	N																																					
P□607	Reserved	—	—	0000	N																																					
P□608	Reserved	—	—	0000	N																																					
P□609	Reserved	—	—	0000	N																																					
P□610	Type of data set 8	0 ~ 2	—	0	Y																																					
	0: data set is null 1: data set is in absolute motion 2: data set is in relative motion																																									
P□611	Low byte value of Data Set 8	-9999~+9999	1-reference pulse	0	Y																																					
P□612	High byte value of Data Set 8	-9999~+9999	10000-reference pulse	0	Y																																					
P□613	Speed of data set 8	0 ~ 6000	rpm	100	Y																																					
P□614	Step change attribute in Data Set 8	—	—	0000	Y																																					
	<p>Data set step change condition 1 type</p> <table border="1"> <tr><td>0</td><td>No condition</td></tr> <tr><td>1</td><td>Delay</td></tr> <tr><td>2</td><td>Pulse edge of signal input (/POS-STEP)</td></tr> <tr><td>3</td><td>Level of signal input (/POS-STEP)</td></tr> </table> <p>Data set step change condition 2 type</p> <table border="1"> <tr><td>0</td><td>No condition</td></tr> <tr><td>1</td><td>Delay</td></tr> <tr><td>2</td><td>Pulse edge of signal input (/POS-POS0)</td></tr> <tr><td>3</td><td>Level of signal input (/POS-POS0)</td></tr> </table> <p>Logic between step change condition 1 and 2</p> <table border="1"> <tr><td>0</td><td>No conjunction</td></tr> <tr><td>1</td><td>AND</td></tr> <tr><td>2</td><td>OR</td></tr> </table> <p>Step change transitional manner</p> <table border="1"> <tr><td>0</td><td>Aborting</td></tr> <tr><td>1</td><td>Standard</td></tr> <tr><td>2</td><td>Buffered</td></tr> <tr><td>3</td><td>BlendingLow</td></tr> <tr><td>4</td><td>BlendingPrevious</td></tr> <tr><td>5</td><td>BlendingNext</td></tr> <tr><td>6</td><td>BlendingHigh</td></tr> </table>						0	No condition	1	Delay	2	Pulse edge of signal input (/POS-STEP)	3	Level of signal input (/POS-STEP)	0	No condition	1	Delay	2	Pulse edge of signal input (/POS-POS0)	3	Level of signal input (/POS-POS0)	0	No conjunction	1	AND	2	OR	0	Aborting	1	Standard	2	Buffered	3	BlendingLow	4	BlendingPrevious	5	BlendingNext	6	BlendingHigh
0	No condition																																									
1	Delay																																									
2	Pulse edge of signal input (/POS-STEP)																																									
3	Level of signal input (/POS-STEP)																																									
0	No condition																																									
1	Delay																																									
2	Pulse edge of signal input (/POS-POS0)																																									
3	Level of signal input (/POS-POS0)																																									
0	No conjunction																																									
1	AND																																									
2	OR																																									
0	Aborting																																									
1	Standard																																									
2	Buffered																																									
3	BlendingLow																																									
4	BlendingPrevious																																									
5	BlendingNext																																									
6	BlendingHigh																																									
P□615	Step change condition value 1 in data set 8	0 ~ 65535	—	0	Y																																					
	-Unconditional: no transitional condition value - Delay: value 0 ~ 65535: latency time 0 ~ 65535, unit: ms																																									

Parameter No.	Name	Setting range	Setting unit	Factory setting	Power reboot	Remarks																																												
	- Pulse edge required for step change: Value 0: rising edge Value 1: falling edge Value 2: rising edge or falling edge - Level required for step change: Value 3: 1 level Value 4: 0 level																																																	
P□616	Step change condition value 2 in data set 8	0 ~ 65535	—	0	Y																																													
	Ditto																																																	
P□617	Follow-up data set number of data set 8	0 ~ 14	—	9	Y																																													
P□618	Type of data set 9	0 ~ 2	—	0	Y																																													
	0: data set is null 1: data set is in absolute motion 2: data set is in relative motion																																																	
P□619	Low byte value of Data Set 9	-9999~+9999	1-reference pulse	0	Y																																													
P□620	High byte value of Data Set 9	-9999~+9999	10000-reference pulse	0	Y																																													
P□621	Speed of data set 9	0 ~ 6000	rpm	100	Y																																													
P□622	Step change attribute in Data Set 9	—	—	0000	Y																																													
	<p>H <input type="checkbox"/> Bit 3 <input type="checkbox"/> Bit 2 <input type="checkbox"/> Bit 1 <input type="checkbox"/> Bit 0</p> <table border="1"> <thead> <tr> <th colspan="2">Data set step change condition 1 type</th> </tr> </thead> <tbody> <tr><td>0</td><td>No condition</td></tr> <tr><td>1</td><td>Delay</td></tr> <tr><td>2</td><td>Pulse edge of signal input (/POS-STEP)</td></tr> <tr><td>3</td><td>Level of signal input (/POS-STEP)</td></tr> </tbody> </table> <table border="1"> <thead> <tr> <th colspan="2">Data set step change condition 2 type</th> </tr> </thead> <tbody> <tr><td>0</td><td>No condition</td></tr> <tr><td>1</td><td>Delay</td></tr> <tr><td>2</td><td>Pulse edge of signal input (/POS-POS0)</td></tr> <tr><td>3</td><td>Level of signal input (/POS-POS0)</td></tr> </tbody> </table> <table border="1"> <thead> <tr> <th colspan="2">Logic between step change condition 1 and 2</th> </tr> </thead> <tbody> <tr><td>0</td><td>No conjunction</td></tr> <tr><td>1</td><td>AND</td></tr> <tr><td>2</td><td>OR</td></tr> </tbody> </table> <table border="1"> <thead> <tr> <th colspan="2">Step change transitional manner</th> </tr> </thead> <tbody> <tr><td>0</td><td>Aborting</td></tr> <tr><td>1</td><td>Standard</td></tr> <tr><td>2</td><td>Buffered</td></tr> <tr><td>3</td><td>BlendingLow</td></tr> <tr><td>4</td><td>BlendingPrevious</td></tr> <tr><td>5</td><td>BlendingNext</td></tr> <tr><td>6</td><td>BlendingHigh</td></tr> </tbody> </table>						Data set step change condition 1 type		0	No condition	1	Delay	2	Pulse edge of signal input (/POS-STEP)	3	Level of signal input (/POS-STEP)	Data set step change condition 2 type		0	No condition	1	Delay	2	Pulse edge of signal input (/POS-POS0)	3	Level of signal input (/POS-POS0)	Logic between step change condition 1 and 2		0	No conjunction	1	AND	2	OR	Step change transitional manner		0	Aborting	1	Standard	2	Buffered	3	BlendingLow	4	BlendingPrevious	5	BlendingNext	6	BlendingHigh
Data set step change condition 1 type																																																		
0	No condition																																																	
1	Delay																																																	
2	Pulse edge of signal input (/POS-STEP)																																																	
3	Level of signal input (/POS-STEP)																																																	
Data set step change condition 2 type																																																		
0	No condition																																																	
1	Delay																																																	
2	Pulse edge of signal input (/POS-POS0)																																																	
3	Level of signal input (/POS-POS0)																																																	
Logic between step change condition 1 and 2																																																		
0	No conjunction																																																	
1	AND																																																	
2	OR																																																	
Step change transitional manner																																																		
0	Aborting																																																	
1	Standard																																																	
2	Buffered																																																	
3	BlendingLow																																																	
4	BlendingPrevious																																																	
5	BlendingNext																																																	
6	BlendingHigh																																																	

Parameter No.	Name	Setting range	Setting unit	Factory setting	Power reboot	Remarks
P□623	Step change condition value 1 in data set 9	0 ~ 65535	—	0	Y	
	- Unconditional: no transitional condition value - Delay: value 0 ~ 65535: latency time0 ~ 65535, unit: ms - Pulse edge required for step change: Value 0: rising edge Value 1: falling edge Value 2: rising edge or falling edge - Level required for step change: Value 3: 1 level Value 4: 0 level					
P□624	Step change condition value 2 in data set 9	0 ~ 65535	—	0	Y	
	Ditto					
P□625	Follow-up data set number of data set 9	0 ~ 14	—	10	Y	
P□626	Type of data set 10	0 ~ 2	—	0	Y	
	0: data set is null 1: data set is in absolute motion 2: data set is in relative motion					
P□627	Low byte value of Data Set 10	-9999~+9999	1-reference pulse	0	Y	
P□628	High byte value of Data Set 10	-9999~+9999	10000-reference pulse	0	Y	
P□629	Speed of data set 10	0 ~ 6000	rpm	100	Y	
P□630	Step change attribute in Data Set 10	—	—	0000	Y	

Parameter No.	Name	Setting range	Setting unit	Factory setting	Power reboot	Remarks																																												
	<p>H</p> <p>Bit 3 Bit 2 Bit 1 Bit 0</p> <table border="1"> <thead> <tr> <th colspan="2">Data set step change condition 1 type</th> </tr> </thead> <tbody> <tr><td>0</td><td>No condition</td></tr> <tr><td>1</td><td>Delay</td></tr> <tr><td>2</td><td>Pulse edge of signal input (/POS-STEP)</td></tr> <tr><td>3</td><td>Level of signal input (/POS-STEP)</td></tr> </tbody> </table> <table border="1"> <thead> <tr> <th colspan="2">Data set step change condition 2 type</th> </tr> </thead> <tbody> <tr><td>0</td><td>No condition</td></tr> <tr><td>1</td><td>Delay</td></tr> <tr><td>2</td><td>Pulse edge of signal input (/POS-POS0)</td></tr> <tr><td>3</td><td>Level of signal input (/POS-POS0)</td></tr> </tbody> </table> <table border="1"> <thead> <tr> <th colspan="2">Logic between step change condition 1 and 2</th> </tr> </thead> <tbody> <tr><td>0</td><td>No conjunction</td></tr> <tr><td>1</td><td>AND</td></tr> <tr><td>2</td><td>OR</td></tr> </tbody> </table> <table border="1"> <thead> <tr> <th colspan="2">Step change transitional manner</th> </tr> </thead> <tbody> <tr><td>0</td><td>Aborting</td></tr> <tr><td>1</td><td>Standard</td></tr> <tr><td>2</td><td>Buffered</td></tr> <tr><td>3</td><td>BlendingLow</td></tr> <tr><td>4</td><td>BlendingPrevious</td></tr> <tr><td>5</td><td>BlendingNext</td></tr> <tr><td>6</td><td>BlendingHigh</td></tr> </tbody> </table>	Data set step change condition 1 type		0	No condition	1	Delay	2	Pulse edge of signal input (/POS-STEP)	3	Level of signal input (/POS-STEP)	Data set step change condition 2 type		0	No condition	1	Delay	2	Pulse edge of signal input (/POS-POS0)	3	Level of signal input (/POS-POS0)	Logic between step change condition 1 and 2		0	No conjunction	1	AND	2	OR	Step change transitional manner		0	Aborting	1	Standard	2	Buffered	3	BlendingLow	4	BlendingPrevious	5	BlendingNext	6	BlendingHigh					
Data set step change condition 1 type																																																		
0	No condition																																																	
1	Delay																																																	
2	Pulse edge of signal input (/POS-STEP)																																																	
3	Level of signal input (/POS-STEP)																																																	
Data set step change condition 2 type																																																		
0	No condition																																																	
1	Delay																																																	
2	Pulse edge of signal input (/POS-POS0)																																																	
3	Level of signal input (/POS-POS0)																																																	
Logic between step change condition 1 and 2																																																		
0	No conjunction																																																	
1	AND																																																	
2	OR																																																	
Step change transitional manner																																																		
0	Aborting																																																	
1	Standard																																																	
2	Buffered																																																	
3	BlendingLow																																																	
4	BlendingPrevious																																																	
5	BlendingNext																																																	
6	BlendingHigh																																																	
P□631	Step change condition value 1 in data set 10	0 ~ 65535	—	0	Y																																													
	<p>- Unconditional: no transitional condition value</p> <p>- Delay: value 0 ~ 65535: latency time 0 ~ 65535, unit: ms</p> <p>- Pulse edge required for step change:</p> <p>Value 0: rising edge</p> <p>Value 1: falling edge</p> <p>Value 2: rising edge or falling edge</p> <p>- Level required for step change:</p> <p>Value 3: 1 level</p> <p>Value 4: 0 level</p>																																																	
P□632	Step change condition value 2 in data set 10	0 ~ 65535	—	0	Y																																													
	Ditto																																																	
P□633	Follow-up data set number of data set 10	0 ~ 14	—	11	Y																																													
P□634	Type of data set 11	0 ~ 2	—	0	Y																																													
	<p>0: data set is null</p> <p>1: data set is in absolute motion</p> <p>2: data set is in relative motion</p>																																																	
P□635	Low byte value of Data Set 11	-9999~+9999	1-reference pulse	0	Y																																													

Parameter No.	Name	Setting range	Setting unit	Factory setting	Power reboot	Remarks																																											
P□636	High byte value of Data Set 11	-9999~+9999	10000-reference pulse	0	Y																																												
P□637	Speed of data set 11	0 ~ 6000	rpm	100	Y																																												
P□638	Step change attribute in Data Set 11	—	—	0000	Y																																												
	<p>H Bit 3 Bit 2 Bit 1 Bit 0</p> <table border="1"> <thead> <tr> <th colspan="2">Data set step change condition 1 type</th> </tr> </thead> <tbody> <tr><td>0</td><td>No condition</td></tr> <tr><td>1</td><td>Delay</td></tr> <tr><td>2</td><td>Pulse edge of signal input (/POS-STEP)</td></tr> <tr><td>3</td><td>Level of signal input (/POS-STEP)</td></tr> </tbody> </table> <table border="1"> <thead> <tr> <th colspan="2">Data set step change condition 2 type</th> </tr> </thead> <tbody> <tr><td>0</td><td>No condition</td></tr> <tr><td>1</td><td>Delay</td></tr> <tr><td>2</td><td>Pulse edge of signal input (/POS-POS0)</td></tr> <tr><td>3</td><td>Level of signal input (/POS-POS0)</td></tr> </tbody> </table> <table border="1"> <thead> <tr> <th colspan="2">Logic between step change condition 1 and 2</th> </tr> </thead> <tbody> <tr><td>0</td><td>No conjunction</td></tr> <tr><td>1</td><td>AND</td></tr> <tr><td>2</td><td>OR</td></tr> </tbody> </table> <table border="1"> <thead> <tr> <th colspan="2">Step change transitional manner</th> </tr> </thead> <tbody> <tr><td>0</td><td>Aborting</td></tr> <tr><td>1</td><td>Standard</td></tr> <tr><td>2</td><td>Buffered</td></tr> <tr><td>3</td><td>BlendingLow</td></tr> <tr><td>4</td><td>BlendingPrevious</td></tr> <tr><td>5</td><td>BlendingNext</td></tr> <tr><td>6</td><td>BlendingHigh</td></tr> </tbody> </table>						Data set step change condition 1 type		0	No condition	1	Delay	2	Pulse edge of signal input (/POS-STEP)	3	Level of signal input (/POS-STEP)	Data set step change condition 2 type		0	No condition	1	Delay	2	Pulse edge of signal input (/POS-POS0)	3	Level of signal input (/POS-POS0)	Logic between step change condition 1 and 2		0	No conjunction	1	AND	2	OR	Step change transitional manner		0	Aborting	1	Standard	2	Buffered	3	BlendingLow	4	BlendingPrevious	5	BlendingNext	6
Data set step change condition 1 type																																																	
0	No condition																																																
1	Delay																																																
2	Pulse edge of signal input (/POS-STEP)																																																
3	Level of signal input (/POS-STEP)																																																
Data set step change condition 2 type																																																	
0	No condition																																																
1	Delay																																																
2	Pulse edge of signal input (/POS-POS0)																																																
3	Level of signal input (/POS-POS0)																																																
Logic between step change condition 1 and 2																																																	
0	No conjunction																																																
1	AND																																																
2	OR																																																
Step change transitional manner																																																	
0	Aborting																																																
1	Standard																																																
2	Buffered																																																
3	BlendingLow																																																
4	BlendingPrevious																																																
5	BlendingNext																																																
6	BlendingHigh																																																
P□639	Step change condition value 1 in data set 11	0 ~ 65535	—	0	Y																																												
	- Unconditional: no transitional condition value - Delay: value 0 ~ 65535: latency time 0 ~ 65535, unit: ms - Pulse edge required for step change: Value 0: rising edge Value 1: falling edge Value 2: rising edge or falling edge - Level required for step change: Value 3: 1 level Value 4: 0 level																																																
P□640	Step change condition value 2 in data set 11	0 ~ 65535	—	0	Y																																												
	Ditto																																																
P□641	Follow-up data set number of data set 11	0 ~ 14	—	12	Y																																												

Parameter No.	Name	Setting range	Setting unit	Factory setting	Power reboot	Remarks																																				
P□642	Type of data set 12	0 ~ 2	—	0	Y																																					
	0: data set is null 1: data set is in absolute motion 2: data set is in relative motion																																									
P□643	Low byte value of Data Set 12	-9999~+9999	1-reference pulse	0	Y																																					
P□644	High byte value of Data Set 12	-9999~+9999	10000-reference pulse	0	Y																																					
P□645	Speed of data set 12	0 ~ 6000	rpm	100	Y																																					
P□646	Step change attribute in Data Set 12	—	—	0000	Y																																					
	<p>Data set step change condition 1 type</p> <table border="1"> <tr><td>0</td><td>No condition</td></tr> <tr><td>1</td><td>Delay</td></tr> <tr><td>2</td><td>Pulse edge of signal input (/POS-STEP)</td></tr> <tr><td>3</td><td>Level of signal input (/POS-STEP)</td></tr> </table> <p>Data set step change condition 2 type</p> <table border="1"> <tr><td>0</td><td>No condition</td></tr> <tr><td>1</td><td>Delay</td></tr> <tr><td>2</td><td>Pulse edge of signal input (/POS-POS0)</td></tr> <tr><td>3</td><td>Level of signal input (/POS-POS0)</td></tr> </table> <p>Logic between step change condition 1 and 2</p> <table border="1"> <tr><td>0</td><td>No conjunction</td></tr> <tr><td>1</td><td>AND</td></tr> <tr><td>2</td><td>OR</td></tr> </table> <p>Step change transitional manner</p> <table border="1"> <tr><td>0</td><td>Aborting</td></tr> <tr><td>1</td><td>Standard</td></tr> <tr><td>2</td><td>Buffered</td></tr> <tr><td>3</td><td>BlendingLow</td></tr> <tr><td>4</td><td>BlendingPrevious</td></tr> <tr><td>5</td><td>BlendingNext</td></tr> <tr><td>6</td><td>BlendingHigh</td></tr> </table>						0	No condition	1	Delay	2	Pulse edge of signal input (/POS-STEP)	3	Level of signal input (/POS-STEP)	0	No condition	1	Delay	2	Pulse edge of signal input (/POS-POS0)	3	Level of signal input (/POS-POS0)	0	No conjunction	1	AND	2	OR	0	Aborting	1	Standard	2	Buffered	3	BlendingLow	4	BlendingPrevious	5	BlendingNext	6	BlendingHigh
0	No condition																																									
1	Delay																																									
2	Pulse edge of signal input (/POS-STEP)																																									
3	Level of signal input (/POS-STEP)																																									
0	No condition																																									
1	Delay																																									
2	Pulse edge of signal input (/POS-POS0)																																									
3	Level of signal input (/POS-POS0)																																									
0	No conjunction																																									
1	AND																																									
2	OR																																									
0	Aborting																																									
1	Standard																																									
2	Buffered																																									
3	BlendingLow																																									
4	BlendingPrevious																																									
5	BlendingNext																																									
6	BlendingHigh																																									
P□647	Step change condition value 1 in data set 12	0 ~ 65535	—	0	Y																																					
	- Unconditional: no transitional condition value - Delay: value 0 ~ 65535: latency time 0 ~ 65535, unit: ms - Pulse edge required for step change: Value 0: rising edge Value 1: falling edge Value 2: rising edge or falling edge - Level required for step change: Value 3: 1 level Value 4: 0 level																																									

Parameter No.	Name	Setting range	Setting unit	Factory setting	Power reboot	Remarks																																											
P□648	Step change condition value 2 in data set 12	0 ~ 65535	—	0	Y																																												
	Ditto																																																
P□649	Follow-up data set number of data set 12	0 ~ 14	—	13	Y																																												
P□650	Type of data set 13	0 ~ 2	—	0	Y																																												
	0: data set is null 1: data set is in absolute motion 2: data set is in relative motion																																																
P□651	Low byte value of Data Set 13	-9999~+9999	1-reference pulse	0	Y																																												
P□652	High byte value of Data Set 13	-9999~+9999	10000-reference pulse	0	Y																																												
P□653	Speed of data set 13	0 ~ 6000	rpm	100	Y																																												
P□654	Step change attribute in Data Set 13	—	—	0000	Y																																												
	<table border="1" style="margin-left: 20px;"> <thead> <tr> <th colspan="2">Data set step change condition 1 type</th> </tr> </thead> <tbody> <tr><td>0</td><td>No condition</td></tr> <tr><td>1</td><td>Delay</td></tr> <tr><td>2</td><td>Pulse edge of signal input (/POS-STEP)</td></tr> <tr><td>3</td><td>Level of signal input (/POS-STEP)</td></tr> </tbody> </table> <table border="1" style="margin-left: 20px;"> <thead> <tr> <th colspan="2">Data set step change condition 2 type</th> </tr> </thead> <tbody> <tr><td>0</td><td>No condition</td></tr> <tr><td>1</td><td>Delay</td></tr> <tr><td>2</td><td>Pulse edge of signal input (/POS-POS0)</td></tr> <tr><td>3</td><td>Level of signal input (/POS-POS0)</td></tr> </tbody> </table> <table border="1" style="margin-left: 20px;"> <thead> <tr> <th colspan="2">Logic between step change condition 1 and 2</th> </tr> </thead> <tbody> <tr><td>0</td><td>No conjunction</td></tr> <tr><td>1</td><td>AND</td></tr> <tr><td>2</td><td>OR</td></tr> </tbody> </table> <table border="1" style="margin-left: 20px;"> <thead> <tr> <th colspan="2">Step change transitional manner</th> </tr> </thead> <tbody> <tr><td>0</td><td>Aborting</td></tr> <tr><td>1</td><td>Standard</td></tr> <tr><td>2</td><td>Buffered</td></tr> <tr><td>3</td><td>BlendingLow</td></tr> <tr><td>4</td><td>BlendingPrevious</td></tr> <tr><td>5</td><td>BlendingNext</td></tr> <tr><td>6</td><td>BlendingHigh</td></tr> </tbody> </table>						Data set step change condition 1 type		0	No condition	1	Delay	2	Pulse edge of signal input (/POS-STEP)	3	Level of signal input (/POS-STEP)	Data set step change condition 2 type		0	No condition	1	Delay	2	Pulse edge of signal input (/POS-POS0)	3	Level of signal input (/POS-POS0)	Logic between step change condition 1 and 2		0	No conjunction	1	AND	2	OR	Step change transitional manner		0	Aborting	1	Standard	2	Buffered	3	BlendingLow	4	BlendingPrevious	5	BlendingNext	6
Data set step change condition 1 type																																																	
0	No condition																																																
1	Delay																																																
2	Pulse edge of signal input (/POS-STEP)																																																
3	Level of signal input (/POS-STEP)																																																
Data set step change condition 2 type																																																	
0	No condition																																																
1	Delay																																																
2	Pulse edge of signal input (/POS-POS0)																																																
3	Level of signal input (/POS-POS0)																																																
Logic between step change condition 1 and 2																																																	
0	No conjunction																																																
1	AND																																																
2	OR																																																
Step change transitional manner																																																	
0	Aborting																																																
1	Standard																																																
2	Buffered																																																
3	BlendingLow																																																
4	BlendingPrevious																																																
5	BlendingNext																																																
6	BlendingHigh																																																
P□655	Step change condition value 1 in data set 13	0 ~ 65535	—	0	Y																																												
	- Unconditional: no transitional condition value - Delay: value 0 ~ 65535: latency time0 ~ 65535, unit: ms - Pulse edge required for step change: Value 0: rising edge																																																

Parameter No.	Name	Setting range	Setting unit	Factory setting	Power reboot	Remarks																																				
	Value 1: falling edge Value 2: rising edge or falling edge - Level required for step change: Value 3: 1 level Value 4: 0 level																																									
P□656	Step change condition value 2 in data set 13	0 ~ 65535	—	0	Y																																					
	Ditto																																									
P□657	Follow-up data set number of data set 13	0 ~ 14	—	14	Y																																					
P□658	Type of data set 14	0 ~ 2	—	0	Y																																					
	0: data set is null 1: data set is in absolute motion 2: data set is in relative motion																																									
P□659	Low byte value of Data Set 14	-9999~+9999	1-reference pulse	0	Y																																					
P□660	High byte value of Data Set 14	-9999~+9999	10000-reference pulse	0	Y																																					
P□661	Speed of data set 14	0 ~ 6000	rpm	100	Y																																					
P□662	Step change attribute in Data Set 14	—	—	0000	Y																																					
	<p>Data set step change condition 1 type</p> <table border="1"> <tr><td>0</td><td>No condition</td></tr> <tr><td>1</td><td>Delay</td></tr> <tr><td>2</td><td>Pulse edge of signal input (/POS-STEP)</td></tr> <tr><td>3</td><td>Level of signal input (/POS-STEP)</td></tr> </table> <p>Data set step change condition 2 type</p> <table border="1"> <tr><td>0</td><td>No condition</td></tr> <tr><td>1</td><td>Delay</td></tr> <tr><td>2</td><td>Pulse edge of signal input (/POS-POS0)</td></tr> <tr><td>3</td><td>Level of signal input (/POS-POS0)</td></tr> </table> <p>Logic between step change condition 1 and 2</p> <table border="1"> <tr><td>0</td><td>No conjunction</td></tr> <tr><td>1</td><td>AND</td></tr> <tr><td>2</td><td>OR</td></tr> </table> <p>Step change transitional manner</p> <table border="1"> <tr><td>0</td><td>Aborting</td></tr> <tr><td>1</td><td>Standard</td></tr> <tr><td>2</td><td>Buffered</td></tr> <tr><td>3</td><td>BlendingLow</td></tr> <tr><td>4</td><td>BlendingPrevious</td></tr> <tr><td>5</td><td>BlendingNext</td></tr> <tr><td>6</td><td>BlendingHigh</td></tr> </table>						0	No condition	1	Delay	2	Pulse edge of signal input (/POS-STEP)	3	Level of signal input (/POS-STEP)	0	No condition	1	Delay	2	Pulse edge of signal input (/POS-POS0)	3	Level of signal input (/POS-POS0)	0	No conjunction	1	AND	2	OR	0	Aborting	1	Standard	2	Buffered	3	BlendingLow	4	BlendingPrevious	5	BlendingNext	6	BlendingHigh
0	No condition																																									
1	Delay																																									
2	Pulse edge of signal input (/POS-STEP)																																									
3	Level of signal input (/POS-STEP)																																									
0	No condition																																									
1	Delay																																									
2	Pulse edge of signal input (/POS-POS0)																																									
3	Level of signal input (/POS-POS0)																																									
0	No conjunction																																									
1	AND																																									
2	OR																																									
0	Aborting																																									
1	Standard																																									
2	Buffered																																									
3	BlendingLow																																									
4	BlendingPrevious																																									
5	BlendingNext																																									
6	BlendingHigh																																									
P□663	Step change condition value 1 in	0 ~ 65535	—	0	Y																																					

Parameter No.	Name	Setting range	Setting unit	Factory setting	Power reboot	Remarks
	data set 14					
	- Unconditional: no transitional condition value - Delay: value 0 ~ 65535: latency time0 ~ 65535, unit: ms - Pulse edge required for step change: Value 0: rising edge Value 1: falling edge Value 2: rising edge or falling edge - Level required for step change: Value 3: 1 level Value 4: 0 level					
P□664	Step change condition value 2 in data set 14	0 ~ 65535	—	0	Y	
	Ditto					
P□665	Follow-up data set number of data set 14	0 ~ 14	—	0	Y	
P□700	Type of data set 0	0 ~ 2	—	0	Y	
	0: data set is null 1: data set is in absolute motion 2: data set is in relative motion					
P□701	Low byte value of Data Set 0	-9999~+9999	1-reference pulse	0	Y	
P□702	High byte value of Data Set 0	-9999~+9999	10000-reference pulse	0	Y	
P□703	Speed of data set 0	0 ~ 6000	rpm	100	Y	
P□704	Step change attribute in Data Set 0	—	—	0000	Y	

Parameter No.	Name	Setting range	Setting unit	Factory setting	Power reboot	Remarks																																												
	<p>H Bit 3 Bit 2 Bit 1 Bit 0</p> <table border="1"> <thead> <tr> <th colspan="2">Data set step change condition 1 type</th> </tr> </thead> <tbody> <tr><td>0</td><td>No condition</td></tr> <tr><td>1</td><td>Delay</td></tr> <tr><td>2</td><td>Pulse edge of signal input (/POS-STEP)</td></tr> <tr><td>3</td><td>Level of signal input (/POS-STEP)</td></tr> </tbody> </table> <table border="1"> <thead> <tr> <th colspan="2">Data set step change condition 2 type</th> </tr> </thead> <tbody> <tr><td>0</td><td>No condition</td></tr> <tr><td>1</td><td>Delay</td></tr> <tr><td>2</td><td>Pulse edge of signal input (/POS-POS0)</td></tr> <tr><td>3</td><td>Level of signal input (/POS-POS0)</td></tr> </tbody> </table> <table border="1"> <thead> <tr> <th colspan="2">Logic between step change condition 1 and 2</th> </tr> </thead> <tbody> <tr><td>0</td><td>No conjunction</td></tr> <tr><td>1</td><td>AND</td></tr> <tr><td>2</td><td>OR</td></tr> </tbody> </table> <table border="1"> <thead> <tr> <th colspan="2">Step change transitional manner</th> </tr> </thead> <tbody> <tr><td>0</td><td>Aborting</td></tr> <tr><td>1</td><td>Standard</td></tr> <tr><td>2</td><td>Buffered</td></tr> <tr><td>3</td><td>BlendingLow</td></tr> <tr><td>4</td><td>BlendingPrevious</td></tr> <tr><td>5</td><td>BlendingNext</td></tr> <tr><td>6</td><td>BlendingHigh</td></tr> </tbody> </table>	Data set step change condition 1 type		0	No condition	1	Delay	2	Pulse edge of signal input (/POS-STEP)	3	Level of signal input (/POS-STEP)	Data set step change condition 2 type		0	No condition	1	Delay	2	Pulse edge of signal input (/POS-POS0)	3	Level of signal input (/POS-POS0)	Logic between step change condition 1 and 2		0	No conjunction	1	AND	2	OR	Step change transitional manner		0	Aborting	1	Standard	2	Buffered	3	BlendingLow	4	BlendingPrevious	5	BlendingNext	6	BlendingHigh					
Data set step change condition 1 type																																																		
0	No condition																																																	
1	Delay																																																	
2	Pulse edge of signal input (/POS-STEP)																																																	
3	Level of signal input (/POS-STEP)																																																	
Data set step change condition 2 type																																																		
0	No condition																																																	
1	Delay																																																	
2	Pulse edge of signal input (/POS-POS0)																																																	
3	Level of signal input (/POS-POS0)																																																	
Logic between step change condition 1 and 2																																																		
0	No conjunction																																																	
1	AND																																																	
2	OR																																																	
Step change transitional manner																																																		
0	Aborting																																																	
1	Standard																																																	
2	Buffered																																																	
3	BlendingLow																																																	
4	BlendingPrevious																																																	
5	BlendingNext																																																	
6	BlendingHigh																																																	
P□705	Step change condition value 1 in data set 0	0 ~ 65535	—	0	Y																																													
	- Unconditional: no transitional condition value - Delay: value 0 ~ 65535: latency time 0 ~ 65535, unit: ms - Pulse edge required for step change: Value 0: rising edge Value 1: falling edge Value 2: rising edge or falling edge - Level required for step change: Value 3: 1 level Value 4: 0 level																																																	
P□706	Step change condition value 2 in data set 0	0 ~ 65535	—	0	Y																																													
	Ditto																																																	
P□707	Follow-up data set number of data set 0	0 ~ 14	—	1	Y																																													
P□708	Type of data set 1	0 ~ 2	—	0	Y																																													
	0: data set is null 1: data set is in absolute motion 2: data set is in relative motion																																																	
P□709	Low byte value of Data Set 1	-9999~+9999	1-reference pulse	0	Y																																													

Parameter No.	Name	Setting range	Setting unit	Factory setting	Power reboot	Remarks																																																				
P□710	High byte value of Data Set 1	-9999~+9999	10000-reference pulse	0	Y																																																					
P□711	Speed of data set 1	0 ~ 6000	rpm	100	Y																																																					
P□712	Step change attribute in Data Set 1	—	—	0000	Y																																																					
<div style="display: flex; align-items: flex-start;"> <div style="margin-right: 20px;"> <p>H</p> <table border="1" style="border-collapse: collapse; text-align: center;"> <tr> <td style="padding: 2px;">Bit 3</td> <td style="padding: 2px;">Bit 2</td> <td style="padding: 2px;">Bit 1</td> <td style="padding: 2px;">Bit 0</td> </tr> <tr> <td style="width: 20px; height: 20px;"></td> <td style="width: 20px; height: 20px;"></td> <td style="width: 20px; height: 20px;"></td> <td style="width: 20px; height: 20px;"></td> </tr> </table> </div> <div> <table border="1" style="border-collapse: collapse; width: 100%;"> <thead> <tr style="background-color: black; color: white;"> <th colspan="2">Data set step change condition 1 type</th> </tr> </thead> <tbody> <tr><td style="text-align: center;">0</td><td>No condition</td></tr> <tr><td style="text-align: center;">1</td><td>Delay</td></tr> <tr><td style="text-align: center;">2</td><td>Pulse edge of signal input (/POS-STEP)</td></tr> <tr><td style="text-align: center;">3</td><td>Level of signal input (/POS-STEP)</td></tr> </tbody> </table> <table border="1" style="border-collapse: collapse; width: 100%;"> <thead> <tr style="background-color: black; color: white;"> <th colspan="2">Data set step change condition 2 type</th> </tr> </thead> <tbody> <tr><td style="text-align: center;">0</td><td>No condition</td></tr> <tr><td style="text-align: center;">1</td><td>Delay</td></tr> <tr><td style="text-align: center;">2</td><td>Pulse edge of signal input (/POS-POS0)</td></tr> <tr><td style="text-align: center;">3</td><td>Level of signal input (/POS-POS0)</td></tr> </tbody> </table> <table border="1" style="border-collapse: collapse; width: 100%;"> <thead> <tr style="background-color: black; color: white;"> <th colspan="2">Logic between step change condition 1 and 2</th> </tr> </thead> <tbody> <tr><td style="text-align: center;">0</td><td>No conjunction</td></tr> <tr><td style="text-align: center;">1</td><td>AND</td></tr> <tr><td style="text-align: center;">2</td><td>OR</td></tr> </tbody> </table> <table border="1" style="border-collapse: collapse; width: 100%;"> <thead> <tr style="background-color: black; color: white;"> <th colspan="2">Step change transitional manner</th> </tr> </thead> <tbody> <tr><td style="text-align: center;">0</td><td>Aborting</td></tr> <tr><td style="text-align: center;">1</td><td>Standard</td></tr> <tr><td style="text-align: center;">2</td><td>Buffered</td></tr> <tr><td style="text-align: center;">3</td><td>BlendingLow</td></tr> <tr><td style="text-align: center;">4</td><td>BlendingPrevious</td></tr> <tr><td style="text-align: center;">5</td><td>BlendingNext</td></tr> <tr><td style="text-align: center;">6</td><td>BlendingHigh</td></tr> </tbody> </table> </div> </div>							Bit 3	Bit 2	Bit 1	Bit 0					Data set step change condition 1 type		0	No condition	1	Delay	2	Pulse edge of signal input (/POS-STEP)	3	Level of signal input (/POS-STEP)	Data set step change condition 2 type		0	No condition	1	Delay	2	Pulse edge of signal input (/POS-POS0)	3	Level of signal input (/POS-POS0)	Logic between step change condition 1 and 2		0	No conjunction	1	AND	2	OR	Step change transitional manner		0	Aborting	1	Standard	2	Buffered	3	BlendingLow	4	BlendingPrevious	5	BlendingNext	6	BlendingHigh
Bit 3	Bit 2	Bit 1	Bit 0																																																							
Data set step change condition 1 type																																																										
0	No condition																																																									
1	Delay																																																									
2	Pulse edge of signal input (/POS-STEP)																																																									
3	Level of signal input (/POS-STEP)																																																									
Data set step change condition 2 type																																																										
0	No condition																																																									
1	Delay																																																									
2	Pulse edge of signal input (/POS-POS0)																																																									
3	Level of signal input (/POS-POS0)																																																									
Logic between step change condition 1 and 2																																																										
0	No conjunction																																																									
1	AND																																																									
2	OR																																																									
Step change transitional manner																																																										
0	Aborting																																																									
1	Standard																																																									
2	Buffered																																																									
3	BlendingLow																																																									
4	BlendingPrevious																																																									
5	BlendingNext																																																									
6	BlendingHigh																																																									
P□713	Step change condition value 1 in data set 1	0 ~ 65535	—	0	Y																																																					
<p>- Unconditional: no transitional condition value</p> <p>- Delay: value 0 ~ 65535: latency time0 ~ 65535, unit: ms</p> <p>- Pulse edge required for step change:</p> <p style="margin-left: 20px;">Value 0: rising edge</p> <p style="margin-left: 20px;">Value 1: falling edge</p> <p style="margin-left: 20px;">Value 2: rising edge or falling edge</p> <p>- Level required for step change:</p> <p style="margin-left: 20px;">Value 3: 1 level</p> <p style="margin-left: 20px;">Value 4: 0 level</p>																																																										
P□714	Step change condition value 2 in data set 1	0 ~ 65535	—	0	Y																																																					
Ditto																																																										
P□715	Follow-up data set number of data set 1	0 ~ 14	—	2	Y																																																					
P□716	Type of data set 2	0 ~ 2	—	0	Y																																																					

Parameter No.	Name	Setting range	Setting unit	Factory setting	Power reboot	Remarks																																				
	0: data set is null 1: data set is in absolute motion 2: data set is in relative motion																																									
P□717	Low byte value of Data Set 2	-9999~+9999	1-reference pulse	0	Y																																					
P□718	High byte value of Data Set 2	-9999~+9999	10000-reference pulse	0	Y																																					
P□719	Speed of data set 2	0 ~ 6000	rpm	100	Y																																					
P□720	Step change attribute in Data Set 2	—	—	0000	Y																																					
	<p>Data set step change condition 1 type</p> <table border="1"> <tr><td>0</td><td>No condition</td></tr> <tr><td>1</td><td>Delay</td></tr> <tr><td>2</td><td>Pulse edge of signal input (/POS-STEP)</td></tr> <tr><td>3</td><td>Level of signal input (/POS-STEP)</td></tr> </table> <p>Data set step change condition 2 type</p> <table border="1"> <tr><td>0</td><td>No condition</td></tr> <tr><td>1</td><td>Delay</td></tr> <tr><td>2</td><td>Pulse edge of signal input (/POS-POS0)</td></tr> <tr><td>3</td><td>Level of signal input (/POS-POS0)</td></tr> </table> <p>Logic between step change condition 1 and 2</p> <table border="1"> <tr><td>0</td><td>No conjunction</td></tr> <tr><td>1</td><td>AND</td></tr> <tr><td>2</td><td>OR</td></tr> </table> <p>Step change transitional manner</p> <table border="1"> <tr><td>0</td><td>Aborting</td></tr> <tr><td>1</td><td>Standard</td></tr> <tr><td>2</td><td>Buffered</td></tr> <tr><td>3</td><td>BlendingLow</td></tr> <tr><td>4</td><td>BlendingPrevious</td></tr> <tr><td>5</td><td>BlendingNext</td></tr> <tr><td>6</td><td>BlendingHigh</td></tr> </table>						0	No condition	1	Delay	2	Pulse edge of signal input (/POS-STEP)	3	Level of signal input (/POS-STEP)	0	No condition	1	Delay	2	Pulse edge of signal input (/POS-POS0)	3	Level of signal input (/POS-POS0)	0	No conjunction	1	AND	2	OR	0	Aborting	1	Standard	2	Buffered	3	BlendingLow	4	BlendingPrevious	5	BlendingNext	6	BlendingHigh
0	No condition																																									
1	Delay																																									
2	Pulse edge of signal input (/POS-STEP)																																									
3	Level of signal input (/POS-STEP)																																									
0	No condition																																									
1	Delay																																									
2	Pulse edge of signal input (/POS-POS0)																																									
3	Level of signal input (/POS-POS0)																																									
0	No conjunction																																									
1	AND																																									
2	OR																																									
0	Aborting																																									
1	Standard																																									
2	Buffered																																									
3	BlendingLow																																									
4	BlendingPrevious																																									
5	BlendingNext																																									
6	BlendingHigh																																									
P□721	Step change condition value 1 in data set 2	0 ~ 65535	—	0	Y																																					
	- Unconditional: no transitional condition value - Delay: value 0 ~ 65535: latency time0 ~ 65535, unit: ms - Pulse edge required for step change: Value 0: rising edge Value 1: falling edge Value 2: rising edge or falling edge - Level required for step change: Value 3: 1 level Value 4: 0 level																																									
P□722	Step change condition value 2 in data set 2	0 ~ 65535	—	0	Y																																					

Parameter No.	Name	Setting range	Setting unit	Factory setting	Power reboot	Remarks																																				
	Ditto																																									
P□723	Follow-up data set number of data set 2	0 ~ 14	—	3	Y																																					
P□724	Type of data set 3	0 ~ 2	—	0	Y																																					
	0: data set is null 1: data set is in absolute motion 2: data set is in relative motion																																									
P□725	Low byte value of Data Set 3	-9999~+9999	1-reference pulse	0	Y																																					
P□726	High byte value of Data Set 3	-9999~+9999	10000-reference pulse	0	Y																																					
P□727	Speed of data set 3	0 ~ 6000	rpm	100	Y																																					
P□728	Step change attribute in Data Set 3	—	—	0000	Y																																					
	<p>Data set step change condition 1 type</p> <table border="1"> <tr><td>0</td><td>No condition</td></tr> <tr><td>1</td><td>Delay</td></tr> <tr><td>2</td><td>Pulse edge of signal input (/POS-STEP)</td></tr> <tr><td>3</td><td>Level of signal input (/POS-STEP)</td></tr> </table> <p>Data set step change condition 2 type</p> <table border="1"> <tr><td>0</td><td>No condition</td></tr> <tr><td>1</td><td>Delay</td></tr> <tr><td>2</td><td>Pulse edge of signal input (/POS-POS0)</td></tr> <tr><td>3</td><td>Level of signal input (/POS-POS0)</td></tr> </table> <p>Logic between step change condition 1 and 2</p> <table border="1"> <tr><td>0</td><td>No conjunction</td></tr> <tr><td>1</td><td>AND</td></tr> <tr><td>2</td><td>OR</td></tr> </table> <p>Step change transitional manner</p> <table border="1"> <tr><td>0</td><td>Aborting</td></tr> <tr><td>1</td><td>Standard</td></tr> <tr><td>2</td><td>Buffered</td></tr> <tr><td>3</td><td>BlendingLow</td></tr> <tr><td>4</td><td>BlendingPrevious</td></tr> <tr><td>5</td><td>BlendingNext</td></tr> <tr><td>6</td><td>BlendingHigh</td></tr> </table>						0	No condition	1	Delay	2	Pulse edge of signal input (/POS-STEP)	3	Level of signal input (/POS-STEP)	0	No condition	1	Delay	2	Pulse edge of signal input (/POS-POS0)	3	Level of signal input (/POS-POS0)	0	No conjunction	1	AND	2	OR	0	Aborting	1	Standard	2	Buffered	3	BlendingLow	4	BlendingPrevious	5	BlendingNext	6	BlendingHigh
0	No condition																																									
1	Delay																																									
2	Pulse edge of signal input (/POS-STEP)																																									
3	Level of signal input (/POS-STEP)																																									
0	No condition																																									
1	Delay																																									
2	Pulse edge of signal input (/POS-POS0)																																									
3	Level of signal input (/POS-POS0)																																									
0	No conjunction																																									
1	AND																																									
2	OR																																									
0	Aborting																																									
1	Standard																																									
2	Buffered																																									
3	BlendingLow																																									
4	BlendingPrevious																																									
5	BlendingNext																																									
6	BlendingHigh																																									
P□729	Step change condition value 1 in data set 3	0 ~ 65535	—	0	Y																																					
	- Unconditional: no transitional condition value - Delay: value 0 ~ 65535: latency time0 ~ 65535, unit: ms - Pulse edge required for step change: Value 0: rising edge Value 1: falling edge Value 2: rising edge or falling edge - Level required for step change:																																									

Parameter No.	Name	Setting range	Setting unit	Factory setting	Power reboot	Remarks																																												
	Value 3: 1 level Value 4: 0 level																																																	
P□730	Step change condition value 2 in data set 3 Ditto	0 ~ 65535	—	0	Y																																													
P□731	Follow-up data set number of data set 3	0 ~ 14	—	4	Y																																													
P□732	Type of data set 4 0: data set is null 1: data set is in absolute motion 2: data set is in relative motion	0 ~ 2	—	0	Y																																													
P□733	Low byte value of Data Set 4	-9999~+9999	1-reference pulse	0	Y																																													
P□734	High byte value of Data Set 4	-9999~+9999	10000-reference pulse	0	Y																																													
P□735	Speed of data set 4	0 ~ 6000	rpm	100	Y																																													
P□736	Step change attribute in Data Set 4 H <input type="checkbox"/> Bit 3 <input type="checkbox"/> Bit 2 <input type="checkbox"/> Bit 1 <input type="checkbox"/> Bit 0	—	—	0000	Y	<table border="1"> <thead> <tr> <th colspan="2">Data set step change condition 1 type</th> </tr> </thead> <tbody> <tr><td>0</td><td>No condition</td></tr> <tr><td>1</td><td>Delay</td></tr> <tr><td>2</td><td>Pulse edge of signal input (/POS-STEP)</td></tr> <tr><td>3</td><td>Level of signal input (/POS-STEP)</td></tr> </tbody> </table> <table border="1"> <thead> <tr> <th colspan="2">Data set step change condition 2 type</th> </tr> </thead> <tbody> <tr><td>0</td><td>No condition</td></tr> <tr><td>1</td><td>Delay</td></tr> <tr><td>2</td><td>Pulse edge of signal input (/POS-POS0)</td></tr> <tr><td>3</td><td>Level of signal input (/POS-POS0)</td></tr> </tbody> </table> <table border="1"> <thead> <tr> <th colspan="2">Logic between step change condition 1 and 2</th> </tr> </thead> <tbody> <tr><td>0</td><td>No conjunction</td></tr> <tr><td>1</td><td>AND</td></tr> <tr><td>2</td><td>OR</td></tr> </tbody> </table> <table border="1"> <thead> <tr> <th colspan="2">Step change transitional manner</th> </tr> </thead> <tbody> <tr><td>0</td><td>Aborting</td></tr> <tr><td>1</td><td>Standard</td></tr> <tr><td>2</td><td>Buffered</td></tr> <tr><td>3</td><td>BlendingLow</td></tr> <tr><td>4</td><td>BlendingPrevious</td></tr> <tr><td>5</td><td>BlendingNext</td></tr> <tr><td>6</td><td>BlendingHigh</td></tr> </tbody> </table>	Data set step change condition 1 type		0	No condition	1	Delay	2	Pulse edge of signal input (/POS-STEP)	3	Level of signal input (/POS-STEP)	Data set step change condition 2 type		0	No condition	1	Delay	2	Pulse edge of signal input (/POS-POS0)	3	Level of signal input (/POS-POS0)	Logic between step change condition 1 and 2		0	No conjunction	1	AND	2	OR	Step change transitional manner		0	Aborting	1	Standard	2	Buffered	3	BlendingLow	4	BlendingPrevious	5	BlendingNext	6	BlendingHigh
Data set step change condition 1 type																																																		
0	No condition																																																	
1	Delay																																																	
2	Pulse edge of signal input (/POS-STEP)																																																	
3	Level of signal input (/POS-STEP)																																																	
Data set step change condition 2 type																																																		
0	No condition																																																	
1	Delay																																																	
2	Pulse edge of signal input (/POS-POS0)																																																	
3	Level of signal input (/POS-POS0)																																																	
Logic between step change condition 1 and 2																																																		
0	No conjunction																																																	
1	AND																																																	
2	OR																																																	
Step change transitional manner																																																		
0	Aborting																																																	
1	Standard																																																	
2	Buffered																																																	
3	BlendingLow																																																	
4	BlendingPrevious																																																	
5	BlendingNext																																																	
6	BlendingHigh																																																	
P□737	Step change condition value 1 in data set 4 - Unconditional: no transitional condition value - Delay: value 0 ~ 65535: latency time0 ~ 65535, unit: ms - Pulse edge required for step change:	0 ~ 65535	—	0	Y																																													

Parameter No.	Name	Setting range	Setting unit	Factory setting	Power reboot	Remarks																																												
	Value 0: rising edge Value 1: falling edge Value 2: rising edge or falling edge - Level required for step change: Value 3: 1 level Value 4: 0 level																																																	
P□738	Step change condition value 2 in data set 4	0 ~ 65535	—	0	Y																																													
	Ditto																																																	
P□739	Follow-up data set number of data set 4	0 ~ 14	—	5	Y																																													
P□740	Type of data set 5	0 ~ 2	—	0	Y																																													
	0: data set is null 1: data set is in absolute motion 2: data set is in relative motion																																																	
P□741	Low byte value of Data Set 5	-9999~+9999	1-reference pulse	0	Y																																													
P□742	High byte value of Data Set 5	-9999~+9999	10000-reference pulse	0	Y																																													
P□743	Speed of data set 5	0 ~ 6000	rpm	100	Y																																													
	Step change attribute in Data Set 5	—	—	0000	Y																																													
P□744	<p>H Bit 3 Bit 2 Bit 1 Bit 0</p> <table border="1"> <thead> <tr> <th colspan="2">Data set step change condition 1 type</th> </tr> </thead> <tbody> <tr><td>0</td><td>No condition</td></tr> <tr><td>1</td><td>Delay</td></tr> <tr><td>2</td><td>Pulse edge of signal input (/POS-STEP)</td></tr> <tr><td>3</td><td>Level of signal input (/POS-STEP)</td></tr> </tbody> </table> <table border="1"> <thead> <tr> <th colspan="2">Data set step change condition 2 type</th> </tr> </thead> <tbody> <tr><td>0</td><td>No condition</td></tr> <tr><td>1</td><td>Delay</td></tr> <tr><td>2</td><td>Pulse edge of signal input (/POS-POS0)</td></tr> <tr><td>3</td><td>Level of signal input (/POS-POS0)</td></tr> </tbody> </table> <table border="1"> <thead> <tr> <th colspan="2">Logic between step change condition 1 and 2</th> </tr> </thead> <tbody> <tr><td>0</td><td>No conjunction</td></tr> <tr><td>1</td><td>AND</td></tr> <tr><td>2</td><td>OR</td></tr> </tbody> </table> <table border="1"> <thead> <tr> <th colspan="2">Step change transitional manner</th> </tr> </thead> <tbody> <tr><td>0</td><td>Aborting</td></tr> <tr><td>1</td><td>Standard</td></tr> <tr><td>2</td><td>Buffered</td></tr> <tr><td>3</td><td>BlendingLow</td></tr> <tr><td>4</td><td>BlendingPrevious</td></tr> <tr><td>5</td><td>BlendingNext</td></tr> <tr><td>6</td><td>BlendingHigh</td></tr> </tbody> </table>						Data set step change condition 1 type		0	No condition	1	Delay	2	Pulse edge of signal input (/POS-STEP)	3	Level of signal input (/POS-STEP)	Data set step change condition 2 type		0	No condition	1	Delay	2	Pulse edge of signal input (/POS-POS0)	3	Level of signal input (/POS-POS0)	Logic between step change condition 1 and 2		0	No conjunction	1	AND	2	OR	Step change transitional manner		0	Aborting	1	Standard	2	Buffered	3	BlendingLow	4	BlendingPrevious	5	BlendingNext	6	BlendingHigh
Data set step change condition 1 type																																																		
0	No condition																																																	
1	Delay																																																	
2	Pulse edge of signal input (/POS-STEP)																																																	
3	Level of signal input (/POS-STEP)																																																	
Data set step change condition 2 type																																																		
0	No condition																																																	
1	Delay																																																	
2	Pulse edge of signal input (/POS-POS0)																																																	
3	Level of signal input (/POS-POS0)																																																	
Logic between step change condition 1 and 2																																																		
0	No conjunction																																																	
1	AND																																																	
2	OR																																																	
Step change transitional manner																																																		
0	Aborting																																																	
1	Standard																																																	
2	Buffered																																																	
3	BlendingLow																																																	
4	BlendingPrevious																																																	
5	BlendingNext																																																	
6	BlendingHigh																																																	
P□745	Step change condition value 1 in	0 ~ 65535	—	0	Y																																													

Parameter No.	Name	Setting range	Setting unit	Factory setting	Power reboot	Remarks
	data set 5					
	- Unconditional: no transitional condition value - Delay: value 0 ~ 65535: latency time0 ~ 65535, unit: ms - Pulse edge required for step change: Value 0: rising edge Value 1: falling edge Value 2: rising edge or falling edge - Level required for step change: Value 3: 1 level Value 4: 0 level					
P□746	Step change condition value 2 in data set 5	0 ~ 65535	—	0	Y	
	Ditto					
P□747	Follow-up data set number of data set 5	0 ~ 14	—	6	Y	
	Type of data set 6	0 ~ 2	—	0	Y	
P□748	0: data set is null 1: data set is in absolute motion 2: data set is in relative motion					
P□749	Low byte value of Data Set 6	-9999~+9999	1-reference pulse	0	Y	
P□750	High byte value of Data Set 6	-9999~+9999	10000-reference pulse	0	Y	
P□751	Speed of data set 6	0 ~ 6000	rpm	100	Y	
P□752	Step change attribute in Data Set 6	—	—	0000	Y	

Parameter No.	Name	Setting range	Setting unit	Factory setting	Power reboot	Remarks																																												
	<p>H <input type="checkbox"/> Bit 3 <input type="checkbox"/> Bit 2 <input type="checkbox"/> Bit 1 <input type="checkbox"/> Bit 0</p> <table border="1"> <thead> <tr> <th colspan="2">Data set step change condition 1 type</th> </tr> </thead> <tbody> <tr><td>0</td><td>No condition</td></tr> <tr><td>1</td><td>Delay</td></tr> <tr><td>2</td><td>Pulse edge of signal input (/POS-STEP)</td></tr> <tr><td>3</td><td>Level of signal input (/POS-STEP)</td></tr> </tbody> </table> <table border="1"> <thead> <tr> <th colspan="2">Data set step change condition 2 type</th> </tr> </thead> <tbody> <tr><td>0</td><td>No condition</td></tr> <tr><td>1</td><td>Delay</td></tr> <tr><td>2</td><td>Pulse edge of signal input (/POS-POS0)</td></tr> <tr><td>3</td><td>Level of signal input (/POS-POS0)</td></tr> </tbody> </table> <table border="1"> <thead> <tr> <th colspan="2">Logic between step change condition 1 and 2</th> </tr> </thead> <tbody> <tr><td>0</td><td>No conjunction</td></tr> <tr><td>1</td><td>AND</td></tr> <tr><td>2</td><td>OR</td></tr> </tbody> </table> <table border="1"> <thead> <tr> <th colspan="2">Step change transitional manner</th> </tr> </thead> <tbody> <tr><td>0</td><td>Aborting</td></tr> <tr><td>1</td><td>Standard</td></tr> <tr><td>2</td><td>Buffered</td></tr> <tr><td>3</td><td>BlendingLow</td></tr> <tr><td>4</td><td>BlendingPrevious</td></tr> <tr><td>5</td><td>BlendingNext</td></tr> <tr><td>6</td><td>BlendingHigh</td></tr> </tbody> </table>	Data set step change condition 1 type		0	No condition	1	Delay	2	Pulse edge of signal input (/POS-STEP)	3	Level of signal input (/POS-STEP)	Data set step change condition 2 type		0	No condition	1	Delay	2	Pulse edge of signal input (/POS-POS0)	3	Level of signal input (/POS-POS0)	Logic between step change condition 1 and 2		0	No conjunction	1	AND	2	OR	Step change transitional manner		0	Aborting	1	Standard	2	Buffered	3	BlendingLow	4	BlendingPrevious	5	BlendingNext	6	BlendingHigh					
Data set step change condition 1 type																																																		
0	No condition																																																	
1	Delay																																																	
2	Pulse edge of signal input (/POS-STEP)																																																	
3	Level of signal input (/POS-STEP)																																																	
Data set step change condition 2 type																																																		
0	No condition																																																	
1	Delay																																																	
2	Pulse edge of signal input (/POS-POS0)																																																	
3	Level of signal input (/POS-POS0)																																																	
Logic between step change condition 1 and 2																																																		
0	No conjunction																																																	
1	AND																																																	
2	OR																																																	
Step change transitional manner																																																		
0	Aborting																																																	
1	Standard																																																	
2	Buffered																																																	
3	BlendingLow																																																	
4	BlendingPrevious																																																	
5	BlendingNext																																																	
6	BlendingHigh																																																	
P□753	Step change condition value 1 in data set 6	0 ~ 65535	—	0	Y																																													
	<ul style="list-style-type: none"> - Unconditional: no transitional condition value - Delay: value 0 ~ 65535: latency time0 ~ 65535, unit: ms - Pulse edge required for step change: <ul style="list-style-type: none"> Value 0: rising edge Value 1: falling edge Value 2: rising edge or falling edge - Level required for step change: <ul style="list-style-type: none"> Value 3: 1 level Value 4: 0 level 																																																	
P□754	Step change condition value 2 in data set 6	0 ~ 65535	—	0	Y																																													
	Ditto																																																	
P□755	Follow-up data set number of data set 6	0 ~ 14	—	7	Y																																													
P□756	Type of data set 7	0 ~ 2	—	0	Y																																													
	<ul style="list-style-type: none"> 0: data set is null 1: data set is in absolute motion 2: data set is in relative motion 																																																	
P□757	Low byte value of Data Set 7	-9999~+9999	1-reference pulse	0	Y																																													

Parameter No.	Name	Setting range	Setting unit	Factory setting	Power reboot	Remarks																																				
P□758	High byte value of Data Set 7	-9999~+9999	10000-reference pulse	0	Y																																					
P□759	Speed of data set 7	0 ~ 6000	rpm	100	Y																																					
P□760	Step change attribute in Data Set 7	—	—	0000	Y																																					
	<p>Data set step change condition 1 type</p> <table border="1"> <tr><td>0</td><td>No condition</td></tr> <tr><td>1</td><td>Delay</td></tr> <tr><td>2</td><td>Pulse edge of signal input (/POS-STEP)</td></tr> <tr><td>3</td><td>Level of signal input (/POS-STEP)</td></tr> </table> <p>Data set step change condition 2 type</p> <table border="1"> <tr><td>0</td><td>No condition</td></tr> <tr><td>1</td><td>Delay</td></tr> <tr><td>2</td><td>Pulse edge of signal input (/POS-POS0)</td></tr> <tr><td>3</td><td>Level of signal input (/POS-POS0)</td></tr> </table> <p>Logic between step change condition 1 and 2</p> <table border="1"> <tr><td>0</td><td>No conjunction</td></tr> <tr><td>1</td><td>AND</td></tr> <tr><td>2</td><td>OR</td></tr> </table> <p>Step change transitional manner</p> <table border="1"> <tr><td>0</td><td>Aborting</td></tr> <tr><td>1</td><td>Standard</td></tr> <tr><td>2</td><td>Buffered</td></tr> <tr><td>3</td><td>BlendingLow</td></tr> <tr><td>4</td><td>BlendingPrevious</td></tr> <tr><td>5</td><td>BlendingNext</td></tr> <tr><td>6</td><td>BlendingHigh</td></tr> </table>						0	No condition	1	Delay	2	Pulse edge of signal input (/POS-STEP)	3	Level of signal input (/POS-STEP)	0	No condition	1	Delay	2	Pulse edge of signal input (/POS-POS0)	3	Level of signal input (/POS-POS0)	0	No conjunction	1	AND	2	OR	0	Aborting	1	Standard	2	Buffered	3	BlendingLow	4	BlendingPrevious	5	BlendingNext	6	BlendingHigh
0	No condition																																									
1	Delay																																									
2	Pulse edge of signal input (/POS-STEP)																																									
3	Level of signal input (/POS-STEP)																																									
0	No condition																																									
1	Delay																																									
2	Pulse edge of signal input (/POS-POS0)																																									
3	Level of signal input (/POS-POS0)																																									
0	No conjunction																																									
1	AND																																									
2	OR																																									
0	Aborting																																									
1	Standard																																									
2	Buffered																																									
3	BlendingLow																																									
4	BlendingPrevious																																									
5	BlendingNext																																									
6	BlendingHigh																																									
P□761	Step change condition value 1 in data set 7	0 ~ 65535	—	0	Y																																					
	<ul style="list-style-type: none"> - Unconditional: no transitional condition value - Delay: value 0 ~ 65535: latency time0 ~ 65535, unit: ms - Pulse edge required for step change: <ul style="list-style-type: none"> Value 0: rising edge Value 1: falling edge Value 2: rising edge or falling edge - Level required for step change: <ul style="list-style-type: none"> Value 3: 1 level Value 4: 0 level 																																									
P□762	Step change condition value 2 in data set 7	0 ~ 65535	—	0	Y																																					
	Ditto																																									
P□763	Follow-up data set number of data set 7	0 ~ 14f	—	0	Y																																					
P□764	Data set start method	0 ~ 1	—	0	Y																																					

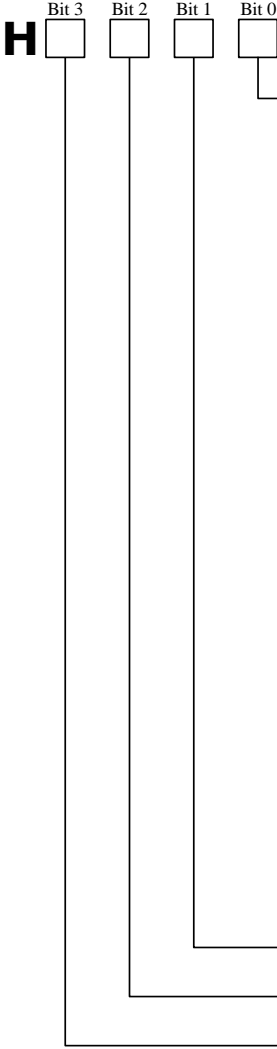
Parameter No.	Name	Setting range	Setting unit	Factory setting	Power reboot	Remarks																																						
	0: internal method (single data set method) 1: task mode (data set sequence)																																											
P□765	Acceleration of data set	0 ~ 60000	10 rpm/s	10000	Y																																							
P□766	Deceleration of data set	0 ~ 60000	10 rpm/s	10000	Y																																							
P□767	Emergency deceleration of data set	0 ~ 60000	10 rpm/s	60000	Y																																							
P□768	Data set position electronic gear ratio (numerator)	1 ~ 65535	—	1	Y																																							
P□769	Data set position electronic gear ratio (denominator)	1 ~ 65535	—	1	Y																																							
	Zero returning method selection switch	—	—	0000	Y																																							
P□770	 <table border="1" style="margin-left: 20px;"> <thead> <tr> <th colspan="2">Zero returning method setting</th> </tr> </thead> <tbody> <tr><td>0</td><td>DS402 METHOD 35 (set current position as zero point)</td></tr> <tr><td>1</td><td>DS402 METHOD 1 (for on-off operation of seeking for NOT switch in the reverse direction, C pulse is required)</td></tr> <tr><td>2</td><td>DS402 METHOD 2 (for on-off operation of seeking for POT switch in the forward direction, C pulse is required)</td></tr> <tr><td>3</td><td>DS402 METHOD 3 (for on-off operation of seeking for reference point switch in the forward direction, C pulse is required)</td></tr> <tr><td>4</td><td>DS402 METHOD 4 (for on-off operation of seeking for reference point switch in the forward direction, C pulse is required)</td></tr> <tr><td>5</td><td>DS402 METHOD 5 (for on-off operation of seeking for reference point switch in the reverse direction, C pulse is required)</td></tr> <tr><td>6</td><td>DS402 METHOD 6 (for on-off operation of seeking for reference point switch in the reverse direction, C pulse is required)</td></tr> <tr><td>7</td><td>DS402 METHOD 17 (for on-off operation of seeking for NOT switch in the reverse direction, C pulse is not required)</td></tr> <tr><td>8</td><td>DS402 METHOD 18 (for on-off operation of seeking for POT switch in the forward direction, C pulse is not required)</td></tr> <tr><td>9</td><td>DS402 METHOD 19 (for on-off operation of seeking for reference point switch in the forward direction, C pulse is not required)</td></tr> <tr><td>10</td><td>DS402 METHOD 20 (for on-off operation of seeking for reference point switch in the forward direction, C pulse is not required)</td></tr> <tr><td>11</td><td>DS402 METHOD 21 (for on-off operation of seeking for reference point switch in the reverse direction, C pulse is not required)</td></tr> <tr><td>12</td><td>DS402 METHOD 22 (for on-off operation of seeking for reference point switch in the reverse direction, C pulse is not required)</td></tr> <tr><td colspan="2">Reserved</td></tr> <tr><td colspan="2">Reserved</td></tr> <tr><td colspan="2">Enable back zero switch when powering on</td></tr> <tr><td>0</td><td>Do not switch on back zero when powering on</td></tr> <tr><td>1</td><td>Switch on back zero automatically after the first SON when powering on</td></tr> </tbody> </table>						Zero returning method setting		0	DS402 METHOD 35 (set current position as zero point)	1	DS402 METHOD 1 (for on-off operation of seeking for NOT switch in the reverse direction, C pulse is required)	2	DS402 METHOD 2 (for on-off operation of seeking for POT switch in the forward direction, C pulse is required)	3	DS402 METHOD 3 (for on-off operation of seeking for reference point switch in the forward direction, C pulse is required)	4	DS402 METHOD 4 (for on-off operation of seeking for reference point switch in the forward direction, C pulse is required)	5	DS402 METHOD 5 (for on-off operation of seeking for reference point switch in the reverse direction, C pulse is required)	6	DS402 METHOD 6 (for on-off operation of seeking for reference point switch in the reverse direction, C pulse is required)	7	DS402 METHOD 17 (for on-off operation of seeking for NOT switch in the reverse direction, C pulse is not required)	8	DS402 METHOD 18 (for on-off operation of seeking for POT switch in the forward direction, C pulse is not required)	9	DS402 METHOD 19 (for on-off operation of seeking for reference point switch in the forward direction, C pulse is not required)	10	DS402 METHOD 20 (for on-off operation of seeking for reference point switch in the forward direction, C pulse is not required)	11	DS402 METHOD 21 (for on-off operation of seeking for reference point switch in the reverse direction, C pulse is not required)	12	DS402 METHOD 22 (for on-off operation of seeking for reference point switch in the reverse direction, C pulse is not required)	Reserved		Reserved		Enable back zero switch when powering on		0	Do not switch on back zero when powering on	1	Switch on back zero automatically after the first SON when powering on
Zero returning method setting																																												
0	DS402 METHOD 35 (set current position as zero point)																																											
1	DS402 METHOD 1 (for on-off operation of seeking for NOT switch in the reverse direction, C pulse is required)																																											
2	DS402 METHOD 2 (for on-off operation of seeking for POT switch in the forward direction, C pulse is required)																																											
3	DS402 METHOD 3 (for on-off operation of seeking for reference point switch in the forward direction, C pulse is required)																																											
4	DS402 METHOD 4 (for on-off operation of seeking for reference point switch in the forward direction, C pulse is required)																																											
5	DS402 METHOD 5 (for on-off operation of seeking for reference point switch in the reverse direction, C pulse is required)																																											
6	DS402 METHOD 6 (for on-off operation of seeking for reference point switch in the reverse direction, C pulse is required)																																											
7	DS402 METHOD 17 (for on-off operation of seeking for NOT switch in the reverse direction, C pulse is not required)																																											
8	DS402 METHOD 18 (for on-off operation of seeking for POT switch in the forward direction, C pulse is not required)																																											
9	DS402 METHOD 19 (for on-off operation of seeking for reference point switch in the forward direction, C pulse is not required)																																											
10	DS402 METHOD 20 (for on-off operation of seeking for reference point switch in the forward direction, C pulse is not required)																																											
11	DS402 METHOD 21 (for on-off operation of seeking for reference point switch in the reverse direction, C pulse is not required)																																											
12	DS402 METHOD 22 (for on-off operation of seeking for reference point switch in the reverse direction, C pulse is not required)																																											
Reserved																																												
Reserved																																												
Enable back zero switch when powering on																																												
0	Do not switch on back zero when powering on																																											
1	Switch on back zero automatically after the first SON when powering on																																											
P□771	On-off speed to meet reference point	0 ~ 6000	rpm	100	Y																																							
P□772	On-off speed to leave reference	0 ~ 6000	rpm	30	Y																																							

Parameter No.	Name	Setting range	Setting unit	Factory setting	Power reboot	Remarks
	point					
P□773	Low byte of speed/position switching reference point	0 ~ 9999	1-reference pulse	0	N	
P□774	High byte of speed/position switching reference point	0 ~ 9999	10000-reference pulse	0	N	

Appendix B Table of iK Series M2 Drive Parameters

Parameter No.	Name	Setting range	Setting unit	Factory setting	Power reboot	Remarks																																								
P□000	Basic function selection switch	—	—	0010	Y																																									
	<p>Rotation direction selection</p> <table border="1"> <tr> <td>0</td> <td>CCW (counter clockwise) is the positive rotation direction</td> </tr> <tr> <td>1</td> <td>CW (clockwise) is the positive rotation direction (in reserve mode)</td> </tr> </table> <p>Control mode selection</p> <table border="1"> <tr> <td>0</td> <td>Speed control (analog reference)</td> </tr> <tr> <td>1</td> <td>Position control (pulse train reference)</td> </tr> <tr> <td>2</td> <td>Torque control (analog reference)</td> </tr> <tr> <td>3</td> <td>Internal set speed control (contact reference)</td> </tr> <tr> <td>4</td> <td>Internal set speed control (contact reference) ↔ Speed control (analog reference)</td> </tr> <tr> <td>5</td> <td>Internal set speed control (contact reference) ↔ Position control (pulse train reference)</td> </tr> <tr> <td>6</td> <td>Internal set speed control (contact reference) ↔ Torque control (analog reference)</td> </tr> <tr> <td>7</td> <td>Position control (pulse train reference) ↔ Speed control (analog reference)</td> </tr> <tr> <td>8</td> <td>Position control (pulse train reference) ↔ Speed control (analog reference)</td> </tr> <tr> <td>9</td> <td>Torque control (analog reference) ↔ Speed control (analog reference)</td> </tr> <tr> <td>A</td> <td>Speed control (analog reference) ↔ Zero clamping</td> </tr> <tr> <td>B</td> <td>Position control (pulse train reference) ↔ Position control (pulse prohibited)</td> </tr> <tr> <td>C</td> <td>Internal position control</td> </tr> </table> <p>Stop method when servo is OFF</p> <table border="1"> <tr> <td>0</td> <td>Reverse braking the motor decelerates to a stop, then Set it to free-running status</td> </tr> <tr> <td>1</td> <td>Set motor to inertial operation state</td> </tr> </table> <p>Stop method during overtravel (OT)</p> <table border="1"> <tr> <td>0</td> <td>Reverse braking the motor decelerates to a stop, then Set it to free-running status</td> </tr> <tr> <td>1</td> <td>Reverse braking the motor decelerates to a stop, then Set it to free-running status</td> </tr> <tr> <td>2</td> <td>Set motor to inertial operation state</td> </tr> </table>						0	CCW (counter clockwise) is the positive rotation direction	1	CW (clockwise) is the positive rotation direction (in reserve mode)	0	Speed control (analog reference)	1	Position control (pulse train reference)	2	Torque control (analog reference)	3	Internal set speed control (contact reference)	4	Internal set speed control (contact reference) ↔ Speed control (analog reference)	5	Internal set speed control (contact reference) ↔ Position control (pulse train reference)	6	Internal set speed control (contact reference) ↔ Torque control (analog reference)	7	Position control (pulse train reference) ↔ Speed control (analog reference)	8	Position control (pulse train reference) ↔ Speed control (analog reference)	9	Torque control (analog reference) ↔ Speed control (analog reference)	A	Speed control (analog reference) ↔ Zero clamping	B	Position control (pulse train reference) ↔ Position control (pulse prohibited)	C	Internal position control	0	Reverse braking the motor decelerates to a stop, then Set it to free-running status	1	Set motor to inertial operation state	0	Reverse braking the motor decelerates to a stop, then Set it to free-running status	1	Reverse braking the motor decelerates to a stop, then Set it to free-running status	2	Set motor to inertial operation state
0	CCW (counter clockwise) is the positive rotation direction																																													
1	CW (clockwise) is the positive rotation direction (in reserve mode)																																													
0	Speed control (analog reference)																																													
1	Position control (pulse train reference)																																													
2	Torque control (analog reference)																																													
3	Internal set speed control (contact reference)																																													
4	Internal set speed control (contact reference) ↔ Speed control (analog reference)																																													
5	Internal set speed control (contact reference) ↔ Position control (pulse train reference)																																													
6	Internal set speed control (contact reference) ↔ Torque control (analog reference)																																													
7	Position control (pulse train reference) ↔ Speed control (analog reference)																																													
8	Position control (pulse train reference) ↔ Speed control (analog reference)																																													
9	Torque control (analog reference) ↔ Speed control (analog reference)																																													
A	Speed control (analog reference) ↔ Zero clamping																																													
B	Position control (pulse train reference) ↔ Position control (pulse prohibited)																																													
C	Internal position control																																													
0	Reverse braking the motor decelerates to a stop, then Set it to free-running status																																													
1	Set motor to inertial operation state																																													
0	Reverse braking the motor decelerates to a stop, then Set it to free-running status																																													
1	Reverse braking the motor decelerates to a stop, then Set it to free-running status																																													
2	Set motor to inertial operation state																																													
P□001	Basic function selection switch 1	—	—	0001	Y																																									

Parameter No.	Name	Setting range	Setting unit	Factory setting	Power reboot	Remarks																														
	<p>H <input type="checkbox"/> Bit 3 <input type="checkbox"/> Bit 2 <input type="checkbox"/> Bit 1 <input type="checkbox"/> Bit 0</p> <table border="1"> <tr><th colspan="2">Use method of encoder</th></tr> <tr><td>0</td><td>Use absolute encoder as absolute encoder and enable serial output of absolute data (PG frequency dividing PAO□)</td></tr> <tr><td>1</td><td>Use absolute encoder as incremental encoder</td></tr> <tr><td>2</td><td>Use absolute encoder as absolute encoder and disable serial output of absolute data</td></tr> </table> <table border="1"> <tr><th colspan="2">Speed control option (T-REF distribution)</th></tr> <tr><td>0</td><td>N A</td></tr> <tr><td>1</td><td>Use T-REF as external torque limit input</td></tr> <tr><td>2</td><td>Use T-REF as torque feedforward input</td></tr> <tr><td>3</td><td>Use T-REF as external torque limit input when P-CL and N-CL are enabled</td></tr> </table> <table border="1"> <tr><th colspan="2">Torque control option (V-REF distribution)</th></tr> <tr><td>0</td><td>N A</td></tr> <tr><td>1</td><td>Use V-REF as external torque limit input</td></tr> </table> <table border="1"> <tr><th colspan="2">Accelerated speed feedforward mode selection</th></tr> <tr><td>0</td><td>Accelerated speed feedforward type 1 (filtering calculation)</td></tr> <tr><td>1</td><td>Accelerated speed feedforward type 2 (rapid calculation)</td></tr> </table>	Use method of encoder		0	Use absolute encoder as absolute encoder and enable serial output of absolute data (PG frequency dividing PAO□)	1	Use absolute encoder as incremental encoder	2	Use absolute encoder as absolute encoder and disable serial output of absolute data	Speed control option (T-REF distribution)		0	N A	1	Use T-REF as external torque limit input	2	Use T-REF as torque feedforward input	3	Use T-REF as external torque limit input when P-CL and N-CL are enabled	Torque control option (V-REF distribution)		0	N A	1	Use V-REF as external torque limit input	Accelerated speed feedforward mode selection		0	Accelerated speed feedforward type 1 (filtering calculation)	1	Accelerated speed feedforward type 2 (rapid calculation)					
Use method of encoder																																				
0	Use absolute encoder as absolute encoder and enable serial output of absolute data (PG frequency dividing PAO□)																																			
1	Use absolute encoder as incremental encoder																																			
2	Use absolute encoder as absolute encoder and disable serial output of absolute data																																			
Speed control option (T-REF distribution)																																				
0	N A																																			
1	Use T-REF as external torque limit input																																			
2	Use T-REF as torque feedforward input																																			
3	Use T-REF as external torque limit input when P-CL and N-CL are enabled																																			
Torque control option (V-REF distribution)																																				
0	N A																																			
1	Use V-REF as external torque limit input																																			
Accelerated speed feedforward mode selection																																				
0	Accelerated speed feedforward type 1 (filtering calculation)																																			
1	Accelerated speed feedforward type 2 (rapid calculation)																																			
P□002	Basic function selection switch 2	—	—	1100	Y																															
	<p>H <input type="checkbox"/> Bit 3 <input type="checkbox"/> Bit 2 <input type="checkbox"/> Bit 1 <input type="checkbox"/> Bit 0</p> <table border="1"> <tr><th colspan="2">Second electronic gear enabled</th></tr> <tr><td>0</td><td>Disable second electronic gear and use /P-CON signal as P/PI switch</td></tr> <tr><td>1</td><td>Enable second electronic gear and use /P-CON signal as second electronic gear switch</td></tr> </table> <table border="1"> <tr><th colspan="2">Preset constant (do not change)</th></tr> <tr><td>0</td><td>Reserved</td></tr> <tr><td>1</td><td>Reserved</td></tr> </table> <table border="1"> <tr><th colspan="2">Preset constant (do not change)</th></tr> <tr><td>0</td><td>Reserved</td></tr> <tr><td>1</td><td>Reserved</td></tr> </table> <table border="1"> <tr><th colspan="2">Preset constant (do not change)</th></tr> <tr><td>0</td><td>Reserved</td></tr> <tr><td>1</td><td>Reserved</td></tr> </table>	Second electronic gear enabled		0	Disable second electronic gear and use /P-CON signal as P/PI switch	1	Enable second electronic gear and use /P-CON signal as second electronic gear switch	Preset constant (do not change)		0	Reserved	1	Reserved	Preset constant (do not change)		0	Reserved	1	Reserved	Preset constant (do not change)		0	Reserved	1	Reserved											
Second electronic gear enabled																																				
0	Disable second electronic gear and use /P-CON signal as P/PI switch																																			
1	Enable second electronic gear and use /P-CON signal as second electronic gear switch																																			
Preset constant (do not change)																																				
0	Reserved																																			
1	Reserved																																			
Preset constant (do not change)																																				
0	Reserved																																			
1	Reserved																																			
Preset constant (do not change)																																				
0	Reserved																																			
1	Reserved																																			
P□003	Basic function selection switch 3	—	—	0000	Y																															

Parameter No.	Name	Setting range	Setting unit	Factory setting	Power reboot	Remarks
		Common encoder (non-serial encoder) alarm enable switch		0	Disable A05 - A08 or b05 - b08 alarm detection	
				1	Enable A05 - A08 or b05 - b08 alarm detection	
		Preset constant (do not change)		0	Reserved	
				1	Reserved	
		Momentary outage alarm enable switch		0	No alarm for momentary outage of one cycle	
				1	Alarm for momentary outage of one cycle	
		Overload enhancement enable switch		0	Disable overload enhancement function	
				1	Enable overload enhancement function (enhance overload capacity, suitable for occasion with frequent start and stop)	
P□004	Basic function selection switch 4	—	—	0100	Y	
		Preset constant (do not change)		0	Reserved	
				1	Reserved	
		Preset constant (do not change)		0	Reserved	
		Low-frequency jitter suppression enable switch		0	Disable low-frequency jitter suppression	
				1	Enable low-frequency jitter suppression	
		Out-of-tolerance alarm detection		0	Disable out-of-tolerance alarm detection	
				1	Enable out-of-tolerance alarm detection (alarm will be given when offset counter value exceeds P□504)	
P□100	Speed loop gain	1 ~ 2500	0.1 Hz	400	N	
P□101	Speed loop integral time constant	1 ~ 4000	0.01 ms	2000	N	
P□102	Position loop gain	1 ~ 2000	0.1/s	400	N	
P□103	Ratio of moment of inertia	0 ~ 20000	1 %	0	N	
P□104	Second speed loop gain	1 ~ 2500	1 Hz	40	N	
P□105	Second speed loop integral time constant	1 ~ 4000	0.1ms	200	N	
P□106	Second position loop gain	1 ~ 2000	1/s	40	N	
P□107	Offset (speed offset)	0 ~ 450	1r/min	0	N	
P□108	Scope of offset stack	0 ~ 5000	1-reference pulse	10	N	
P□109	Feedforward	0 ~ 100	1 %	0	N	
P□110	Feedforward filter time constant	0 ~ 640	0.1ms	0	N	
P□111	Accelerated speed freeforward	0 ~ 100	1 %	0	N	

Parameter No.	Name	Setting range	Setting unit	Factory setting	Power reboot	Remarks																								
	percentage																													
P□112	Accelerated speed feedforward filter time constant	0 ~ 640	0.1ms	0	N																									
P□113	Gain application switch	0000 ~ 0064	—	0000	Y																									
	<p>Module switch selection</p> <table border="1"> <tr><td>0</td><td>Use internal torque reference as the condition (level setting: P□114)</td></tr> <tr><td>1</td><td>Use speed as the condition (level setting: P□115)</td></tr> <tr><td>2</td><td>Use acceleration as the condition (level setting: P□116)</td></tr> <tr><td>3</td><td>Use position error pulse as the condition (level setting: P□117)</td></tr> <tr><td>4</td><td>No mode switch function</td></tr> </table> <p>Selection of auto gain switch conditions</p> <table border="1"> <tr><td>0</td><td>Non-auto gain switch (fixed to first group gain)</td></tr> <tr><td>1</td><td>External switch gain switch (G-SEL signal)</td></tr> <tr><td>2</td><td>Torque percentage switch</td></tr> <tr><td>3</td><td>Switch only under position offset</td></tr> <tr><td>4</td><td>Given accelerated speed value (10 r/min/s)</td></tr> <tr><td>5</td><td>Given speed value</td></tr> <tr><td>6</td><td>With position reference input</td></tr> </table> <p>Reserved</p> <p>Reserved</p>						0	Use internal torque reference as the condition (level setting: P□114)	1	Use speed as the condition (level setting: P□115)	2	Use acceleration as the condition (level setting: P□116)	3	Use position error pulse as the condition (level setting: P□117)	4	No mode switch function	0	Non-auto gain switch (fixed to first group gain)	1	External switch gain switch (G-SEL signal)	2	Torque percentage switch	3	Switch only under position offset	4	Given accelerated speed value (10 r/min/s)	5	Given speed value	6	With position reference input
0	Use internal torque reference as the condition (level setting: P□114)																													
1	Use speed as the condition (level setting: P□115)																													
2	Use acceleration as the condition (level setting: P□116)																													
3	Use position error pulse as the condition (level setting: P□117)																													
4	No mode switch function																													
0	Non-auto gain switch (fixed to first group gain)																													
1	External switch gain switch (G-SEL signal)																													
2	Torque percentage switch																													
3	Switch only under position offset																													
4	Given accelerated speed value (10 r/min/s)																													
5	Given speed value																													
6	With position reference input																													
P□114	Mode switch (torque reference)	0 ~ 300	1 %	200	N																									
P□115	Mode switch (speed reference)	0 ~ 10000	1r/min	0	N																									
P□116	Mode switch (accelerated speed reference)	0 ~ 3000	10 r/min/s	0	N																									
P□117	Mode switch (offset pulse)	0 ~ 10000	1-reference pulse	0	N																									
P□118	Gain switch delay time	0 ~ 20000	0.1 ms (single axis)	0	N	0.2 ms (double axis)																								
P□119	Gain switch range	0 ~ 20000	free	0	N																									
	When P□113.1 = 2, the unit is 1% When P□113.1 = 3, the unit is 1 reference pulse When P□113.1 = 4, the unit is 10 r/min/s When P□113.1 = 5, the unit is 1 r/min When P□113.1 = 6, the unit is 1 reference pulse																													
P□120	Position gain switch time	0 ~ 20000	0.1 ms (single axis)	0	N	0.2 ms (double axis)																								
P□121	Gain switch hysteresis	0 ~ 20000	1-reference pulse	0	N																									
P□122	Friction load	0 ~ 3000	1%	0	N																									
P□123	Friction compensation speed hysteresis area	0 ~ 100	1r/min	0	Y																									
P□124	Viscous friction load	0 ~ 20000	1 %/1 krpm	0	N																									

Parameter No.	Name	Setting range	Setting unit	Factory setting	Power reboot	Remarks																																															
P□125	Friction gain	0 ~ 30000		0	N																																																
P□126	Speed observer cycle	0 ~ 100	0.1ms	0/35/70	N																																																
P□127	Online autotune switches	—	—	1340	Y/N																																																
<div style="display: flex; align-items: center;"> <div style="margin-right: 10px;"> H </div> <div style="display: flex; gap: 10px;"> <div style="text-align: center;">Bit 3 <input type="checkbox"/></div> <div style="text-align: center;">Bit 2 <input type="checkbox"/></div> <div style="text-align: center;">Bit 1 <input type="checkbox"/></div> <div style="text-align: center;">Bit 0 <input type="checkbox"/></div> </div> </div> <table border="1" style="width: 100%; border-collapse: collapse;"> <thead> <tr style="background-color: black; color: white;"> <th colspan="2">Real-time auto gain setting</th> <th>Power reboot</th> </tr> </thead> <tbody> <tr> <td style="text-align: center;">0</td> <td>Non-real-time auto gain adjustment</td> <td rowspan="7" style="text-align: center; vertical-align: middle;">Y</td> </tr> <tr> <td style="text-align: center;">1</td> <td>Normal mode (suitable for operations without change in load inertia)</td> </tr> <tr> <td style="text-align: center;">2</td> <td>Normal mode (suitable for operations with little change in load inertia)</td> </tr> <tr> <td style="text-align: center;">3</td> <td>Normal mode (suitable for operations with great change in load inertia)</td> </tr> <tr> <td style="text-align: center;">4</td> <td>Vertical load (suitable for operations without change in load inertia)</td> </tr> <tr> <td style="text-align: center;">5</td> <td>Vertical load (suitable for operations with little change in load inertia)</td> </tr> <tr> <td style="text-align: center;">6</td> <td>Vertical load (suitable for operations with great change in load inertia)</td> </tr> <tr style="background-color: black; color: white;"> <th colspan="2">Selection of machine stiffness for real-time auto gain</th> <th>Power reboot</th> </tr> <tr> <td style="text-align: center;">0</td> <td rowspan="3">Machine stiffness during real-time auto gain adjustment may be selected. The larger the parameter value is, the quicker the response will be. If this parameter is set very high all at once, system gain will change significantly, leading to great shock to machine. It is recommended to set a small value and gradually select larger stiffness while monitoring operating status of machine.</td> <td rowspan="3" style="text-align: center; vertical-align: middle;">N</td> </tr> <tr> <td style="text-align: center;">...</td> </tr> <tr> <td style="text-align: center;">F</td> </tr> <tr style="background-color: black; color: white;"> <th colspan="3">Reserved</th> </tr> <tr style="background-color: black; color: white;"> <th colspan="2">Normal auto adjustment mode setting</th> <th>Power reboot</th> </tr> <tr> <td style="text-align: center;">0</td> <td>Rotating circles: 1; direction: CCW → CW</td> <td rowspan="8" style="text-align: center; vertical-align: middle;">N</td> </tr> <tr> <td style="text-align: center;">1</td> <td>Rotating circles: 2; direction: CCW → CW</td> </tr> <tr> <td style="text-align: center;">2</td> <td>Rotating circles: 3; direction: CCW → CW</td> </tr> <tr> <td style="text-align: center;">3</td> <td>Rotating circles: 4; direction: CCW → CW</td> </tr> <tr> <td style="text-align: center;">4</td> <td>Rotating circles: 1; direction: CW → CCW</td> </tr> <tr> <td style="text-align: center;">5</td> <td>Rotating circles: 2; direction: CW → CCW</td> </tr> <tr> <td style="text-align: center;">6</td> <td>Rotating circles: 3; direction: CW → CCW</td> </tr> <tr> <td style="text-align: center;">7</td> <td>Rotating circles: 4; direction: CW → CCW</td> </tr> </tbody> </table>	Real-time auto gain setting		Power reboot	0	Non-real-time auto gain adjustment	Y	1	Normal mode (suitable for operations without change in load inertia)	2	Normal mode (suitable for operations with little change in load inertia)	3	Normal mode (suitable for operations with great change in load inertia)	4	Vertical load (suitable for operations without change in load inertia)	5	Vertical load (suitable for operations with little change in load inertia)	6	Vertical load (suitable for operations with great change in load inertia)	Selection of machine stiffness for real-time auto gain		Power reboot	0	Machine stiffness during real-time auto gain adjustment may be selected. The larger the parameter value is, the quicker the response will be. If this parameter is set very high all at once, system gain will change significantly, leading to great shock to machine. It is recommended to set a small value and gradually select larger stiffness while monitoring operating status of machine.	N	...	F	Reserved			Normal auto adjustment mode setting		Power reboot	0	Rotating circles: 1; direction: CCW → CW	N	1	Rotating circles: 2; direction: CCW → CW	2	Rotating circles: 3; direction: CCW → CW	3	Rotating circles: 4; direction: CCW → CW	4	Rotating circles: 1; direction: CW → CCW	5	Rotating circles: 2; direction: CW → CCW	6	Rotating circles: 3; direction: CW → CCW	7	Rotating circles: 4; direction: CW → CCW				
	Real-time auto gain setting		Power reboot																																																		
	0	Non-real-time auto gain adjustment	Y																																																		
	1	Normal mode (suitable for operations without change in load inertia)																																																			
	2	Normal mode (suitable for operations with little change in load inertia)																																																			
	3	Normal mode (suitable for operations with great change in load inertia)																																																			
	4	Vertical load (suitable for operations without change in load inertia)																																																			
	5	Vertical load (suitable for operations with little change in load inertia)																																																			
	6	Vertical load (suitable for operations with great change in load inertia)																																																			
	Selection of machine stiffness for real-time auto gain		Power reboot																																																		
0	Machine stiffness during real-time auto gain adjustment may be selected. The larger the parameter value is, the quicker the response will be. If this parameter is set very high all at once, system gain will change significantly, leading to great shock to machine. It is recommended to set a small value and gradually select larger stiffness while monitoring operating status of machine.	N																																																			
...																																																					
F																																																					
Reserved																																																					
Normal auto adjustment mode setting		Power reboot																																																			
0	Rotating circles: 1; direction: CCW → CW	N																																																			
1	Rotating circles: 2; direction: CCW → CW																																																				
2	Rotating circles: 3; direction: CCW → CW																																																				
3	Rotating circles: 4; direction: CCW → CW																																																				
4	Rotating circles: 1; direction: CW → CCW																																																				
5	Rotating circles: 2; direction: CW → CCW																																																				
6	Rotating circles: 3; direction: CW → CCW																																																				
7	Rotating circles: 4; direction: CW → CCW																																																				
P□200	Position control reference form selection switch	—	—	0000	Y																																																

Parameter No.	Name	Setting range	Setting unit	Factory setting	Power reboot	Remarks																																				
						<table border="1"> <thead> <tr> <th colspan="2">Offset pulse clearing method</th> </tr> </thead> <tbody> <tr> <td>0</td> <td>Clear error pulse(servo OFF); Does not clear error pulse(over travel)</td> </tr> <tr> <td>1</td> <td>Does not clear offset pulse(servo OFF or over travel)</td> </tr> <tr> <td>2</td> <td>Clear offset pulse (servo OFF or over travel ,except for zero clamping position)</td> </tr> </tbody> </table> <table border="1"> <thead> <tr> <th colspan="2">Reference pulse form</th> </tr> </thead> <tbody> <tr> <td>0</td> <td>Sign + pulse</td> </tr> <tr> <td>1</td> <td>CW+CCW</td> </tr> <tr> <td>2</td> <td>A phase + B phase (1x frequency)</td> </tr> <tr> <td>3</td> <td>A phase + B phase (2x frequency)</td> </tr> <tr> <td>4</td> <td>A phase + B phase (4x frequency)</td> </tr> </tbody> </table> <table border="1"> <thead> <tr> <th colspan="2">Reverse setting of reference pulse signal</th> </tr> </thead> <tbody> <tr> <td>0</td> <td>Does not reverse PULS and SIGN</td> </tr> <tr> <td>1</td> <td>Does not reverse PULS, reverse SIGN</td> </tr> <tr> <td>2</td> <td>Reverse PULS , does not reverse SIGN</td> </tr> <tr> <td>3</td> <td>Reverse PULS and SIGN</td> </tr> </tbody> </table> <table border="1"> <thead> <tr> <th colspan="2">Filter selection</th> </tr> </thead> <tbody> <tr> <td>0</td> <td>Bus driver signal reference input filter</td> </tr> <tr> <td>1</td> <td>Collector open-circuit signal reference input filter</td> </tr> </tbody> </table>	Offset pulse clearing method		0	Clear error pulse(servo OFF); Does not clear error pulse(over travel)	1	Does not clear offset pulse(servo OFF or over travel)	2	Clear offset pulse (servo OFF or over travel ,except for zero clamping position)	Reference pulse form		0	Sign + pulse	1	CW+CCW	2	A phase + B phase (1x frequency)	3	A phase + B phase (2x frequency)	4	A phase + B phase (4x frequency)	Reverse setting of reference pulse signal		0	Does not reverse PULS and SIGN	1	Does not reverse PULS, reverse SIGN	2	Reverse PULS , does not reverse SIGN	3	Reverse PULS and SIGN	Filter selection		0	Bus driver signal reference input filter	1	Collector open-circuit signal reference input filter
Offset pulse clearing method																																										
0	Clear error pulse(servo OFF); Does not clear error pulse(over travel)																																									
1	Does not clear offset pulse(servo OFF or over travel)																																									
2	Clear offset pulse (servo OFF or over travel ,except for zero clamping position)																																									
Reference pulse form																																										
0	Sign + pulse																																									
1	CW+CCW																																									
2	A phase + B phase (1x frequency)																																									
3	A phase + B phase (2x frequency)																																									
4	A phase + B phase (4x frequency)																																									
Reverse setting of reference pulse signal																																										
0	Does not reverse PULS and SIGN																																									
1	Does not reverse PULS, reverse SIGN																																									
2	Reverse PULS , does not reverse SIGN																																									
3	Reverse PULS and SIGN																																									
Filter selection																																										
0	Bus driver signal reference input filter																																									
1	Collector open-circuit signal reference input filter																																									
P□201	PG frequency dividing	16 ~ 32768	1 P/rev	2500	Y																																					
P□202	First electronic gear ratio (numerator)	1 ~ 65535	—	1	Y																																					
P□203	First electronic gear ratio (denominator)	1 ~ 65535	—	1	Y																																					
P□204	Second electronic gear ratio (numerator)	1 ~ 65535	—	1	Y																																					
P□205	Position reference acceleration/deceleration time parameter	0 ~ 6400	0.1ms	0	N																																					
P□206	Position reference filter form selection	0 ~ 1	—	0	Y																																					
P□300	Speed reference input gain	0 ~ 3000	(r/min)/V	150	N																																					
P□301	Internal speed 1	0 ~ 6000	1r/min	100	N																																					
P□302	Internal speed 2	0 ~ 6000	1r/min	200	N																																					
P□303	Internal speed 3	0 ~ 6000	1r/min	300	N																																					
P□304	Jogging (JOG) speed	0 ~ 6000	1r/min	500	N																																					
P□305	Acceleration time of soft start	0 ~ 10000	1 ms	0	N																																					
P□306	Deceleration time of soft start	0 ~ 10000	1 ms	0	N																																					
P□307	Speed reference filter constant	0 ~ 10000	1 ms	0	N																																					
P□308	Rise time of S curve	0 ~ 10000	1 ms	0	N																																					
P□309	Speed reference curve form	—	—	0000	Y																																					

Parameter No.	Name	Setting range	Setting unit	Factory setting	Power reboot	Remarks																												
						<table border="1"> <thead> <tr> <th colspan="2">Soft start method</th> </tr> </thead> <tbody> <tr> <td>0</td> <td>Trapezoid</td> </tr> <tr> <td>1</td> <td>S curve</td> </tr> <tr> <td>2</td> <td>Acceleration and deceleration filter</td> </tr> </tbody> </table> <table border="1"> <thead> <tr> <th colspan="2">Acceleration and deceleration filter form</th> </tr> </thead> <tbody> <tr> <td>0</td> <td>First filter</td> </tr> <tr> <td>1</td> <td>Second filter</td> </tr> </tbody> </table> <table border="1"> <thead> <tr> <th colspan="2">Selection of S curve ratio</th> </tr> </thead> <tbody> <tr> <td>0</td> <td>Close to linearity</td> </tr> <tr> <td>1</td> <td>Low</td> </tr> <tr> <td>2</td> <td>Medium</td> </tr> <tr> <td>3</td> <td>High</td> </tr> </tbody> </table> <table border="1"> <thead> <tr> <th colspan="2">Reserved</th> </tr> </thead> <tbody> <tr> <td></td> <td></td> </tr> </tbody> </table>	Soft start method		0	Trapezoid	1	S curve	2	Acceleration and deceleration filter	Acceleration and deceleration filter form		0	First filter	1	Second filter	Selection of S curve ratio		0	Close to linearity	1	Low	2	Medium	3	High	Reserved			
Soft start method																																		
0	Trapezoid																																	
1	S curve																																	
2	Acceleration and deceleration filter																																	
Acceleration and deceleration filter form																																		
0	First filter																																	
1	Second filter																																	
Selection of S curve ratio																																		
0	Close to linearity																																	
1	Low																																	
2	Medium																																	
3	High																																	
Reserved																																		
P□400	Torque reference input gain	10 ~ 100	0.1V/rated torque	30	N																													
P□401	Torque reference filter time constant	0 ~ 250	0.1ms	4	N																													
P□402	Second torque reference filter time constant	0 ~ 250	0.1ms	4	N																													
P□403	Forward torque limit	0 ~ 300	1 %	300	N																													
P□404	Reverse torque limit	0 ~ 300	1 %	300	N																													
P□405	Forward external torque limit	0 ~ 300	1 %	100	N																													
P□406	Reverse external torque limit	0 ~ 300	1 %	100	N																													
P□407	Plug braking torque limit	0 ~ 300	1 %	300	N																													
P□408	Speed limit during torque control	0 ~ 6000	1r/min	1500	N																													
P□409	Frequency of notch filter section 1	50 ~ 5000	1 Hz	5000	N																													
P□410	Depth of notch filter section 1	0 ~ 100	—	10	N																													
P□411	Frequency of notch filter section 2	50 ~ 5000	1 Hz	5000	N																													
P□412	Depth of notch filter section 2	0 ~ 100	—	10	N																													
P□413	B type vibration frequency	10 ~ 1000	0.1 Hz	1000	N																													
P□414	B type vibration damping	0 ~ 200	—	25	N																													
P□500	Positioning completion width	0 ~ 5000	1 reference unit	10	N																													
P□501	Zero clamping level	0 ~ 3000	1r/min	10	N																													
P□502	Rotation detection of electric level	0 ~ 3000	1r/min	20	N																													
P□503	Same-speed signal detection width	0 ~ 100	1r/min	10	N																													
P□504	Offset pulse overflow level	1 ~ 32767	256 reference unit	1024	N																													
P□505	Latency time for servo to turn on	0 ~ 2000	ms	0	N																													
P□506	Waiting time of servo ON	0 ~ 500	10ms	0	N																													
P□507	Brake command - delay time of servo OFF	0 ~ 6000	1r/min	100	N																													

Parameter No.	Name	Setting range	Setting unit	Factory setting	Power reboot	Remarks
P□508	Brake command wait time when servo is OFF	10 ~ 100	10ms	50	N	

Parameter No.	Name	Setting range	Setting unit	Factory setting	Power reboot	Remarks																																																																						
P□509	Input signal selection 1	—	—	4321	Y	8765 (double axis/b)																																																																						
<div style="display: flex; align-items: flex-start;"> <div style="margin-right: 20px;"> <p>H</p> <div style="display: flex; justify-content: space-around; width: 100px;"> <div style="text-align: center;">Bit 3 <input type="checkbox"/></div> <div style="text-align: center;">Bit 2 <input type="checkbox"/></div> <div style="text-align: center;">Bit 1 <input type="checkbox"/></div> <div style="text-align: center;">Bit 0 <input type="checkbox"/></div> </div> </div> <div> <table border="1" style="width: 100%; border-collapse: collapse;"> <thead> <tr style="background-color: black; color: white;"> <th colspan="2">/S-ON signal distribution</th> </tr> </thead> <tbody> <tr><td>0</td><td>Set signal fixed to be "inactive"</td></tr> <tr><td>1</td><td>Active when IN1 (CN3-14) input signal is ON</td></tr> <tr><td>2</td><td>Active when IN2 (CN3-15) input signal is ON</td></tr> <tr><td>3</td><td>Active when IN3 (CN3-16) input signal is ON</td></tr> <tr><td>4</td><td>Active when IN4 (CN3-17) input signal is ON</td></tr> <tr><td>5</td><td>Active when IN5 (CN3-39) input signal is ON</td></tr> <tr><td>6</td><td>Active when IN6 (CN3-40) input signal is ON</td></tr> <tr><td>7</td><td>Active when IN7 (CN3-41) input signal is ON</td></tr> <tr><td>8</td><td>Active when IN8 (CN3-42) input signal is ON</td></tr> <tr><td>9</td><td>Set signal fixed to be "active"</td></tr> </tbody> </table> <table border="1" style="width: 100%; border-collapse: collapse;"> <thead> <tr style="background-color: black; color: white;"> <th colspan="2">/P-CON signal distribution (P control when input signal is ON)</th> </tr> </thead> <tbody> <tr><td>0-9</td><td>Ditto</td></tr> </tbody> </table> <table border="1" style="width: 100%; border-collapse: collapse;"> <thead> <tr style="background-color: black; color: white;"> <th colspan="2">P-OT signal distribution (positive rotation drive prohibited when OFF)</th> </tr> </thead> <tbody> <tr><td>0</td><td>Set signal fixed to be "positive rotation drive prohibited"</td></tr> <tr><td>1</td><td>Active when IN1 (CN3-14) input signal is ON</td></tr> <tr><td>2</td><td>Active when IN2 (CN3-15) input signal is ON</td></tr> <tr><td>3</td><td>Active when IN3 (CN3-16) input signal is ON</td></tr> <tr><td>4</td><td>Active when IN4 (CN3-17) input signal is ON</td></tr> <tr><td>5</td><td>Active when IN5 (CN3-39) input signal is ON</td></tr> <tr><td>6</td><td>Active when IN6 (CN3-40) input signal is ON</td></tr> <tr><td>7</td><td>Active when IN7 (CN3-41) input signal is ON</td></tr> <tr><td>8</td><td>Active when IN8 (CN3-42) input signal is ON</td></tr> <tr><td>9</td><td>Set signal fixed to be "positive rotation drive allowed"</td></tr> </tbody> </table> <table border="1" style="width: 100%; border-collapse: collapse;"> <thead> <tr style="background-color: black; color: white;"> <th colspan="2">N-OT signal distribution (negative drive prohibited when input signal is OFF)</th> </tr> </thead> <tbody> <tr><td>0</td><td>Set signal fixed to be "negative rotation side drive prohibited"</td></tr> <tr><td>1</td><td>Active when IN1 (CN3-14) input signal is ON</td></tr> <tr><td>2</td><td>Active when IN2 (CN3-15) input signal is ON</td></tr> <tr><td>3</td><td>Active when IN3 (CN3-16) input signal is ON</td></tr> <tr><td>4</td><td>Active when IN4 (CN3-17) input signal is ON</td></tr> <tr><td>5</td><td>Active when IN5 (CN3-39) input signal is ON</td></tr> <tr><td>6</td><td>Active when IN6 (CN3-40) input signal is ON</td></tr> <tr><td>7</td><td>Active when IN7 (CN3-41) input signal is ON</td></tr> <tr><td>8</td><td>Active when IN8 (CN3-42) input signal is ON</td></tr> <tr><td>9</td><td>Set signal fixed to be "negative rotation side drive allowed"</td></tr> </tbody> </table> </div> </div>							/S-ON signal distribution		0	Set signal fixed to be "inactive"	1	Active when IN1 (CN3-14) input signal is ON	2	Active when IN2 (CN3-15) input signal is ON	3	Active when IN3 (CN3-16) input signal is ON	4	Active when IN4 (CN3-17) input signal is ON	5	Active when IN5 (CN3-39) input signal is ON	6	Active when IN6 (CN3-40) input signal is ON	7	Active when IN7 (CN3-41) input signal is ON	8	Active when IN8 (CN3-42) input signal is ON	9	Set signal fixed to be "active"	/P-CON signal distribution (P control when input signal is ON)		0-9	Ditto	P-OT signal distribution (positive rotation drive prohibited when OFF)		0	Set signal fixed to be "positive rotation drive prohibited"	1	Active when IN1 (CN3-14) input signal is ON	2	Active when IN2 (CN3-15) input signal is ON	3	Active when IN3 (CN3-16) input signal is ON	4	Active when IN4 (CN3-17) input signal is ON	5	Active when IN5 (CN3-39) input signal is ON	6	Active when IN6 (CN3-40) input signal is ON	7	Active when IN7 (CN3-41) input signal is ON	8	Active when IN8 (CN3-42) input signal is ON	9	Set signal fixed to be "positive rotation drive allowed"	N-OT signal distribution (negative drive prohibited when input signal is OFF)		0	Set signal fixed to be "negative rotation side drive prohibited"	1	Active when IN1 (CN3-14) input signal is ON	2	Active when IN2 (CN3-15) input signal is ON	3	Active when IN3 (CN3-16) input signal is ON	4	Active when IN4 (CN3-17) input signal is ON	5	Active when IN5 (CN3-39) input signal is ON	6	Active when IN6 (CN3-40) input signal is ON	7	Active when IN7 (CN3-41) input signal is ON	8	Active when IN8 (CN3-42) input signal is ON	9	Set signal fixed to be "negative rotation side drive allowed"
/S-ON signal distribution																																																																												
0	Set signal fixed to be "inactive"																																																																											
1	Active when IN1 (CN3-14) input signal is ON																																																																											
2	Active when IN2 (CN3-15) input signal is ON																																																																											
3	Active when IN3 (CN3-16) input signal is ON																																																																											
4	Active when IN4 (CN3-17) input signal is ON																																																																											
5	Active when IN5 (CN3-39) input signal is ON																																																																											
6	Active when IN6 (CN3-40) input signal is ON																																																																											
7	Active when IN7 (CN3-41) input signal is ON																																																																											
8	Active when IN8 (CN3-42) input signal is ON																																																																											
9	Set signal fixed to be "active"																																																																											
/P-CON signal distribution (P control when input signal is ON)																																																																												
0-9	Ditto																																																																											
P-OT signal distribution (positive rotation drive prohibited when OFF)																																																																												
0	Set signal fixed to be "positive rotation drive prohibited"																																																																											
1	Active when IN1 (CN3-14) input signal is ON																																																																											
2	Active when IN2 (CN3-15) input signal is ON																																																																											
3	Active when IN3 (CN3-16) input signal is ON																																																																											
4	Active when IN4 (CN3-17) input signal is ON																																																																											
5	Active when IN5 (CN3-39) input signal is ON																																																																											
6	Active when IN6 (CN3-40) input signal is ON																																																																											
7	Active when IN7 (CN3-41) input signal is ON																																																																											
8	Active when IN8 (CN3-42) input signal is ON																																																																											
9	Set signal fixed to be "positive rotation drive allowed"																																																																											
N-OT signal distribution (negative drive prohibited when input signal is OFF)																																																																												
0	Set signal fixed to be "negative rotation side drive prohibited"																																																																											
1	Active when IN1 (CN3-14) input signal is ON																																																																											
2	Active when IN2 (CN3-15) input signal is ON																																																																											
3	Active when IN3 (CN3-16) input signal is ON																																																																											
4	Active when IN4 (CN3-17) input signal is ON																																																																											
5	Active when IN5 (CN3-39) input signal is ON																																																																											
6	Active when IN6 (CN3-40) input signal is ON																																																																											
7	Active when IN7 (CN3-41) input signal is ON																																																																											
8	Active when IN8 (CN3-42) input signal is ON																																																																											
9	Set signal fixed to be "negative rotation side drive allowed"																																																																											

Parameter No.	Name	Setting range	Setting unit	Factory setting	Power reboot	Remarks																																		
P□510	Input signal selection 2	—	—	8765 (single axis)	Y	0000 (double axis)																																		
	<p>H Bit 3 Bit 2 Bit 1 Bit 0</p> <table border="1"> <tr><th colspan="2">/ALM-RST signal distribution (Clear alarm when turning from OFF to ON)</th></tr> <tr><td>0</td><td>Set signal fixed to be "OFF"</td></tr> <tr><td>1</td><td>Active when IN1 (CN3-14) input signal is ON</td></tr> <tr><td>2</td><td>Active when IN2 (CN3-15) input signal is ON</td></tr> <tr><td>3</td><td>Active when IN3 (CN3-16) input signal is ON</td></tr> <tr><td>4</td><td>Active when IN4 (CN3-17) input signal is ON</td></tr> <tr><td>5</td><td>Active when IN5 (CN3-39) input signal is ON</td></tr> <tr><td>6</td><td>Active when IN6 (CN3-40) input signal is ON</td></tr> <tr><td>7</td><td>Active when IN7 (CN3-41) input signal is ON</td></tr> <tr><td>8</td><td>Active when IN8 (CN3-42) input signal is ON</td></tr> <tr><td>9</td><td>Set signal fixed to be "ON"</td></tr> </table> <table border="1"> <tr><th colspan="2">/CLR signal distribution</th></tr> <tr><td>0-9</td><td>Same with /S-ON signal conversion</td></tr> </table> <table border="1"> <tr><th colspan="2">/P-CL signal distribution</th></tr> <tr><td>0-9</td><td>Ditto</td></tr> </table> <table border="1"> <tr><th colspan="2">/N-CL signal distribution</th></tr> <tr><td>0-9</td><td>Ditto</td></tr> </table>						/ALM-RST signal distribution (Clear alarm when turning from OFF to ON)		0	Set signal fixed to be "OFF"	1	Active when IN1 (CN3-14) input signal is ON	2	Active when IN2 (CN3-15) input signal is ON	3	Active when IN3 (CN3-16) input signal is ON	4	Active when IN4 (CN3-17) input signal is ON	5	Active when IN5 (CN3-39) input signal is ON	6	Active when IN6 (CN3-40) input signal is ON	7	Active when IN7 (CN3-41) input signal is ON	8	Active when IN8 (CN3-42) input signal is ON	9	Set signal fixed to be "ON"	/CLR signal distribution		0-9	Same with /S-ON signal conversion	/P-CL signal distribution		0-9	Ditto	/N-CL signal distribution		0-9	Ditto
/ALM-RST signal distribution (Clear alarm when turning from OFF to ON)																																								
0	Set signal fixed to be "OFF"																																							
1	Active when IN1 (CN3-14) input signal is ON																																							
2	Active when IN2 (CN3-15) input signal is ON																																							
3	Active when IN3 (CN3-16) input signal is ON																																							
4	Active when IN4 (CN3-17) input signal is ON																																							
5	Active when IN5 (CN3-39) input signal is ON																																							
6	Active when IN6 (CN3-40) input signal is ON																																							
7	Active when IN7 (CN3-41) input signal is ON																																							
8	Active when IN8 (CN3-42) input signal is ON																																							
9	Set signal fixed to be "ON"																																							
/CLR signal distribution																																								
0-9	Same with /S-ON signal conversion																																							
/P-CL signal distribution																																								
0-9	Ditto																																							
/N-CL signal distribution																																								
0-9	Ditto																																							
P□511	Input signal selection 3	—	—	0000	Y																																			
	<p>H Bit 3 Bit 2 Bit 1 Bit 0</p> <table border="1"> <tr><th colspan="2">/G-SEL signal distribution</th></tr> <tr><td>0-9</td><td>Same with /S-ON signal conversion</td></tr> </table> <table border="1"> <tr><th colspan="2">/POS0 signal distribution</th></tr> <tr><td>0-9</td><td>Ditto</td></tr> </table> <table border="1"> <tr><th colspan="2">/POS1 signal distribution</th></tr> <tr><td>0-9</td><td>Ditto</td></tr> </table> <table border="1"> <tr><th colspan="2">/POS2 signal distribution</th></tr> <tr><td>0-9</td><td>Ditto</td></tr> </table>						/G-SEL signal distribution		0-9	Same with /S-ON signal conversion	/POS0 signal distribution		0-9	Ditto	/POS1 signal distribution		0-9	Ditto	/POS2 signal distribution		0-9	Ditto																		
/G-SEL signal distribution																																								
0-9	Same with /S-ON signal conversion																																							
/POS0 signal distribution																																								
0-9	Ditto																																							
/POS1 signal distribution																																								
0-9	Ditto																																							
/POS2 signal distribution																																								
0-9	Ditto																																							
P□512	Input signal selection 4	—	—	0000	Y																																			
	<p>H Bit 3 Bit 2 Bit 1 Bit 0</p> <table border="1"> <tr><th colspan="2">/HOME-REF</th></tr> <tr><td>0-9</td><td>Same with /S-ON signal conversion</td></tr> </table> <table border="1"> <tr><th colspan="2">/POS-START</th></tr> <tr><td>0-9</td><td>Same with /S-ON signal conversion</td></tr> </table> <table border="1"> <tr><th colspan="2">/POS-STEP</th></tr> <tr><td>0-9</td><td>Same with /S-ON signal conversion</td></tr> </table> <table border="1"> <tr><th colspan="2">/POS-START-HOME</th></tr> <tr><td>0-9</td><td>Same with /S-ON signal conversion</td></tr> </table>						/HOME-REF		0-9	Same with /S-ON signal conversion	/POS-START		0-9	Same with /S-ON signal conversion	/POS-STEP		0-9	Same with /S-ON signal conversion	/POS-START-HOME		0-9	Same with /S-ON signal conversion																		
/HOME-REF																																								
0-9	Same with /S-ON signal conversion																																							
/POS-START																																								
0-9	Same with /S-ON signal conversion																																							
/POS-STEP																																								
0-9	Same with /S-ON signal conversion																																							
/POS-START-HOME																																								
0-9	Same with /S-ON signal conversion																																							

Parameter No.	Name	Setting range	Setting unit	Factory setting	Power reboot	Remarks																											
P□513	Output signal selection 1	—	—	4321	Y	0321 (double axis/A) 0654 (double axis/b)																											
	<p>H Bit 3 Bit 2 Bit 1 Bit 0</p> <table border="1"> <thead> <tr> <th colspan="2">Servo alarm signal distribution (ALM)</th> </tr> </thead> <tbody> <tr><td>0</td><td>Inactive (not using the signal)</td></tr> <tr><td>1</td><td>Output such signal via OUT1 (CN3-7 and CN3-8)</td></tr> <tr><td>2</td><td>Output such signal via OUT2 (CN3-9 and CN3-10)</td></tr> <tr><td>3</td><td>Output such signal via OUT3 (CN3-11 and CN3-12)</td></tr> <tr><td>4</td><td>Output such signal via OUT4 (CN3-32 and CN3-33)</td></tr> <tr><td>5</td><td>Output such signal via OUT5 (CN3-34 and CN3-35)</td></tr> <tr><td>6</td><td>Output such signal via OUT6 (CN3-36 and CN3-37)</td></tr> </tbody> </table> <table border="1"> <thead> <tr> <th colspan="2">Positioning completion signal distribution (/COIN)/same-speed detection signal distribution (/V-CMP)</th> </tr> </thead> <tbody> <tr><td>0-6</td><td>Ditto</td></tr> </tbody> </table> <table border="1"> <thead> <tr> <th colspan="2">Motor rotation detection signal distribution (/TGON)</th> </tr> </thead> <tbody> <tr><td>0-6</td><td>Ditto</td></tr> </tbody> </table> <table border="1"> <thead> <tr> <th colspan="2">Servo ready signal distribution (/S-RDY)</th> </tr> </thead> <tbody> <tr><td>0-6</td><td>Ditto</td></tr> </tbody> </table>						Servo alarm signal distribution (ALM)		0	Inactive (not using the signal)	1	Output such signal via OUT1 (CN3-7 and CN3-8)	2	Output such signal via OUT2 (CN3-9 and CN3-10)	3	Output such signal via OUT3 (CN3-11 and CN3-12)	4	Output such signal via OUT4 (CN3-32 and CN3-33)	5	Output such signal via OUT5 (CN3-34 and CN3-35)	6	Output such signal via OUT6 (CN3-36 and CN3-37)	Positioning completion signal distribution (/COIN)/same-speed detection signal distribution (/V-CMP)		0-6	Ditto	Motor rotation detection signal distribution (/TGON)		0-6	Ditto	Servo ready signal distribution (/S-RDY)		0-6
Servo alarm signal distribution (ALM)																																	
0	Inactive (not using the signal)																																
1	Output such signal via OUT1 (CN3-7 and CN3-8)																																
2	Output such signal via OUT2 (CN3-9 and CN3-10)																																
3	Output such signal via OUT3 (CN3-11 and CN3-12)																																
4	Output such signal via OUT4 (CN3-32 and CN3-33)																																
5	Output such signal via OUT5 (CN3-34 and CN3-35)																																
6	Output such signal via OUT6 (CN3-36 and CN3-37)																																
Positioning completion signal distribution (/COIN)/same-speed detection signal distribution (/V-CMP)																																	
0-6	Ditto																																
Motor rotation detection signal distribution (/TGON)																																	
0-6	Ditto																																
Servo ready signal distribution (/S-RDY)																																	
0-6	Ditto																																
P□514	Output signal selection 2	—	—	0065	Y	0000 (double axis)																											
	<p>H Bit 3 Bit 2 Bit 1 Bit 0</p> <table border="1"> <thead> <tr> <th colspan="2">Torque limit output signal distribution (/CLT)</th> </tr> </thead> <tbody> <tr><td>0-6</td><td>Same with ALM signal conversion</td></tr> </tbody> </table> <table border="1"> <thead> <tr> <th colspan="2">Brake signal distribution (/BK)</th> </tr> </thead> <tbody> <tr><td>0-6</td><td>Ditto</td></tr> </tbody> </table> <table border="1"> <thead> <tr> <th colspan="2">Encoder origin signal distribution (/PGC)</th> </tr> </thead> <tbody> <tr><td>0-6</td><td>Ditto</td></tr> </tbody> </table> <table border="1"> <thead> <tr> <th colspan="2">Reserved</th> </tr> </thead> <tbody> <tr><td>0-6</td><td></td></tr> </tbody> </table>						Torque limit output signal distribution (/CLT)		0-6	Same with ALM signal conversion	Brake signal distribution (/BK)		0-6	Ditto	Encoder origin signal distribution (/PGC)		0-6	Ditto	Reserved		0-6												
Torque limit output signal distribution (/CLT)																																	
0-6	Same with ALM signal conversion																																
Brake signal distribution (/BK)																																	
0-6	Ditto																																
Encoder origin signal distribution (/PGC)																																	
0-6	Ditto																																
Reserved																																	
0-6																																	
P□515	Output signal selection 3	—	—	0000	Y																												

Parameter No.	Name	Setting range	Setting unit	Factory setting	Power reboot	Remarks
	<p>H Bit 3 Bit 2 Bit 1 Bit 0</p> <p>Current data set number bit 0 signal distribution when internal position control is in place (/InPosNum0) 0-6 Ditto</p> <p>Current data set number bit 1 signal distribution when internal position control is in place (/InPosNum1) 0-6 Ditto</p> <p>Current data set number bit 2 signal distribution when internal position control is in place (/InPosNum2) 0-6 Ditto</p> <p>Current data set number bit 3 signal distribution when internal position control is in place (/InPosNum3) 0-6 Ditto</p>					
P□516	Reserved	—	—	—	N	
P□517	Input port filter time constant	0 ~ 1000	0.1ms	1	N	
P□518	Alarm input filter time constant	0 ~ 3	0.1ms	1	N	
P□519	Active input port signal level selection 1	—	—	0000	N	
	<p>H Bit 3 Bit 2 Bit 1 Bit 0</p> <p>CN3-14 active input level selection 0 Active when input signal is ON (L level) 1 Active when input signal is OFF (H level)</p> <p>CN3-15 active input level selection 0-1 Ditto</p> <p>CN3-16 active input level selection 0-1 Ditto</p> <p>CN3-17 active input level selection 0-1 Ditto</p>					
P□520	Input port signal logic selection 2	—	—	0000	N	
	<p>H Bit 3 Bit 2 Bit 1 Bit 0</p> <p>CN3-39 active input level selection 0-1 Same with CN3-14 input level selection</p> <p>CN3-40 active input level selection 0-1 Ditto</p> <p>CN3-41 active input level selection 0-1 Ditto</p> <p>CN3-42 active input level selection 0-1 Ditto</p>					
P□521	Output port signal reverse select 1	—	—	0000	N	

Parameter No.	Name	Setting range	Setting unit	Factory setting	Power reboot	Remarks																											
	<p>H Bit 3 Bit 2 Bit 1 Bit 0</p> <p>OUT1 (CN3-7 and CN3-8) output reverse select</p> <table border="1"> <tr><td>0</td><td>Does not inverse</td></tr> <tr><td>1</td><td>Inverse</td></tr> </table> <p>OUT2 (CN3-9 and CN3-10) output reverse select</p> <table border="1"> <tr><td>0-1</td><td>Ditto</td></tr> </table> <p>OUT3 (CN3-11 and CN3-12) output reverse select</p> <table border="1"> <tr><td>0-1</td><td>Ditto</td></tr> </table> <p>OUT4 (CN3-32 and CN3-33) output reverse select</p> <table border="1"> <tr><td>0-1</td><td>Ditto</td></tr> </table>	0	Does not inverse	1	Inverse	0-1	Ditto	0-1	Ditto	0-1	Ditto																						
0	Does not inverse																																
1	Inverse																																
0-1	Ditto																																
0-1	Ditto																																
0-1	Ditto																																
P□522	Output port signal reverse select 2	—	—	0000	N																												
	<p>H Bit 3 Bit 2 Bit 1 Bit 0</p> <p>OUT5 (CN3-34 and CN3-35) output reverse select</p> <table border="1"> <tr><td>0-1</td><td>Ditto</td></tr> </table> <p>OUT6 (CN3-36 and CN3-37) output reverse select</p> <table border="1"> <tr><td>0-1</td><td>Ditto</td></tr> </table> <p>Reserved</p>	0-1	Ditto	0-1	Ditto																												
0-1	Ditto																																
0-1	Ditto																																
P□600	RS-485 communication parameter selection switch	—	—	0151	Y																												
	<p>H Bit 3 Bit 2 Bit 1 Bit 0</p> <p>Communication baud rate select</p> <table border="1"> <tr><td>0</td><td>4800 bps</td></tr> <tr><td>1</td><td>9600 bps</td></tr> <tr><td>2</td><td>19200 bps</td></tr> <tr><td>3</td><td>38400 bps</td></tr> </table> <p>Communication protocol select</p> <table border="1"> <tr><td>0</td><td>7, N, 2</td><td rowspan="5">Modbus, ASCII</td></tr> <tr><td>1</td><td>7, E, 1</td></tr> <tr><td>2</td><td>7, O, 1</td></tr> <tr><td>3</td><td>8, N, 2</td></tr> <tr><td>4</td><td>8, E, 1</td></tr> <tr><td>5</td><td>8, O, 1</td><td rowspan="4">Modbus, RTU</td></tr> <tr><td>6</td><td>8, N, 2</td></tr> <tr><td>7</td><td>8, E, 1</td></tr> <tr><td>8</td><td>8, O, 1</td></tr> </table> <p>Reversed</p> <p>Reversed</p>	0	4800 bps	1	9600 bps	2	19200 bps	3	38400 bps	0	7, N, 2	Modbus, ASCII	1	7, E, 1	2	7, O, 1	3	8, N, 2	4	8, E, 1	5	8, O, 1	Modbus, RTU	6	8, N, 2	7	8, E, 1	8	8, O, 1				
0	4800 bps																																
1	9600 bps																																
2	19200 bps																																
3	38400 bps																																
0	7, N, 2	Modbus, ASCII																															
1	7, E, 1																																
2	7, O, 1																																
3	8, N, 2																																
4	8, E, 1																																
5	8, O, 1	Modbus, RTU																															
6	8, N, 2																																
7	8, E, 1																																
8	8, O, 1																																
P□601	RS-485 communication axis address	1 ~ 127	—	1 (A axis)	Y	2 (b axis)																											
P□602	RS-485 communication timeout parameter	0 ~ 1000	100 ms	0	N																												
P□603	CANopen communication	—	—	0004	Y																												

Parameter No.	Name	Setting range	Setting unit	Factory setting	Power reboot	Remarks																				
	parameter selection switch																									
	<p>H Bit 3 Bit 2 Bit 1 Bit 0</p> <table border="1"> <tr><th colspan="2">CAN communication baud rate</th></tr> <tr><td>0</td><td>50K bps</td></tr> <tr><td>1</td><td>100K bps</td></tr> <tr><td>2</td><td>125K bps</td></tr> <tr><td>3</td><td>250K bps</td></tr> <tr><td>4</td><td>500K bps</td></tr> <tr><td>5</td><td>1M bps</td></tr> </table> <p>Reserved</p> <p>Reserved</p> <table border="1"> <tr><th colspan="2">CANopen communication enable switch</th></tr> <tr><td>0</td><td>Disable CANopen communication</td></tr> <tr><td>1</td><td>Enable CANopen communication</td></tr> </table>	CAN communication baud rate		0	50K bps	1	100K bps	2	125K bps	3	250K bps	4	500K bps	5	1M bps	CANopen communication enable switch		0	Disable CANopen communication	1	Enable CANopen communication					
CAN communication baud rate																										
0	50K bps																									
1	100K bps																									
2	125K bps																									
3	250K bps																									
4	500K bps																									
5	1M bps																									
CANopen communication enable switch																										
0	Disable CANopen communication																									
1	Enable CANopen communication																									
P□604	CANopen communication axis address	1 ~ 127	—	1 (A axis)	Y	2 (b axis)																				
P□605	Metratrolink communication parameter	—	—	0011	Y																					
	<p>H Bit 3 Bit 2 Bit 1 Bit 0</p> <table border="1"> <tr><th colspan="2">Communication speed setting</th></tr> <tr><td>0</td><td>4M bps (M-I)</td></tr> <tr><td>1</td><td>10M bps (M-II)</td></tr> </table> <table border="1"> <tr><th colspan="2">Transmission byte setting</th></tr> <tr><td>0</td><td>17 bytes</td></tr> <tr><td>1</td><td>32 bytes</td></tr> </table> <table border="1"> <tr><th colspan="2">Parameter mode</th></tr> <tr><td>0</td><td>Standard mode</td></tr> <tr><td>1</td><td>YASKAWA mode</td></tr> </table> <p>Reserved</p>	Communication speed setting		0	4M bps (M-I)	1	10M bps (M-II)	Transmission byte setting		0	17 bytes	1	32 bytes	Parameter mode		0	Standard mode	1	YASKAWA mode							
Communication speed setting																										
0	4M bps (M-I)																									
1	10M bps (M-II)																									
Transmission byte setting																										
0	17 bytes																									
1	32 bytes																									
Parameter mode																										
0	Standard mode																									
1	YASKAWA mode																									
P□606	Metratrolink station address	0000 - 001F	—	0001	Y	0001 (b axis)																				
P□620	Linear acceleration	1 ~ 65535	10000 p/s/s	100	N																					
P□621	Linear deceleration	1 ~ 65535	10000 p/s/s	100	N																					
P□622	Emergency deceleration	1 ~ 65535	10000 p/s/s	10000	N																					
P□623	External positioning displacement distance	-1073741823 ~ +1073741823	1 reference unit	100	N																					
P□625	Zero return mode setting	—	—	1	Y																					

Parameter No.	Name	Setting range	Setting unit	Factory setting	Power reboot	Remarks
P□626	Reference point seeking switch speed	0 ~ 65535	100 p/s	150	Y	
P□627	Zero return closing speed	0 ~ 65535	100 p/s	50	Y	
P□628	Zero return displacement distance				Y	

Remarks:

1. Parameter mode

Standard mode (P□605.2 = 0):

Parameter access address is parameter No. in the table (decimal)

2. YASKAWA mode (P□605.2 = 1):

Parameter access address reflects partly YASKAWA common parameters and the remaining addresses use parameter No. in the table (hexadecimal)

Reflection Parameter Table:

Reflection Parameter No. (P□605.2=1)	Name	Original parameter No. (P□605.2=0)	Reflection Parameter No. (P□605.2=1)	Name	Original parameter No. (P□605.2=0)
P□100	Speed loop gain	P□100	P□506	Brake command latency time when servo is OFF	P□508
P□101	Speed loop integral	P□101	P□50A	Input signal selection 1	P□509
P□102	Position loop gain	P□102	P□50B	Input signal selection 2	P□510
P□212	Encoder frequency divider	P□201	P□50E	Output signal selection 1	P□513
P□20E	Electronic gear numerator	P□202	P□50F	Output signal selection 2	P□514
P□210	Electronic gear denominator	P□203	P□510	Output signal selection 3	P□515

Examples:

In standard mode (P□605.2 = 0), speed loop gain parameter access address is 100 (hexadecimal 0x0064) and torque reference filtering time parameter access address is 401 (hexadecimal 0x0191);

In YASKAWA mode (P□605.2 = 1), speed loop gain parameter access address is 256 (hexadecimal 0x0100) and torque reference filtering time parameter access address is 1025 (hexadecimal 0x0401).

Appendix C List of Alarm Display

Alarm display	ALM output	Alarms	Alarm contents	Clear or not
□01	H	Encoder PA, PB, PC disconnection	Encoder disconnection or cable welding problem.	Clear
□02	H	Encoder PU, PV, PW disconnection	Encoder disconnection or cable welding problem.	Clear
□03	H	Overload	Continuous running at a certain torque exceeding the rated value	Clear
□04	H	A/D switch channel abnormal	A/D switch channel abnormal	Clear
□05	H	PU, PV, PW false code	PU, PV, PW signals are all high or low	Clear
□06	H	PU, PV, PW phases incorrect	PU, PV, PW signals are all high or low	Clear
□10	H	Overcurrent	Servo drive IPM module current is overlarge.	Clear
□11	H	Overvoltage	Servo drive main circuit voltage is too high.	No
□12	H	Undervoltage	Servo drive main circuit voltage is too low.	No
□13	H	Parameter damage	EEROM data in servo drive is abnormal.	Clear
□14	H	Over-speed	Servo motor speed is extremely high	Clear
□15	H	Deviation counter overflow	Internal position deviation counter overflow	Clear
□16	H	Position deviation is overlarge	Position deviation pulse exceeds the set value of parameter P□504.	Clear
□17	H	Electronic gear fault	Electronic gear is unreasonably set or pulse frequency is too high	Clear
□18	H	1st channel of current detection is abnormal	Current detection abnormal	Clear
□19	H	2nd channel of current detection is abnormal	Current detection abnormal	Clear
□22	H	Motor model is incorrect	Servo drive parameters do not match with those of motor	Clear
□23	H	Servo drive does not match with motor	Servo drive does not match with motor	Clear
□25	H	Bus encoder multi-coil information error	Multi-coil information error	Clear
□26	H	Bus encoder multi-coil information overflow	Multi-coil information overflow	Clear
□27	H	Bus encoder battery alarm 1	Battery voltage is lower than 2.5 V, multi-coil information is lost	Clear
□28	H	Bus encoder battery alarm 2	Battery voltage is lower than 3.1 V, battery voltage is relatively low	Clear
□30	H	Bleeder resistor disconnection alarm	Braking resistor damage.	Clear
□31	H	Regeneration overload	Regeneration processing circuit is abnormal.	No
□33	H	Momentary outage alarm.	There is outage of over one power cycle under AC current.	Clear
□34	H	Rotary transformer is abnormal	Rotary transformer communication is abnormal.	Clear
□40	H	Bus encoder communication is abnormal	Servo drive and encoder cannot realize communication.	Clear
□41	H	Bus encoder overspeed	When power is ON, encoder rotates at high speed	Clear

Alarm display	ALM output	Alarms	Alarm contents	Clear or not
□42	H	Bus encoder absolute status error	Encoder damage or encoder decoding circuit damage	Clear
□43	H	Bus encoder counting error	Encoder damage or encoder decoding circuit damage	Clear
□44	H	Check error in bus encoder control field	Encoder signal is interrupted or encoder decoding circuit damage	Clear
□45	H	Check error in bus encoder communication data	Encoder signal is interrupted or encoder decoding circuit damage	Clear
□46	H	Stop bit error in bus encoder status field	Encoder signal is interrupted or encoder decoding circuit damage	Clear
□47	H	Stop bit error in bus encoder SFOME	Encoder signal is interrupted or encoder decoding circuit damage	Clear
□48	H	Bus encoder data are not initialized	Bus encoder SFOME data are null	Clear
□49	H	Sum check error in bus encoder data	Sum check in bus encoder EEPROM data is abnormal	Clear
□60	H	MODBUS communication timeout	Drive fails to accept data normally at the set time in P□602	Clear
□61	H	CANopen master station heartbeat timeout	Drive fails to accept master station heartbeat message normally at the set time	Clear
□70	H	Drive overheat alarm	Drive internal IPM module temperature is too high	Clear
□90	H	Software does not match with hardware	Parameter is wrongly set or software does not match with hardware	No
□--	L	No error display	Display normal action status	Clear

Note: 1. "□" in alarm display may be "A" or "b", referring to A axis alarm or b axis alarm respectively

Appendix D Guidelines for Motor Model by Users





Operation steps	Operation instruction	Operation key	Display after operation
1	After energizing, gently press M function key to switch to A axis auxiliary function mode.	M	FA000
2	Gently press “^” key for four times and set FA004.	^	FA004
3	Gently press SET key to enter password operation.	SET	-P in-
4	Long press (continuously for over 1 s) SET key to set password.	SET	00000
5	Import password 26753 and set password at each bit with Shift key.		26753
6	Long press (continuously for over 1 s) SET key to confirm password.	SET	-P in-
7	Gently press SET key to exit password operation.	SET	FA004
8	Gently press M function key for several times to switch to A axis parameter setting mode.	M	PA000
9	Gently press “^” key for six times and set FA006.	^	PA006
10	<p>Press SET key to display current PA000 data. The decimal point in bit 0 currently displayed flickers. Set motor manufacturer and encoder type with Shift key and “^” key.</p> 	SET	
11	Press SET to return to the display of FA006.		PA006
12	Gently press “v” key once to set FA005.	v	PA005
13	Gently press SET key to start motor model code setting.	SET	00039
14	Modify the value according to appendix (motor adaption)		

	table) and set value at each bit with Shift key.		
15	Gently press SET key to exit motor model code setting.		

Note:

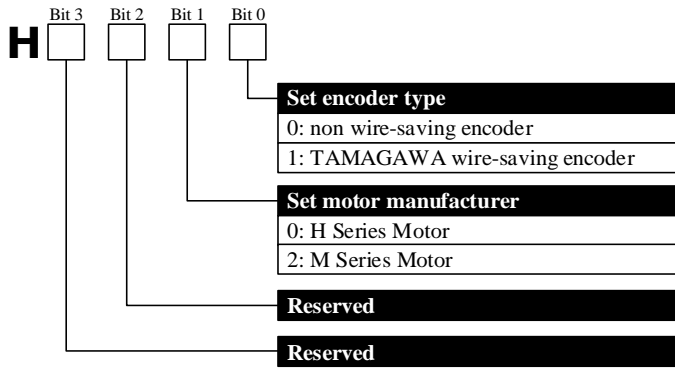
1. In case of double-axis servo drive, M function key should be press for a long time (continuously for above 1 s) during setting of b axis motor model to switch to b axis parameter and then follow step 9-12.

2. After setting motor model code, it is required to turn off and reboot servo drive to make modified parameters effective.

Motor Adaption Table

Note: Before selecting motor model, please set motor manufacturer and encoder type first which can both be set via PA006.

1: M Series Motor

If the motor is M Series Motor, refer to PA006 setting below:

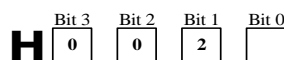
**Set encoder type**

0: non wire-saving encoder

1: TAMAGAWA wire-saving encoder

Motor model	Torque N•m	Rotation speed rpm	Power kW	Motor type Pn005
60ST-M00630	0.637	3000	0.2	0
60ST-M01330	1.27	3000	0.4	1
60ST-M01930	1.91	3000	0.6	2
80ST-M01330	1.27	3000	0.4	3
80ST-M02430	2.39	3000	0.75	4
80ST-M03520	3.5	2000	0.73	5
80ST-M04025	4.0	2500	1.0	6
90ST-M02430	2.4	3000	0.75	7
90ST-M03520	3.5	2000	0.73	8
90ST-M04025	4.0	2500	1.0	9
110ST-M02030	2.0	3000	0.6	10
110ST-M04020	4.0	2000	0.8	11
110ST-M04030	4.0	3000	1.2	12
110ST-M05030	5.0	3000	1.5	13

110ST-M06020	6.0	2000	1.2	14
110ST-M06030	6.0	3000	1.8	15
130ST-M04025	4.0	2500	1.0	16
130ST-M05025	5.0	2500	1.3	17
130ST-M06025	6.0	2500	1.5	18
130ST-M07725	7.7	2500	2.0	19
130ST-M10010	10.0	1000	1.0	20
130ST-M10015	10.0	1500	1.5	21
130ST-M10025	10.0	2500	2.6	22
130ST-M15015	15.0	1500	2.3	23
130ST-M15025	15.0	2500	3.8	24
180ST-M17215	17.2	1500	2.7	25
180ST-M19015	19.0	1500	3.0	26
180ST-M21520	21.5	2000	4.5	27
180ST-M27010	27.0	1000	2.9	28
180ST-M27015	27.0	1500	4.3	29
180ST-M35010	35	1000	3.7	30
180ST-M35015	35.0	1500	5.5	31

2. H Series Motor

If the motor is H Series Motor, refer to PA006 setting below:

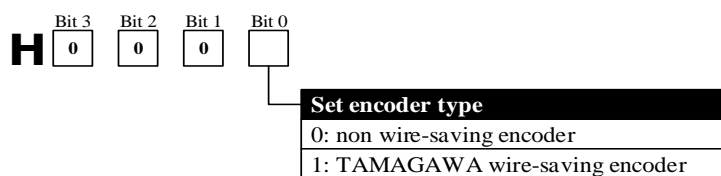

Motor model	Torque N•m	Rotation speed rpm	Power kW	Motor type Pn005
80ST-M01330LF1B	1.3	3000	0.4	0
80ST-M02430LF1B	2.4	3000	0.75	1
80ST-M03330LF1B	3.3	3000	1.0	2
110ST-M02030LFB	2.0	3000	0.6	3
110ST-M04030LFB	4.0	3000	1.2	4
110ST-M05030LFB	5.0	3000	1.5	5
110ST-M06020LFB	6.0	2000	1.2	6

110ST-M06030LFB	6.0	3000	1.8	7
130ST-M04025LFB	4.0	2500	1.0	8
130ST-M05025LFB	5.0	2500	1.3	10
130ST-M06025LFB	6.0	2500	1.5	11
130ST-M07720LFB	7.7	2000	1.6	12
130ST-M07725LFB	7.7	2500	2.0	13
130ST-M07730LFB	7.7	3000	2.4	14
130ST-M10015LFB	10	1500	1.5	15
130ST-M10025LFB	10.0	2500	2.5	16
130ST-M15015LFB	15.0	1500	2.3	17
130ST-M15025LFB	15.0	2500	3.8	18
150ST-M15025LFB	15.0	2500	3.8	19
150ST-M18020LFB	18.0	2000	3.6	20
150ST-M23020LFB	23.0	2000	4.7	21
150ST-M27020LFB	27.0	2000	5.4	22